

M-Pulse Microwave

Silicon Bipolar MMIC Cascadable Amplifier

MP4TD0300

V4.00

Features

- Cascadable 50Ω Gain Block
- 3dB Bandwidth: DC to 2.0 GHz
- 12 dB Typical Gain @ 1.0 GHz
- Unconditionally Stable ($k > 1$)

Description

M-Pulse's MP4TD0300 is a high performance silicon bipolar MMIC chip. The MP4TD0300 is designed for use where a general purpose 50Ω gain block is required. Typical applications include narrow and wide band IF and RF amplifiers in industrial and military applications.

The MP4TD0300 is fabricated using a 10 GHz f_T silicon bipolar technology that features gold metalization and IC passivation for increased performance and reliability.

Chip Outline Drawing^{1,2,3,4}

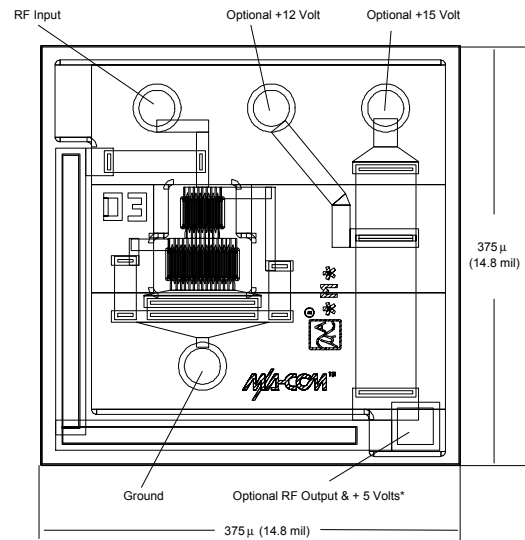

Notes: (unless otherwise specified)

1. Chip Thickness is 120 μm; 4.8 mils
2. Bond Pads are 40 μm; 1.6 mils typical in diameter
3. Output Contact & +DC Voltage Is Normally Made On Backside Of Chip At Die Attach
4. Tolerance: μm .xx = ±.13; mil .x = ±.5

Ordering Information

Model No.	Type of Carrier
MP4TD0300G	GEL PACK
MP4TD0300W	Waffle Pack

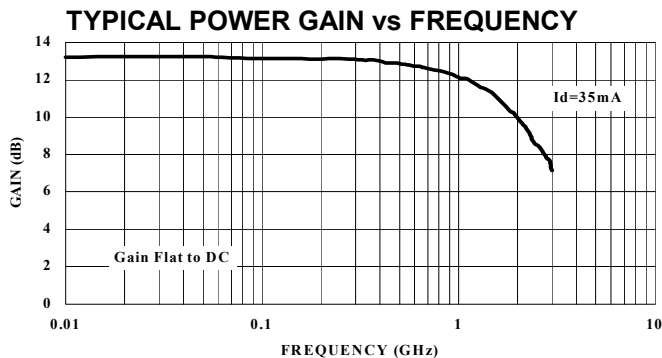

Electrical Specifications @ $T_A = +25^\circ\text{C}$, $I_d = 35 \text{ mA}$; $Z_0 = 50\Omega$

Symbol	Parameters	Test Conditions	Units	Min.	Typ.	Max.
G_p	Power Gain ($ S_{21} ^2$)	$f = 0.1 \text{ GHz}$	dB	-	13.0	-
ΔG_p	Gain Flatness	$f = 0.1 \text{ to } 1.5 \text{ GHz}$	dB	-	± 1.0	-
f_{3dB}	3 dB Bandwidth	-	GHz	-	2.0	-
SWR_{in}	Input SWR	$f = 0.1 \text{ to } 3.0 \text{ GHz}$	-	-	1.4	-
SWR_{out}	Output SWR	$f = 0.1 \text{ to } 2.0 \text{ GHz}$	-	-	1.4	-
P_{1dB}	Output Power @ 1dB Gain Compression	$f = 1.0 \text{ GHz}$	dBm	-	10.0	-
NF	50 Ω Noise Figure	$f = 1.0 \text{ GHz}$	dB	-	5.5	-
IP_3	Third Order Intercept Point	$f = 1.0 \text{ GHz}$	dBm	-	23.0	-
t_d	Group Delay	$f = 1.0 \text{ GHz}$	ps	-	125	-
V_d	Device Voltage	-	V	4.5	5.0	5.5
dV/dT	Device Voltage Temperature Coefficient	-	mV/°C	-	-8.0	-

Specification Subject to Change Without Notice

M-Pulse Microwave

1

North America: Tel. (408) 432-1480
Fax (408) 432-3440

Absolute Maximum Ratings¹

Parameter	Absolute Maximum
Device Current	80 mA
Power Dissipation ^{2,3}	425 mW
RF Input Power	+13 dBm
Junction Temperature	200°C
Storage Temperature	-65°C to +150°C
Thermal Resistance: $\theta_{jms} = 150^\circ\text{C/W}$	

1. Exceeding these limits may cause permanent damage.
2. Mounting Surface Temperature (T_{MS}) = 25 °C.
3. Derate at 22.2 mW/°C for $T_{MS} > 181^\circ\text{C}$

Typical Bias Configuration

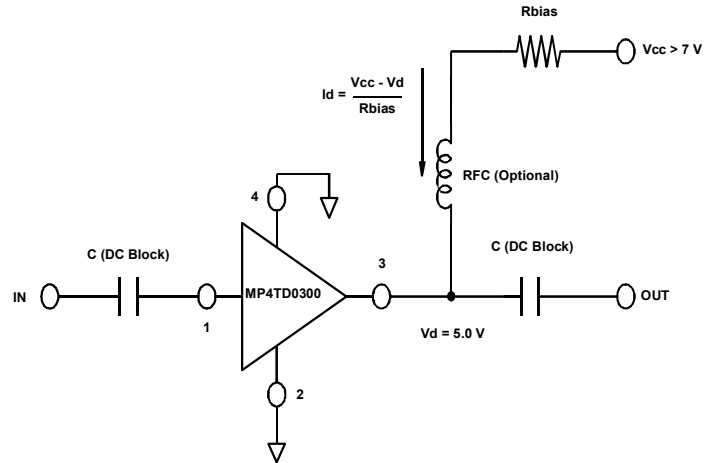

Typical Performance Curves @ $I_d = 35\text{ mA}$, $T_A = +25^\circ\text{C}$ (unless otherwise noted)

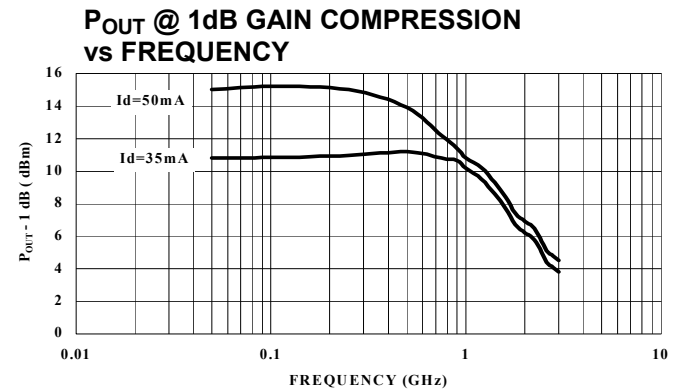
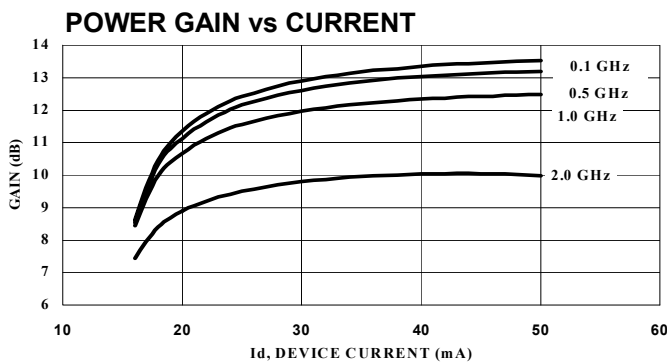
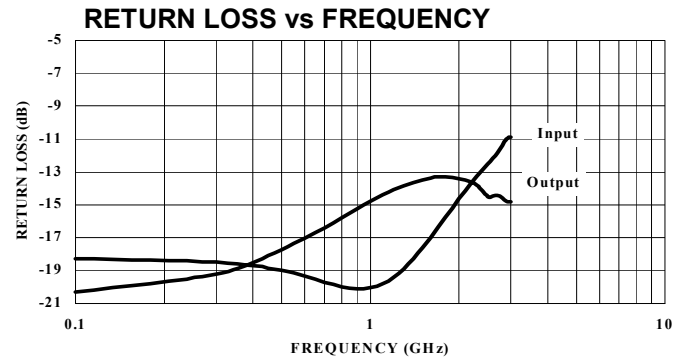
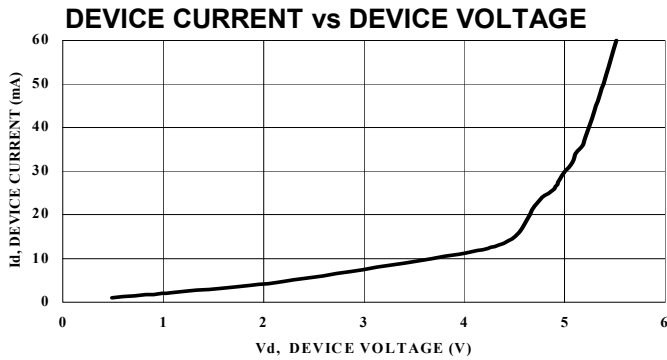

Specification Subject to Change Without Notice

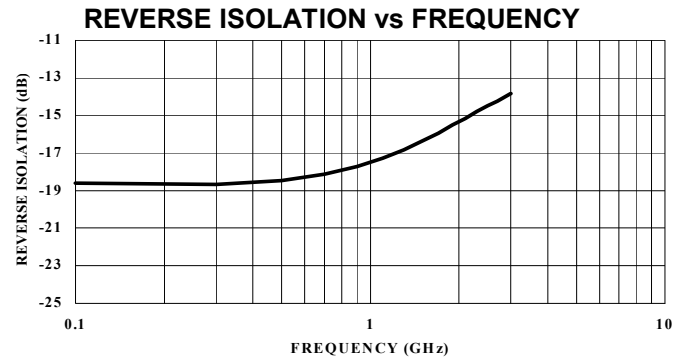
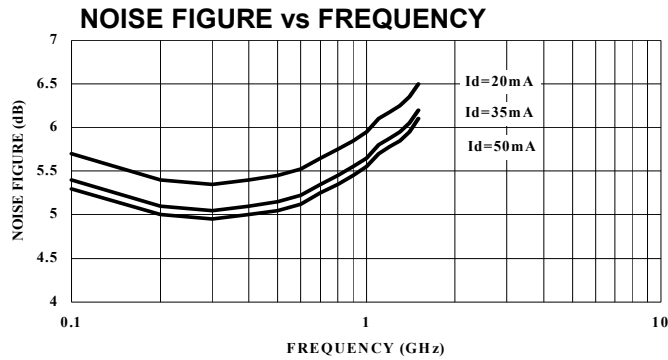

Typical Scattering Parameters
 $Z_0 = 50\Omega$, $T_A = +25^\circ\text{C}$, $I_D = 35\text{ mA}$

Frequency (GHz)	S11		S21		S12		S22	
	Mag.	Angle	Mag.	Angle	Mag.	Angle	Mag	Angle
0.1	0.119	177.7	4.54	0.1	0.114	0.1	0.096	-18.4
0.2	0.118	177.8	4.52	0.1	0.114	3.2	0.102	-30.7
0.4	0.115	175.0	4.45	0.1	0.117	6.6	0.119	-57.0
0.6	0.107	175.4	4.35	0.1	0.121	9.6	0.140	-78.7
0.8	0.099	179.4	4.21	0.1	0.126	12.3	0.162	-95.7
1.0	0.099	-174.0	4.06	0.1	0.133	13.9	0.181	-110.1
1.5	0.131	-162.5	3.60	0.9	0.152	15.8	0.210	-137.3
2.0	0.184	-166.8	3.11	0.7	0.171	14.3	0.212	-156.7
2.5	0.236	-178.4	2.67	0.5	0.189	11.3	0.194	-169.0
3.0	0.287	167.1	2.31	0.3	0.203	7.7	0.180	-178.3
3.5	0.340	151.8	3.03	0.2	0.215	3.6	0.172	174.5
4.0	0.395	137.0	1.80	0.7	0.224	-0.8	0.169	167.0
4.5	0.443	123.4	1.57	-0.6	0.232	-5.3	0.177	159.2
5.0	0.480	113.0	1.39	-0.1	0.235	-9.0	0.194	152.3

Specification Subject to Change Without Notice