

# T-1 3/4 PACKAGE PIN PHOTODIODE

**MID-56419**

## Description

The MID-56419 is a photodiode mounted in water clear end look plastic package and suitable for the variety wavelength.

## Package Dimensions

Unit: mm ( inches )

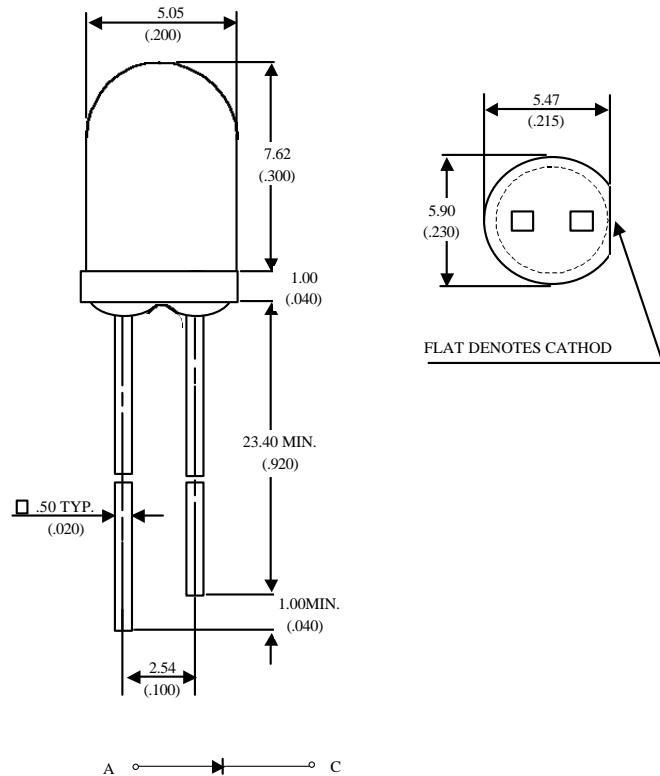

## Features

- High photo sensitivity
- Low junction capacitance
- High cut-off frequency
- Fast switching time
- Acceptance viwe angle : 60°

### Notes :

- 1.Tolerance is  $\pm 0.25$  mm (.010") unless otherwise noted.
- 2.Protruded resin under flange is 1.0 mm (.040") max.
- 3.Lead spacing is measured where the leads emerge from the package.

## Absolute Maximum Ratings

@  $T_A=25^\circ\text{C}$

Parameter	Maximum Rating	Unit
Power Dissipation	150	mW
Operating Temperature Range	-55°C to +100°C	
Storage Temperature Range	-55°C to +100°C	
Lead Soldering Temperature	260°C for 5 seconds	

**UNi**

Unity Opto Technology Co., Ltd.

02/04/2002

Optical-Electrical Characteristics

@ T<sub>A</sub>=25°C

Parameter	Test Conditions	Symbol	Min.	Type	Max.	Unit
Reverse Break Down Voltage	I <sub>R</sub> =100μA Ee=0	V <sub>(BR)R</sub>	30			V
Reverse Dark Current	V <sub>R</sub> =10V Ee=0	I <sub>D</sub>			30	nA
Open Circuit Voltage	λ=940nm Ee=0.1mW/cm <sup>2</sup>	V <sub>OC</sub>		350		mV
Rise Time	V <sub>R</sub> =10V λ=940nm	Tr		30		nsec
Fall Time	R <sub>L</sub> =50Ω	Tf		30		
Light Current	V <sub>R</sub> =5V , λ=940nm Ee=0.1mW/cm <sup>2</sup>	I <sub>L</sub>		12		μA
Total Capacitance	V <sub>R</sub> =3V , f=1MHZ Ee=0	C <sub>T</sub>		25		pF

Typical Optical-Electrical Characteristic Curves

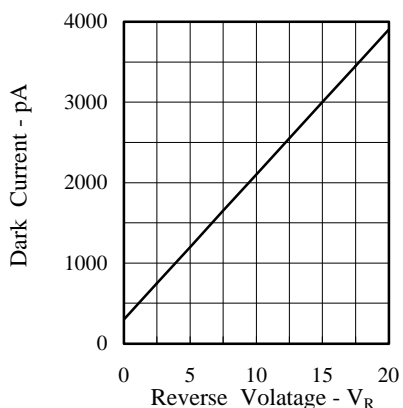

FIG.1 DARK CURRENT VS REVERSE VOLTAGE  
TEMP=25°C, Ee=0 mW/cm<sup>2</sup>

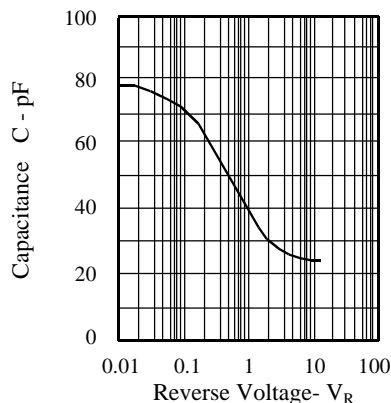

FIG.2 CAPACITANCE VS. REVERSE VOLTAGE  
F=1MHZ, Ee=0mW/cm<sup>2</sup>

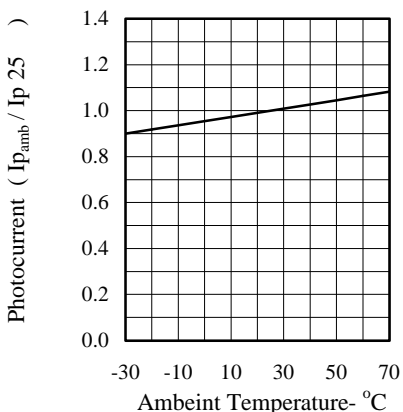

FIG.3 PHOTOCURRENT VS AMBIENT TEMPERATURE

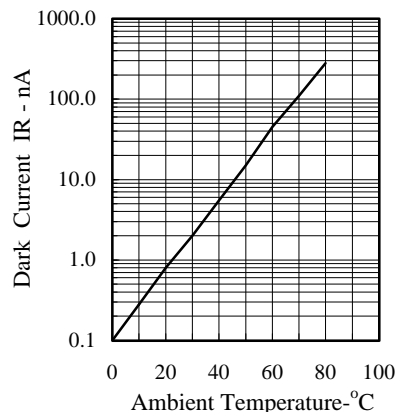

FIG.4 DARK CURRENT VS AMBIENT TEMPERATURE  
V<sub>R</sub>=10, Ee=0 mw/cm<sup>2</sup>

Typical Optical-Electrical Characteristic Curves

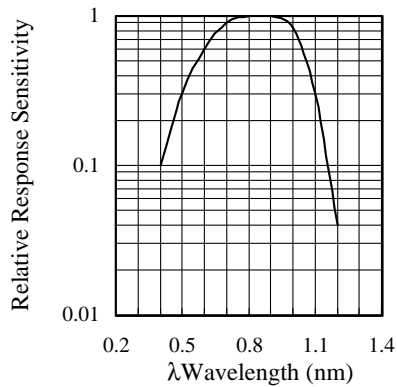

FIG.5 RELATIVE SPECTRAL SENSITIVITY VS. WAVELENGTH

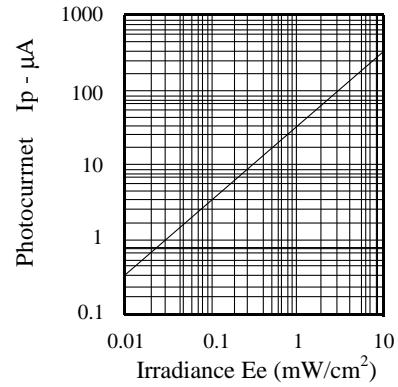

FIG.6 PHOTOCURRENT VS. IRRADIANCE = 950 nm

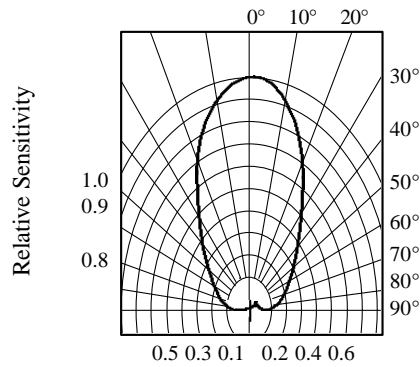

FIG.7 SENSITIVITY DIAGRAM

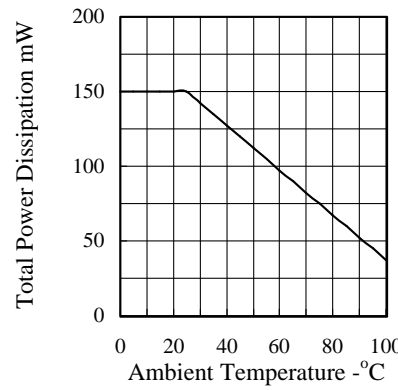

FIG.8 TOTAL POWER DISSIPATION VS. AMBIENT TEMPERATURE