

# Cree® 5-mm Round LED

## Model # LC503TWN1-50P-A1

### Data Sheet

50-degree, 5-mm round LED lamp in white color with water-transparent lens and stopper

#### Applications

- Advertising Signs
- Indicators
- LCD Back Light
- Illuminations

#### Absolute Maximum Ratings ( $T_A = 25^\circ\text{C}$ )

Items	Symbol	Absolute Maximum Rating	Unit
Forward Current	$I_F$	25	mA
Peak Forward Current <sup>Note</sup>	$I_{FP}$	100	mA
Reverse Voltage	$V_R$	5	V
Power Dissipation	$P_D$	100	mW
Operation Temperature	$T_{opr}$	-40 ~ +95	°C
Storage Temperature	$T_{stg}$	-40 ~ +100	°C
Lead Soldering Temperature	$T_{sol}$	Max. 260°C for 3 sec. max. (3 mm from the base of the epoxy bulb)	

**Note:** Pulse width  $\leq 0.1$  msec, duty  $\leq 1/10$ .

#### Typical Electrical & Optical Characteristics ( $T_A = 25^\circ\text{C}$ )

Characteristics	Symbol	Condition	Unit	Minimum	Typical	Maximum
Forward Voltage	$V_F$	$I_F = 20$ mA	V		3.4	4.0
Forward Voltage	$V_F$	$I_F = 1.0$ $\mu\text{A}$	V	1.7		2.5
Reverse Current	$I_R$	$V_R = 5$ V	$\mu\text{A}$			100
Luminous Intensity	$I_V$	$I_F = 20$ mA	mcd	1520	3000	
Chromaticity Coordinates	x	$I_F = 20$ mA			0.31	
	y	$I_F = 20$ mA			0.32	
50% Power Angle	2 $\theta_{1/2}$ H-H	$I_F = 20$ mA	deg		50	

## Standard Bins for LC503TWN1-50P-A1 ( $I_F = 20 \text{ mA}$ )

Lamps are sorted to luminous intensity ( $I_V$ ) and chromaticity coordinates (x,y) bins shown.

Orders for LC503TWN1-50P-A1 may be filled with any or all bins contained as below.

All luminous intensity ( $I_V$ ) and chromaticity coordinates (x,y) values shown and specified are at  $I_F = 20 \text{ mA}$ .

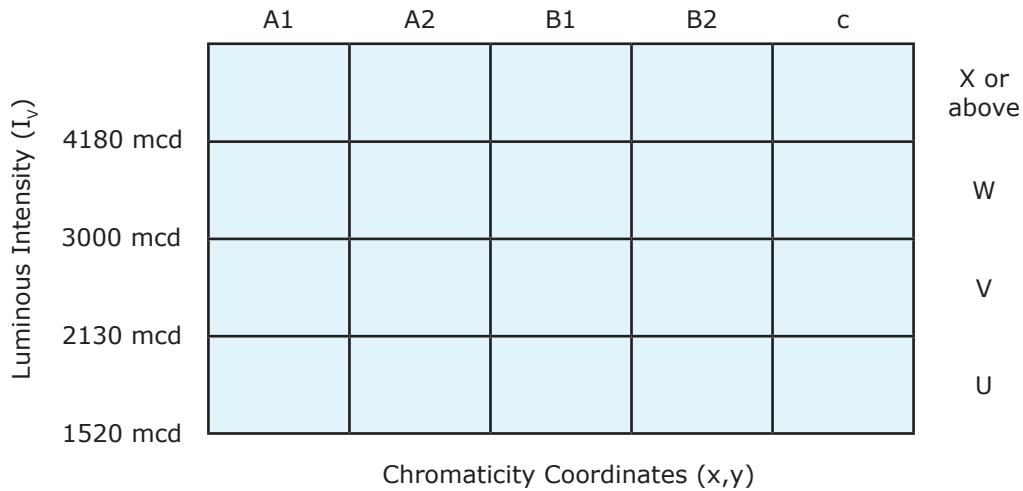

Rank	A1				A2				B1				
Chromaticity Coordinates	x	0.245	0.264	0.280	0.264	0.264	0.283	0.296	0.280	0.283	0.307	0.313	0.296
	y	0.229	0.267	0.248	0.220	0.267	0.305	0.276	0.248	0.305	0.337	0.297	0.276

Rank	B2				c				
Chromaticity Coordinates	x	0.307	0.330	0.330	0.313	0.330	0.361	0.356	0.330
	y	0.337	0.360	0.318	0.297	0.360	0.385	0.351	0.318

### Important Notes

1. All ranks will be included per delivery; rank ratio will be based on the dice distribution.
2. Pb content <1000 ppm.
3. Tolerance of measurement of luminous intensity is  $\pm 15\%$ .
4. Tolerance of measurement of the color coordinates is  $\pm 0.01$ .
5. Tolerance of measurement of  $V_F$  is  $\pm 0.05 \text{ V}$ .
6. Packaging methods are available for selection; please refer to the "Cree LED Lamp Packaging Standard" document.
7. Please refer to the "Cree LED Lamp Reliability Test Standards" document for reliability test conditions.
8. Please refer to the "Cree LED Lamp Soldering & Handling" document for information about how to use this LED product safely.

## CIE Chromaticity Diagram

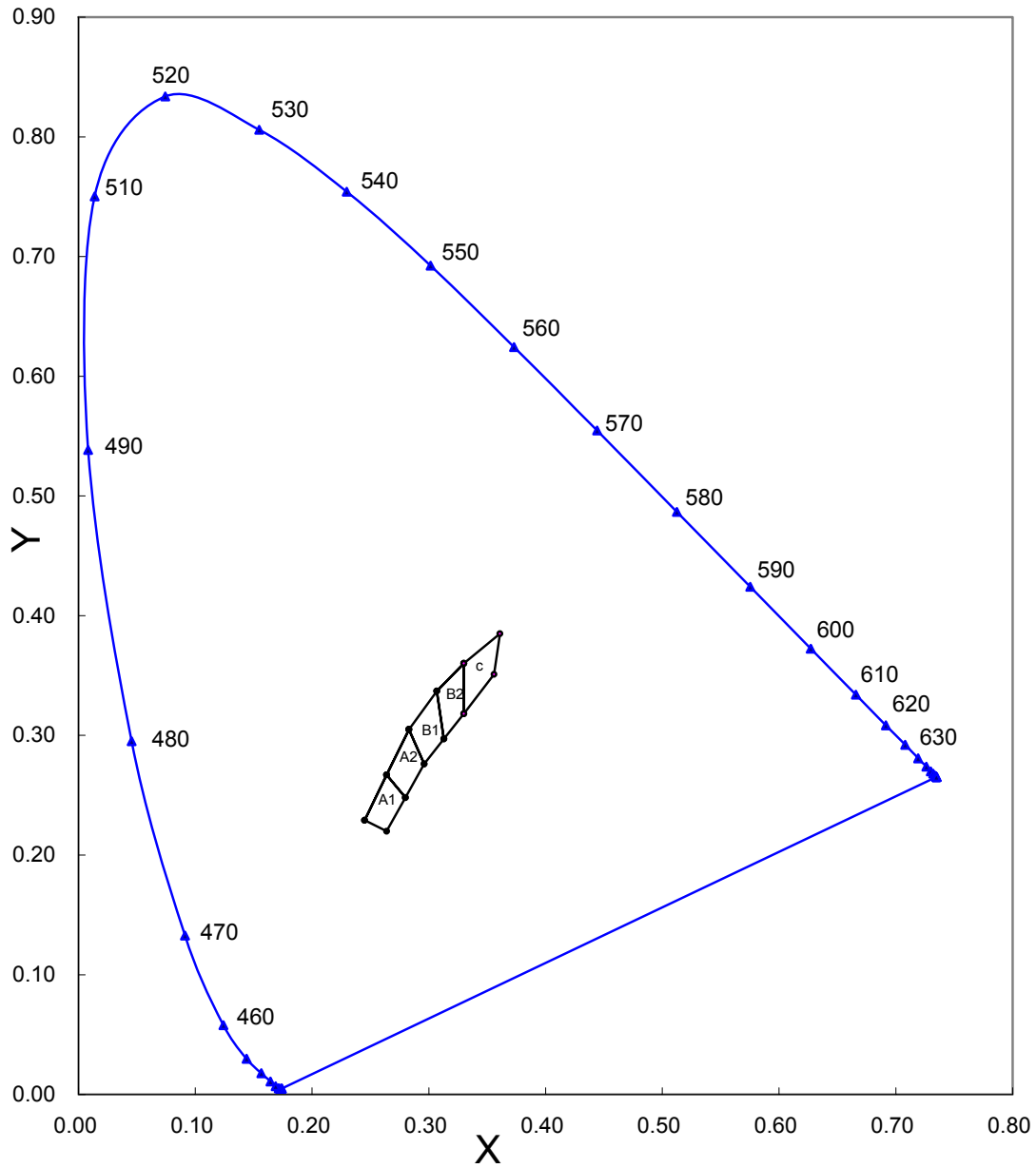

**Graphs**

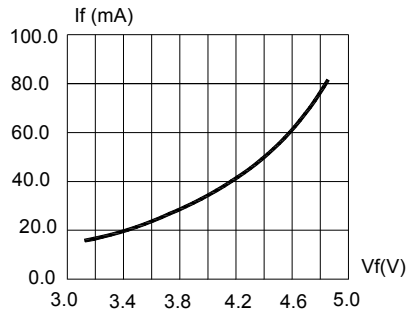

FIG.1 FORWARD CURRENT VS. FORWARD VOLTAGE.

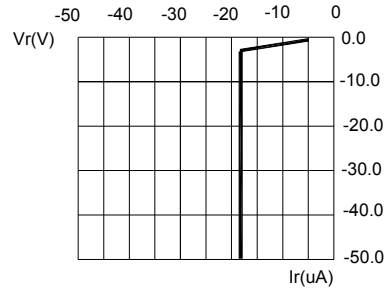

FIG.2 REVERSE CURRENT VS. REVERSE VOLTAGE.

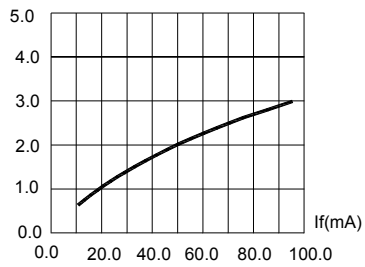

FIG.3 RELATIVE LUMINOUS INTENSITY VS. FORWARD CURRENT

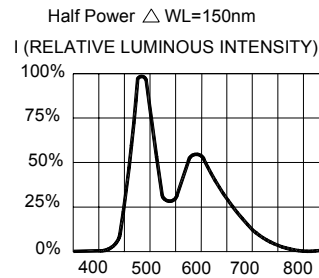

FIG.4 RELATIVE LUMINOUS INTENSITY VS. WAVELENGTH.

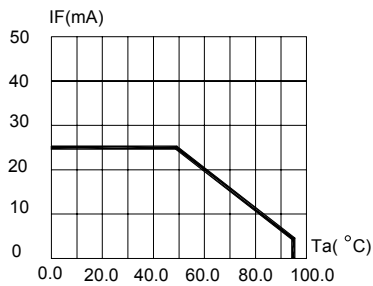

FIG.5 MAXIMUM FORWARD DC CURRENT VS AMBIENT TEMPERATURE (Tjmax=105 °C)

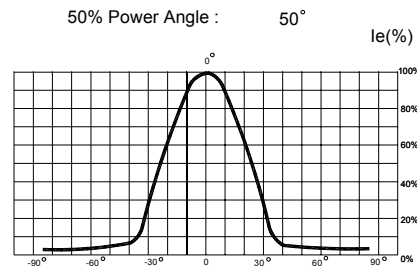

FIG.6 FAR FIELD PATTERN

## Mechanical Dimensions

All dimensions are in mm. Tolerance is  $\pm 0.25$  mm unless otherwise noted.

An epoxy meniscus may extend about 1.5 mm down the leads.

Burr around bottom of epoxy may be 0.5 mm max.

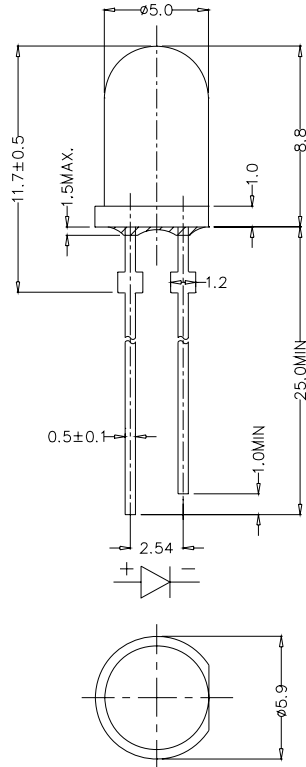

## Notes

### RoHS Compliance

The levels of environmentally sensitive, persistent biologically toxic (PBT), persistent organic pollutants (POP), or otherwise restricted materials in this product are below the maximum concentration values (also referred to as the threshold limits) permitted for such substances, or are used in an exempted application, in accordance with EU Directive 2002/95/EC on the restriction of the use of certain hazardous substances in electrical and electronic equipment (RoHS), as amended through April 21, 2006.

### Vision Advisory Claim

Users should be cautioned not to stare at the light of this LED product. The bright light can damage the eye.

## Kit Number System

Cree LED lamps are tested and sorted into performance bins. A bin is specified by ranges of color, forward voltage, and brightness. Sorted LEDs are packaged for shipping in various convenient options. Please refer to the "Cree LED Lamp Packaging Standard" document for more information about shipping and packaging options.

Cree LEDs are sold by order codes in combinations of bins called kits. Order codes are configured in the following manner:

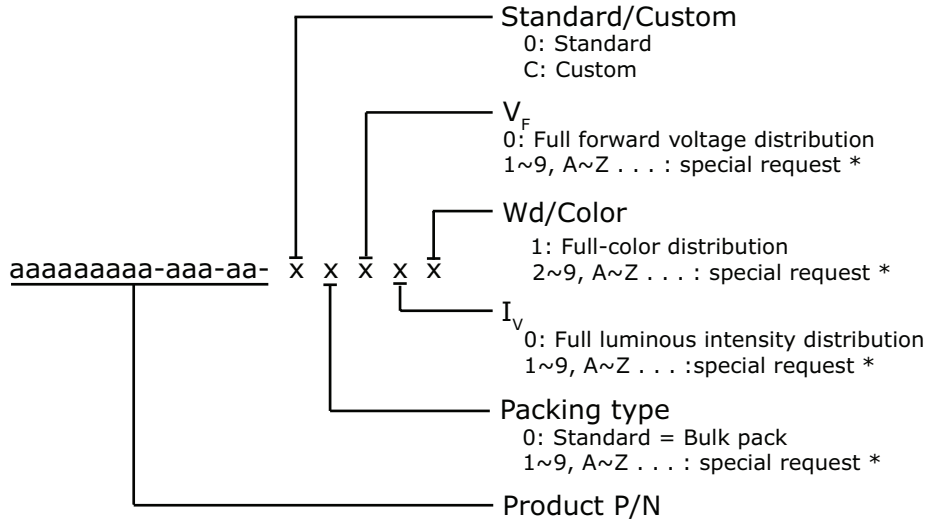

\* Contact your Cree sales representative for ordering information.

## Standard Available Kits\*

Kit Number	Description
LC503TWN1-50P-A1-00001	5mm Round 50 White, FULL RANK, Bulk Pack
LC503TWN1-50P-A1-00002	5mm Round 50 White, A1, A2, B1, B2, Bulk Pack

\* Please contact your Cree representative about the availability of non-standard kits.