

LC503QBL1-30H-A

Features

5mm Package
 High Optical Power
 High Luminous Intensity
 Water Clear Lens
 All Plastic Mold Type
 PRELIMINARY SPEC

Applications

Outdoor Message Centers
 VMS
 Automotive Interior Lighting
 Traffic Signals
 Pedestrian Signals
 Decorative Lighting



ATTENTION

OBSERVE PRECAUTIONS
 ELECTROSTATIC
 SENSITIVE DEVICES

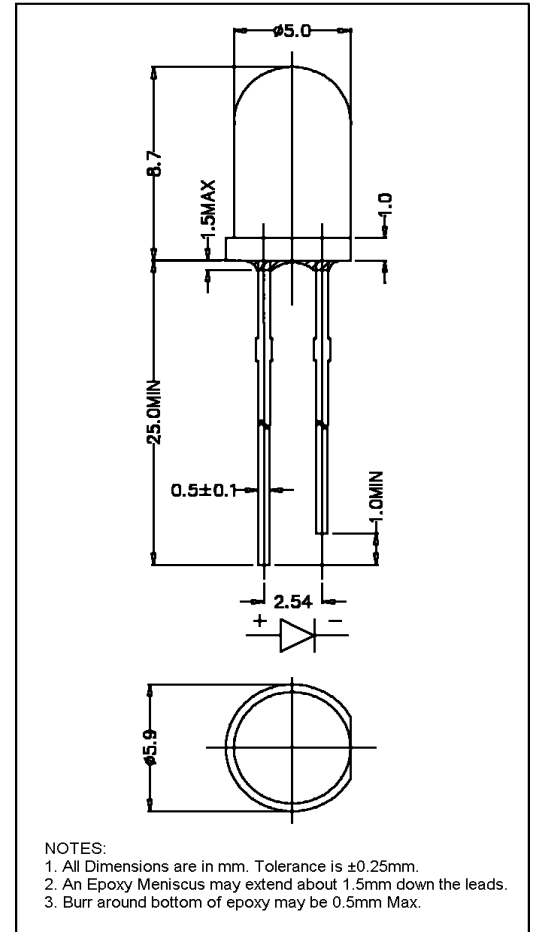

Maximum Ratings (Ta=25°C)

Characteristic	Symbol	Max.	Unit
Forward Current	I_F	25	mA
Reverse Voltage	V_R	5	V
Power Dissipation	P_D	105.00	mW
Operating Temperature	T_{opr}	-20 ~ +75	°C
Storage Temperature	T_{stg}	-30 ~ +80	°C
Soldering Temperature	T_{sol}	260	°C
Soldering Time	-	for 3 sec. max	-

Opto-Electrical Characteristics (Ta=25°C)

Characteristic	Symbol	Test Condition	Min	Typ	Max	Unit
Forward Voltage	V_F	$I_F=20\text{mA}$	-	3.60	4.20	V
Reverse Current	I_R	$V_R=5\text{V}$	-	-	100	μA
Luminous Intensity	I_v	$I_F=20\text{mA}$	770.00	2100.00	-	mcd
Viewing Angle	$2\theta^{1/2}$	-	-	30°	-	deg.
Peak Wavelength	λ_p	$I_F=20\text{mA}$	-	465	-	nm
Dominant Wavelength	λ_d	$I_F=20\text{mA}$	-	470	-	nm
Spectral Line Half Width	$\Delta\lambda$	$I_F=20\text{mA}$	-	28	-	nm

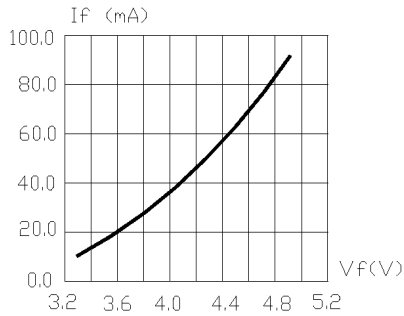

FIG.1 FORWARD CURRENT VS. FORWARD VOLTAGE.

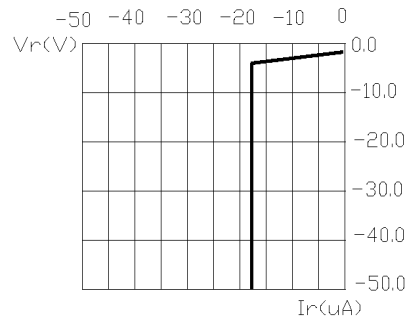

FIG.2 REVERSE CURRENT VS. REVERSE VOLTAGE.

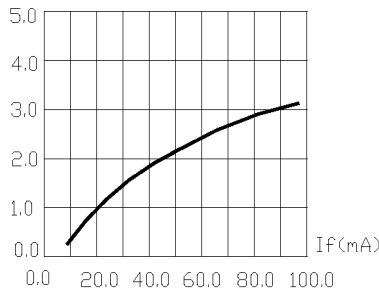

FIG.3 RELATIVE LUMINOUS INTENSITY VS. FORWARD CURRENT.

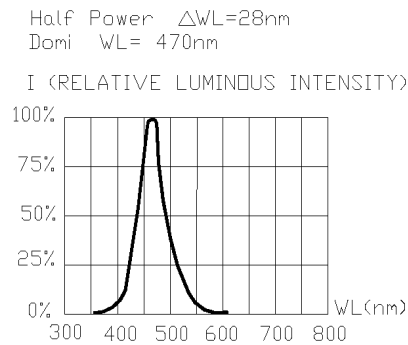

FIG.4 RELATIVE LUMINOUS INTENSITY VS. WAVELENGTH.

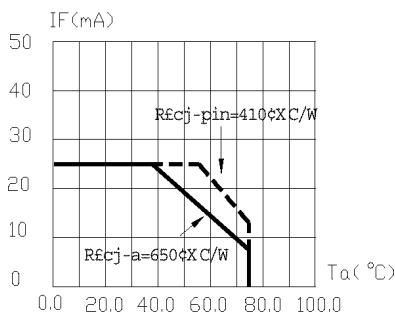

FIG.5 MAXIMUM FORWARD DC CURRENT VS AMBIENT TEMPERATURE (Tjmax=95°C)

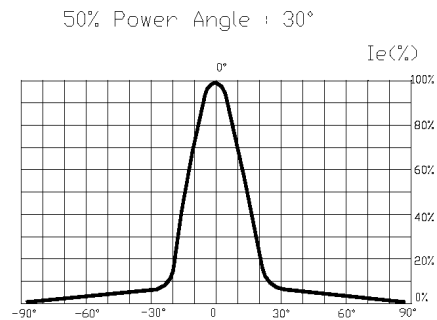

FIG.6 FAR FIELD PATTERN