

KVR100X64C2/256 100MHz SDRAM 168-Pin PC100 Memory Module

DESCRIPTION:

This document describes ValueRAM's 32M x 64-bit (256MB), CAS Latency 2 (CL2) SDRAM (Synchronous DRAM) 100MHz memory module. The components on this module include sixteen 16M x 8-bit (4M x 8-bit x 4 Bank / PC100 components) SDRAM components in TSOP packages. This 168-pin DIMM uses gold contact fingers and requires +3.3V. The electrical and mechanical specifications are as follows:

FEATURES:

- | | |
|--------------------------|---|
| ✓ CLK Cycle Time (tCC) | min. = 10ns (CAS Latency = 2) / max. = 1000ns |
| ✓ Row Cycle Time (tRC) | 70ns |
| ✓ CLK to Output (tSAC) | max. = 6ns (CAS Latency = 2) |
| ✓ Single Power Supply of | +3.3V (+/- .3V) |
| ✓ Power | 4.658 W (operating) |
| ✓ UL Rating | 94 V - 0 |

Note: The module defined in this data sheet is one of several configurations available under this part number. While all configurations are compatible, the DRAM combination and/or the module height may vary from what is described here. However, in no configuration will the module height exceed 1.375" (34.82mm).

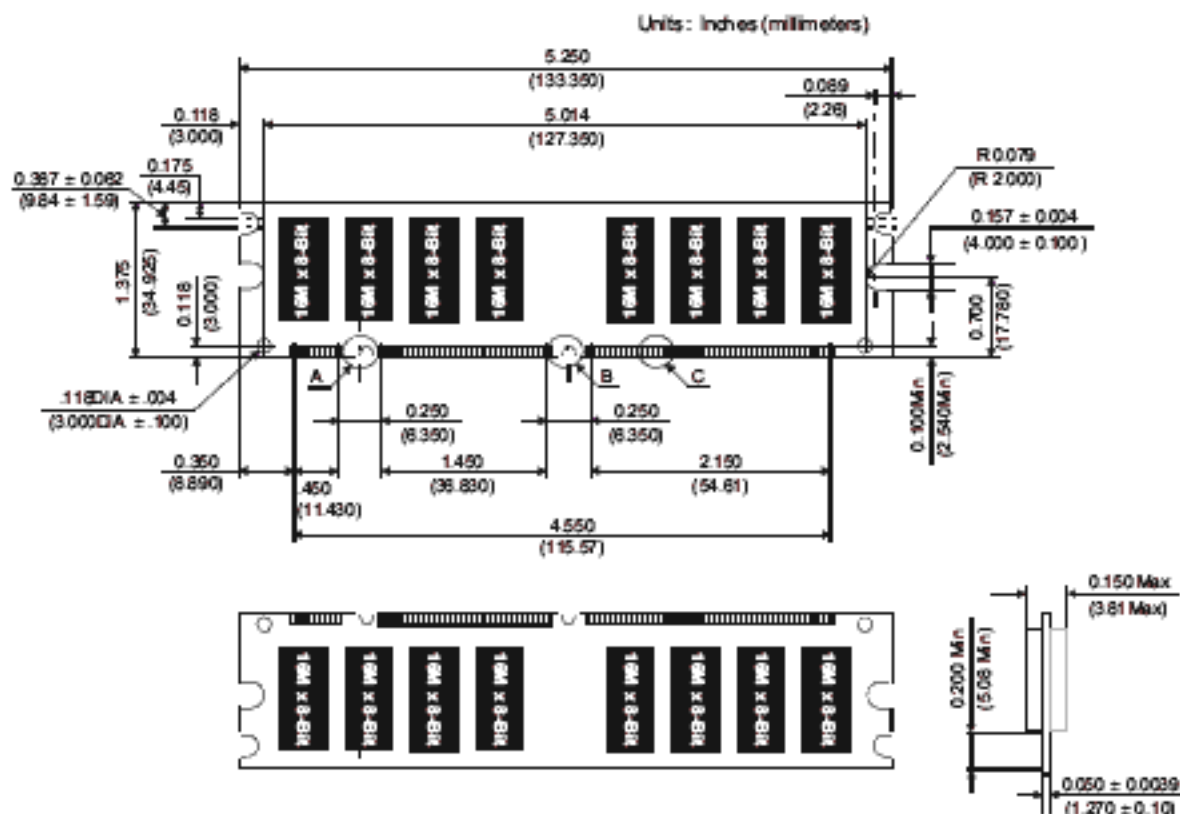

Figure 1: KVR100X64C2/256 168-Pin SDRAM Module