

Features

1. Mini-flat package.
2. High collector-emitter voltage
($V_{CEO}:300V$)
3. High current transfer ratio
($CTR:MIN.1000\%$ at $I_F=1mA, V_{CE}:2V$)
4. High isolation voltage between input and output
($Viso:3750V_{rms}$).

Applications

1. Telephone sets.
2. Copiers, facsimiles.
3. Interfaces with various power supply circuits, power distribution boards.
4. Hybrid substrates which require high density mounting.

Outside Dimension : Unit (mm)

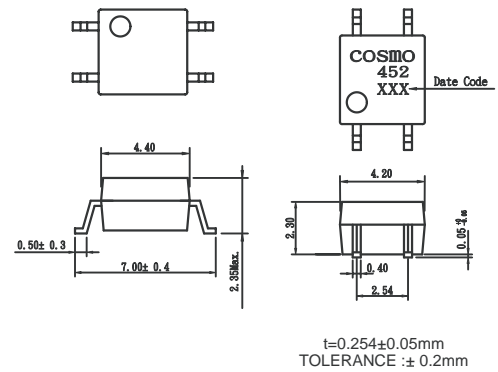

Schematic : Top View

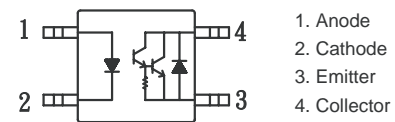

Absolute Maximum Ratings

($T_a=25^{\circ}C$)

Parameter		Symbol	Rating	Unit
Input	Forward current	I_F	50	mA
	Peak forward current	I_{FM}	1	A
	Reverse voltage	V_R	6	V
	Power dissipation	P	70	mW
Output	Collector-emitter voltage	V_{CEO}	300	V
	Emitter-collector voltage	V_{ECO}	0.1	V
	Collector current	I_C	150	mA
	Collector power dissipation	P_C	150	mW
Total power dissipation		P_{tot}	170	mW
Isolation voltage 1 minute		V_{iso}	3750	V_{rms}
Operating temperature		T_{opr}	-30 to +100	$^{\circ}C$
Storage temperature		T_{stg}	-40 to +125	$^{\circ}C$
Soldering temperature 10 seconds		T_{sol}	260	$^{\circ}C$

Electro-optical Characteristics

($T_a=25^{\circ}C$)

Parameter		Symbol	Conditions	MIN.	TYP.	MAX.	Unit
Input	Forward voltage	V_F	$I_F=10mA$	—	1.2	1.4	V
	Reverse current	I_R	$V_R=4V$	—	—	10	μA
	Terminal capacitance	C_t	$V=0, f=1kHz$	—	30	—	pF
Output	Collector dark current	I_{CEO}	$V_{CE}=200V, I_F=0$	—	—	1	μA
	Collector-emitter breakdown voltage	V_{CEO}	$I_C=0.1mA, I_F=0$	300	—	—	V
Transfer characteristics	Current transfer ratio	CTR	$I_F=1mA, V_{CE}=2V$	1000	—	—	%
	Collector-emitter saturation voltage	$V_{CE(sat)}$	$I_F=20mA, I_C=100mA$	—	—	1.5	V
	Isolation resistance	R_{iso}	DC500V, 40 TO 60%RH	5×10^{10}	10^{11}	—	ohm
	Floating capacitance	C_f	$V=0, f=1MHZ$	—	0.6	1.0	pF
	Response time (Rise)	t_r	$V_{CE}=2V, I_C=20mA, R_L=100ohm$	—	100	300	μs
	Response time (Fall)	t_f		—	20	100	μs

Fig.1 Forward Current vs. Ambient Temperature

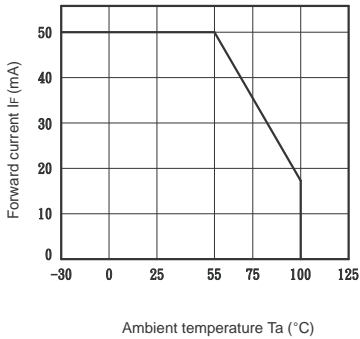

Fig.2 Collector Power Dissipation vs. Ambient Temperature

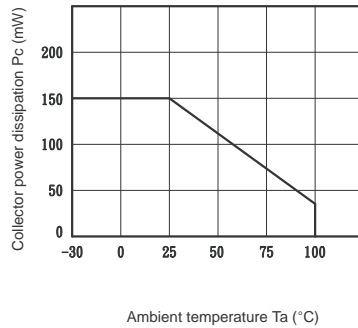

Fig.3 Peak Forward Current vs. Duty Ratio

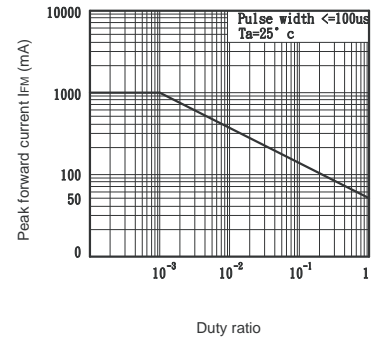

Fig.4 Forward Current vs. Forward Voltage

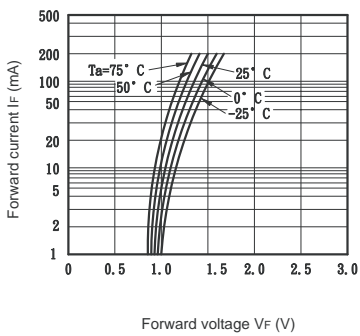

Fig.5 Current Transfer Ratio vs. Forward Current

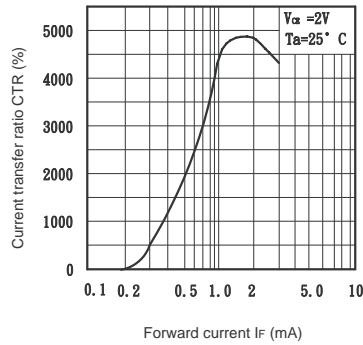

Fig.6 Collector Current vs. Collector-emitter Voltage

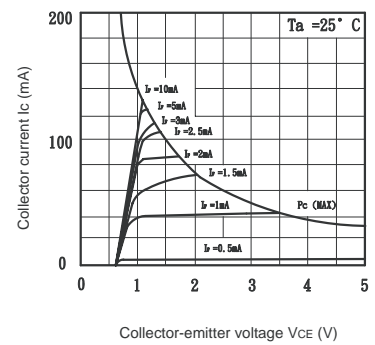

Fig.7 Relative Current Transfer Ratio vs. Ambient Temperature

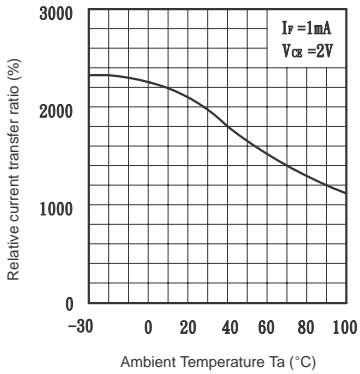

Fig.8 Collector-emitter Saturation Voltage vs. Ambient Temperature

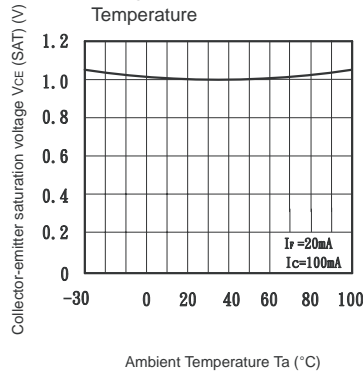

Fig.9 Collector Dark Current vs. Ambient Temperature

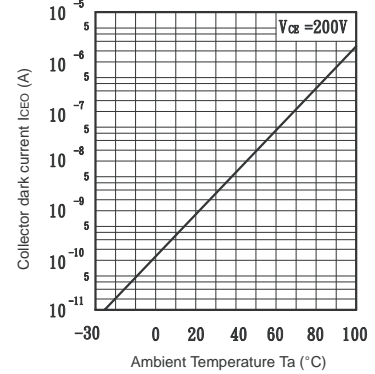

Fig.10 Response Time vs. Load Resistance

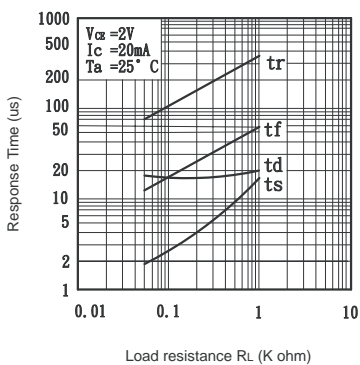

Fig.11 Frequency Response

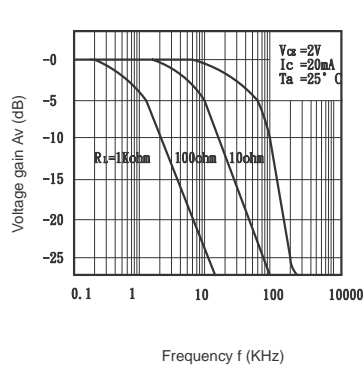

Fig.12 Collector-emitter Saturation Voltage vs. Forward current

