

IRG4BC30K-SPbF

Short Circuit Rated
UltraFast IGBT

INSULATED GATE BIPOLAR TRANSISTOR

Features

- High short circuit rating optimized for motor control, $t_{sc} = 10\mu s$, @360V V_{CE} (start), $T_J = 125^\circ C$, $V_{GE} = 15V$
- Combines low conduction losses with high switching speed
- Latest generation design provides tighter parameter distribution and higher efficiency than previous generations
- Lead-Free

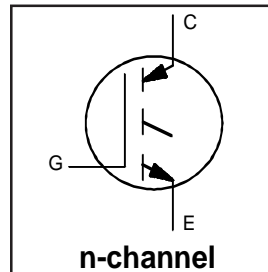

$V_{CES} = 600V$
$V_{CE(on)} \text{ typ.} = 2.21V$
@ $V_{GE} = 15V, I_C = 16A$

Benefits

- As a Freewheeling Diode we recommend our HEXFRED™ ultrafast, ultrasoft recovery diodes for minimum EMI / Noise and switching losses in the Diode and IGBT
- Latest generation 4 IGBTs offer highest power density motor controls possible
- This part replaces the IRGBC30K-S and IRGBC30M-S devices

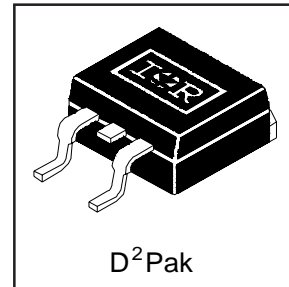

Absolute Maximum Ratings

	Parameter	Max.	Units
V_{CES}	Collector-to-Emitter Voltage	600	V
$I_C @ T_C = 25^\circ C$	Continuous Collector Current	28	A
$I_C @ T_C = 100^\circ C$	Continuous Collector Current	16	
I_{CM}	Pulsed Collector Current ①	58	
I_{LM}	Clamped Inductive Load Current ②	58	
t_{sc}	Short Circuit Withstand Time	10	μs
V_{GE}	Gate-to-Emitter Voltage	± 20	V
E_{ARV}	Reverse Voltage Avalanche Energy ③	260	mJ
$P_D @ T_C = 25^\circ C$	Maximum Power Dissipation	100	W
$P_D @ T_C = 100^\circ C$	Maximum Power Dissipation	42	
T_J	Operating Junction and Storage Temperature Range	-55 to +150	$^\circ C$
T_{STG}			
	Soldering Temperature, for 10 sec.	300 (0.063 in. (1.6mm) from case)	
	Mounting torque, 6-32 or M3 screw.	10 lbf·in (1.1N·m)	

Thermal Resistance

	Parameter	Typ.	Max.	Units
$R_{\theta JC}$	Junction-to-Case	---	1.2	$^\circ C/W$
$R_{\theta CS}$	Case-to-Sink, Flat, Greased Surface	0.5	---	
$R_{\theta JA}$	Junction-to-Ambient (PCB Mounted, steady-state) ④	---	40	
Wt	Weight	1.44	---	g

IRG4BC30K-SPbF

International
IRF Rectifier

Electrical Characteristics @ $T_J = 25^\circ\text{C}$ (unless otherwise specified)

	Parameter	Min.	Typ.	Max.	Units	Conditions	
$V_{(BR)CES}$	Collector-to-Emitter Breakdown Voltage	600	—	—	V	$V_{GE} = 0V, I_C = 250\mu A$	
$V_{(BR)ECS}$	Emitter-to-Collector Breakdown Voltage ④	18	—	—	V	$V_{GE} = 0V, I_C = 1.0A$	
$\Delta V_{(BR)CES}/\Delta T_J$	Temperature Coeff. of Breakdown Voltage	—	0.54	—	V/°C	$V_{GE} = 0V, I_C = 1.0mA$	
$V_{CE(ON)}$	Collector-to-Emitter Saturation Voltage	—	2.21	—	V	$V_{GE} = 15V$ See Fig.2, 5	
		—	2.21	2.7			$I_C = 14A$
		—	2.88	—			$I_C = 16A$
		—	2.36	—			$I_C = 28A$ $I_C = 16A, T_J = 150^\circ\text{C}$
$V_{GE(th)}$	Gate Threshold Voltage	3.0	—	6.0		$V_{CE} = V_{GE}, I_C = 250\mu A$	
$\Delta V_{GE(th)}/\Delta T_J$	Temperature Coeff. of Threshold Voltage	—	-12	—	mV/°C	$V_{CE} = V_{GE}, I_C = 250\mu A$	
g_{fe}	Forward Transconductance ⑤	5.4	8.1	—	S	$V_{CE} = 100V, I_C = 16A$	
I_{CES}	Zero Gate Voltage Collector Current	—	—	250	μA	$V_{GE} = 0V, V_{CE} = 600V$	
		—	—	2.0		$V_{GE} = 0V, V_{CE} = 10V, T_J = 25^\circ\text{C}$	
		—	—	1100		$V_{GE} = 0V, V_{CE} = 600V, T_J = 150^\circ\text{C}$	
I_{GES}	Gate-to-Emitter Leakage Current	—	—	± 100	nA	$V_{GE} = \pm 20V$	

Switching Characteristics @ $T_J = 25^\circ\text{C}$ (unless otherwise specified)

	Parameter	Min.	Typ.	Max.	Units	Conditions
Q_g	Total Gate Charge (turn-on)	—	67	100	nC	$I_C = 16A$ $V_{CC} = 400V$ $V_{GE} = 15V$ See Fig.8
Q_{ge}	Gate - Emitter Charge (turn-on)	—	11	16		
Q_{gc}	Gate - Collector Charge (turn-on)	—	25	37		
$t_{d(on)}$	Turn-On Delay Time	—	26	—	ns	$T_J = 25^\circ\text{C}$ $I_C = 16A, V_{CC} = 480V$ $V_{GE} = 15V, R_G = 23\Omega$ Energy losses include "tail"
t_r	Rise Time	—	28	—		
$t_{d(off)}$	Turn-Off Delay Time	—	130	200		
t_f	Fall Time	—	120	170		
E_{on}	Turn-On Switching Loss	—	0.36	—	mJ	See Fig. 9,10,14
E_{off}	Turn-Off Switching Loss	—	0.51	—		
E_{ts}	Total Switching Loss	—	0.87	1.3		
t_{sc}	Short Circuit Withstand Time	10	—	—	μs	$V_{CC} = 400V, T_J = 125^\circ\text{C}$ $V_{GE} = 15V, R_G = 23\Omega, V_{CPK} < 500V$
$t_{d(on)}$	Turn-On Delay Time	—	25	—	ns	$T_J = 150^\circ\text{C}$, $I_C = 16A, V_{CC} = 480V$ $V_{GE} = 15V, R_G = 23\Omega$ Energy losses include "tail"
t_r	Rise Time	—	29	—		
$t_{d(off)}$	Turn-Off Delay Time	—	190	—		
t_f	Fall Time	—	190	—		
E_{ts}	Total Switching Loss	—	1.2	—	mJ	See Fig. 11,14
E_{on}	Turn-On Switching Loss	—	0.26	—	mJ	$T_J = 25^\circ\text{C}, V_{GE} = 15V, R_G = 23\Omega$ $I_C = 14A, V_{CC} = 480V$ Energy losses include "tail"
E_{off}	Turn-Off Switching Loss	—	0.36	—		
E_{ts}	Total Switching Loss	—	0.62	—		
L_E	Internal Emitter Inductance	—	7.5	—	nH	Measured 5mm from package
C_{ies}	Input Capacitance	—	920	—	pF	$V_{GE} = 0V$ $V_{CC} = 30V$ $f = 1.0MHz$ See Fig. 7
C_{oes}	Output Capacitance	—	110	—		
C_{res}	Reverse Transfer Capacitance	—	27	—		

Details of note ① through ⑥ are on the last page

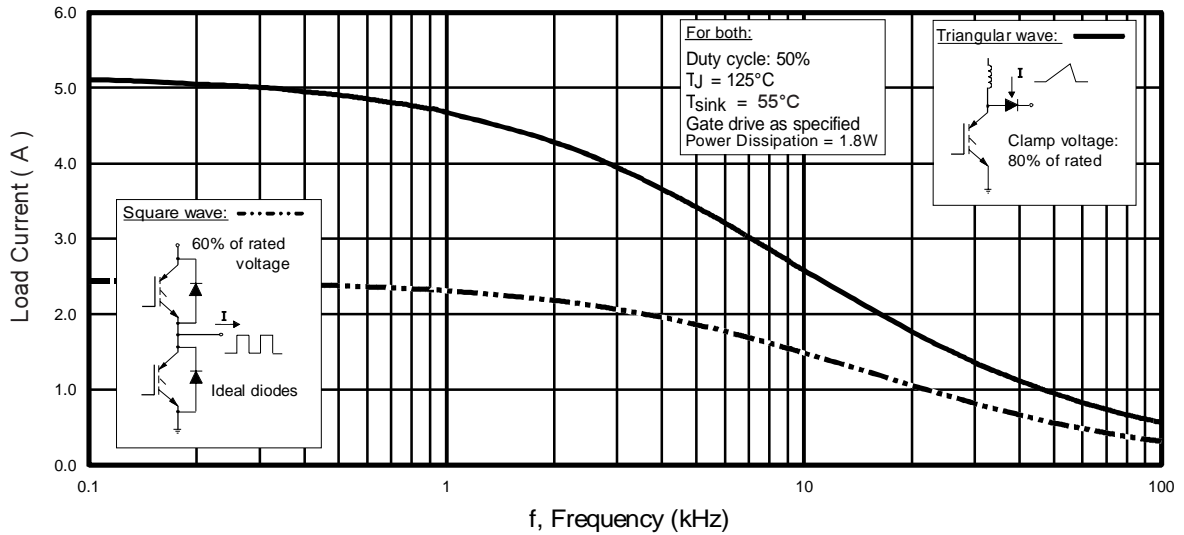

Fig. 1 - Typical Load Current vs. Frequency
(Load Current = I_{RMS} of fundamental)

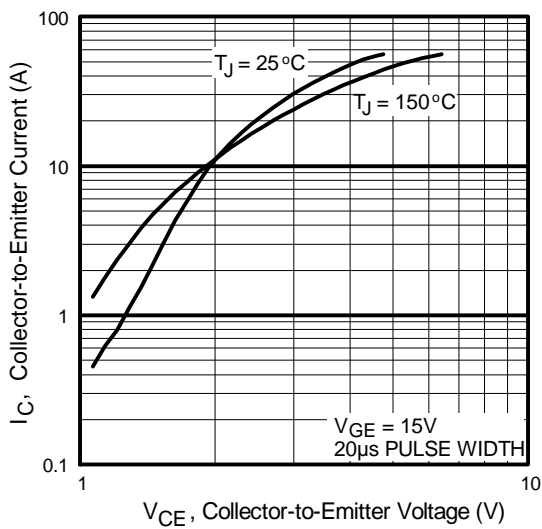

Fig. 2 - Typical Output Characteristics

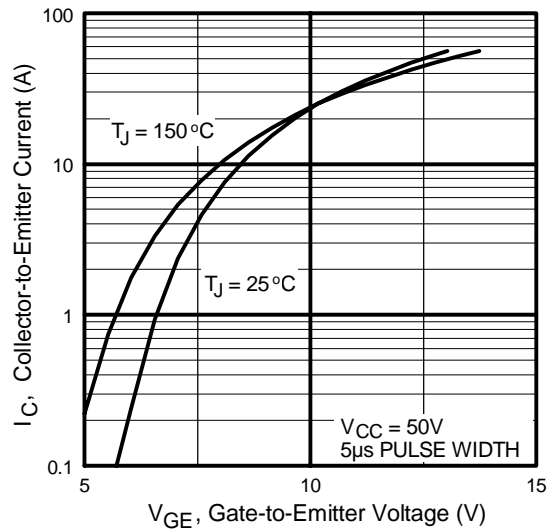

Fig. 3 - Typical Transfer Characteristics

IRG4BC30K-SPbF

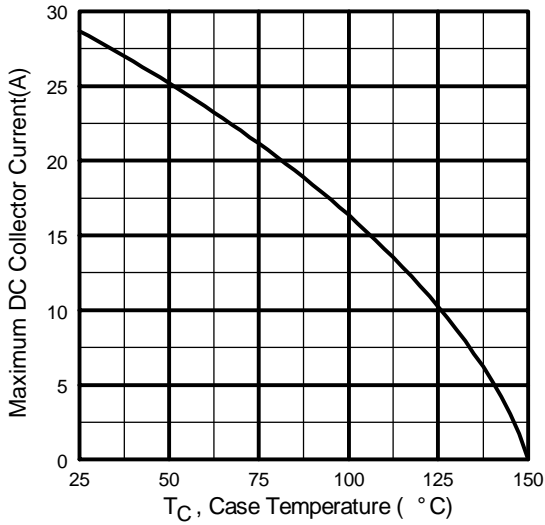

Fig. 4 - Maximum Collector Current vs. Case Temperature

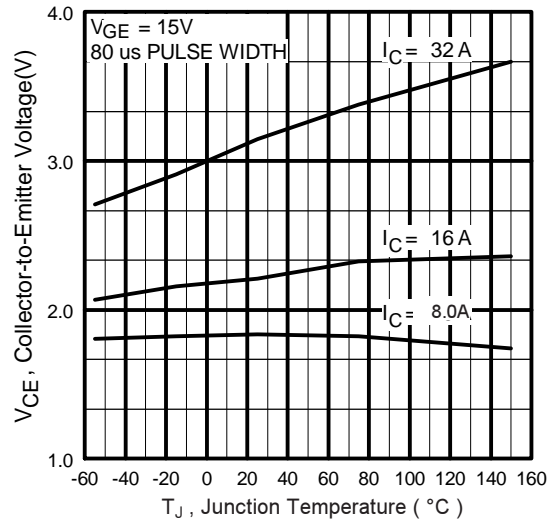

Fig. 5 - Typical Collector-to-Emitter Voltage vs. Junction Temperature

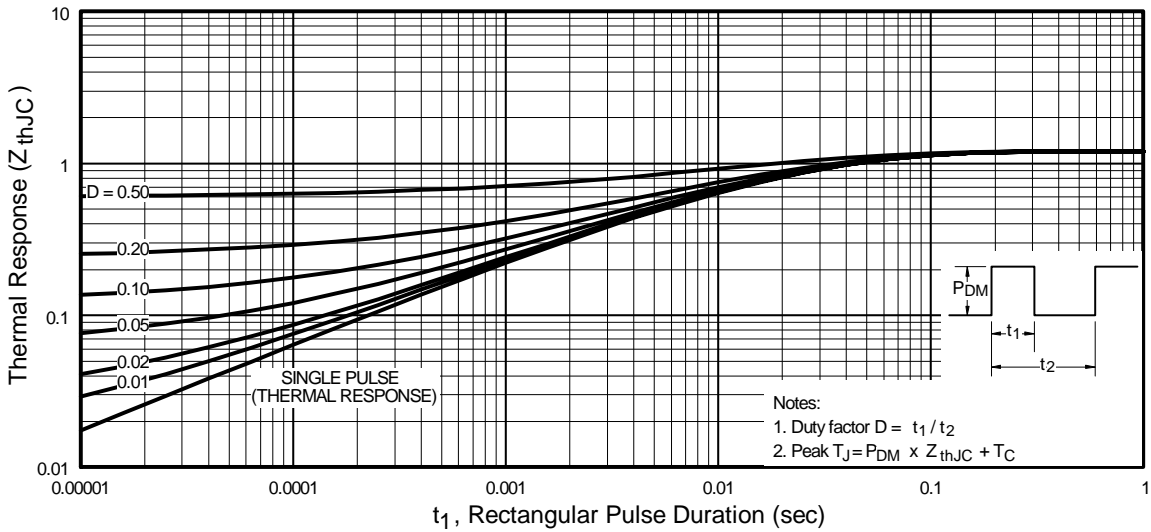

Fig. 6 - Maximum Effective Transient Thermal Impedance, Junction-to-Case

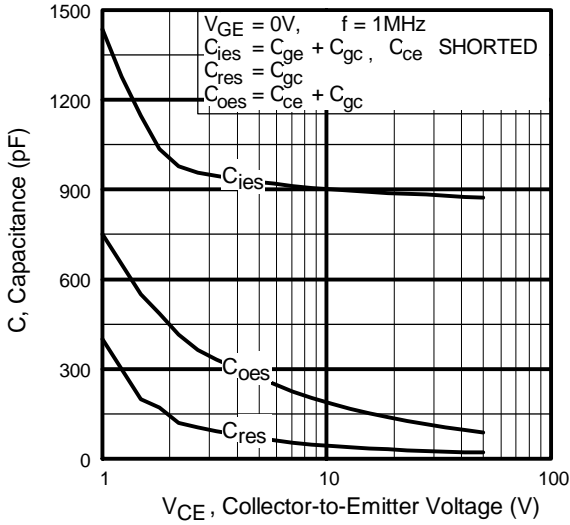

Fig. 7 - Typical Capacitance vs. Collector-to-Emitter Voltage

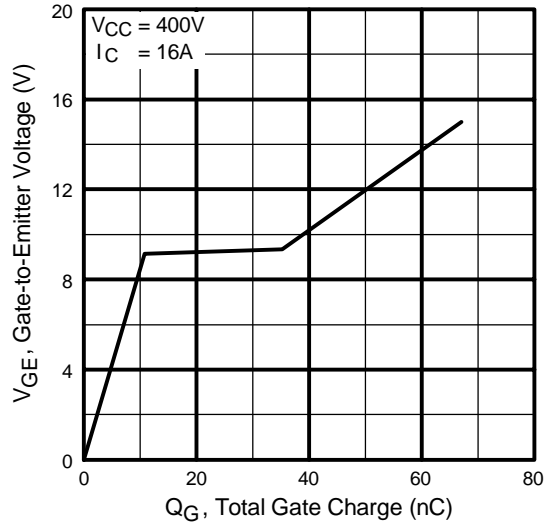

Fig. 8 - Typical Gate Charge vs. Gate-to-Emitter Voltage

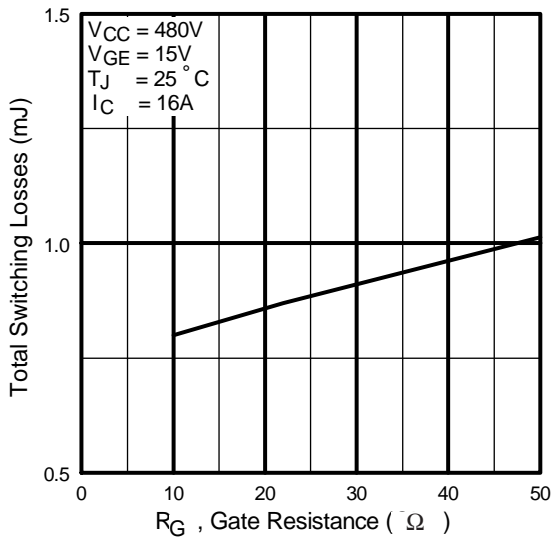

Fig. 9 - Typical Switching Losses vs. Gate Resistance

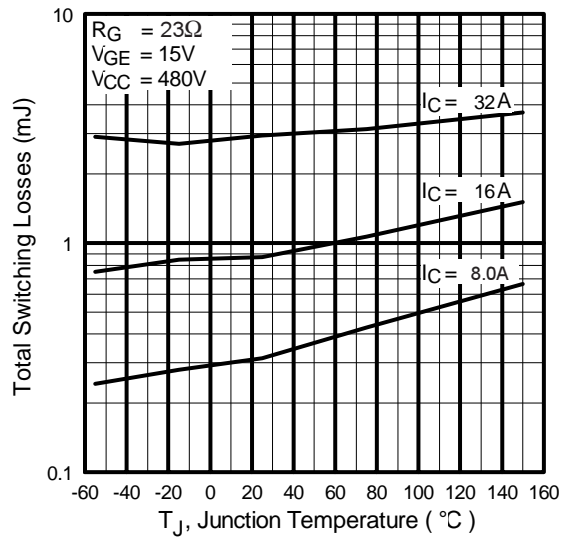

Fig. 10 - Typical Switching Losses vs. Junction Temperature

IRG4BC30K-SPbF

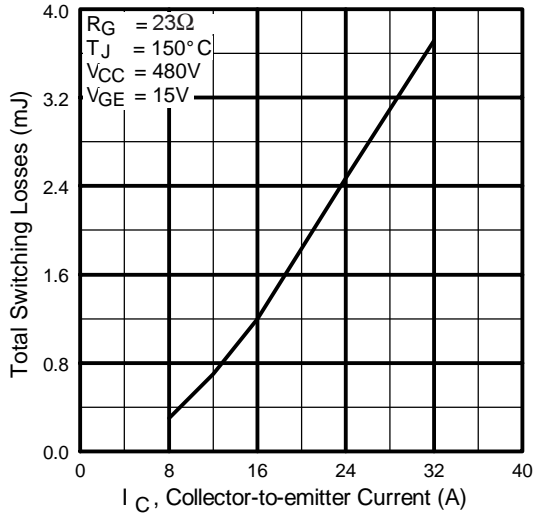

Fig. 11 - Typical Switching Losses vs. Collector-to-Emitter Current

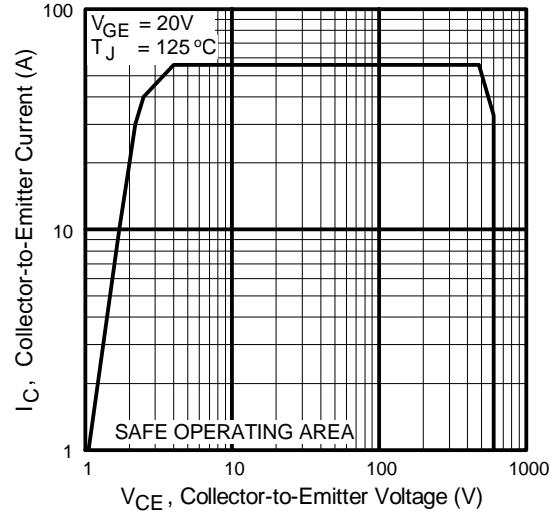

Fig. 12 - Turn-Off SOA

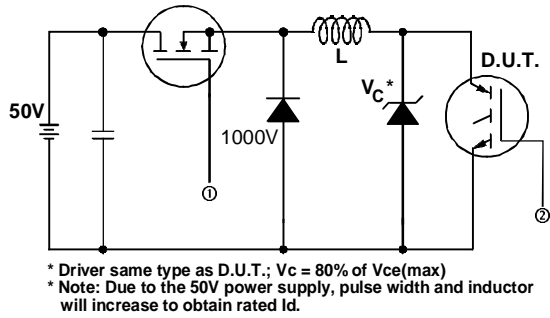

Fig. 13a - Clamped Inductive Load Test Circuit

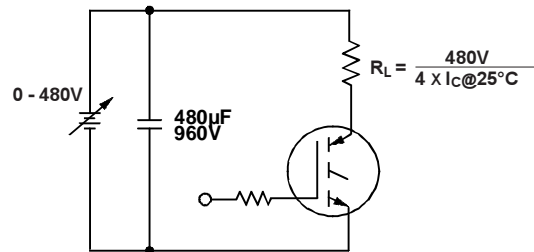

Fig. 13b - Pulsed Collector Current Test Circuit

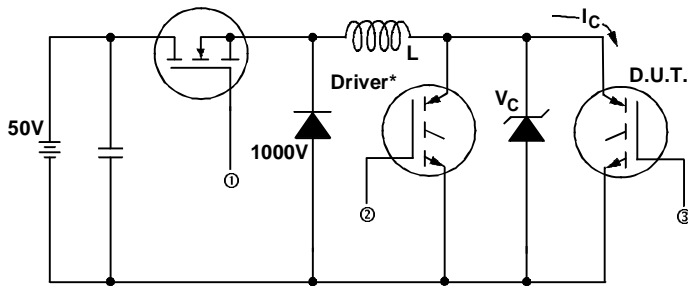

Fig. 14a - Switching Loss Test Circuit

* Driver same type as D.U.T., $V_C = 480V$

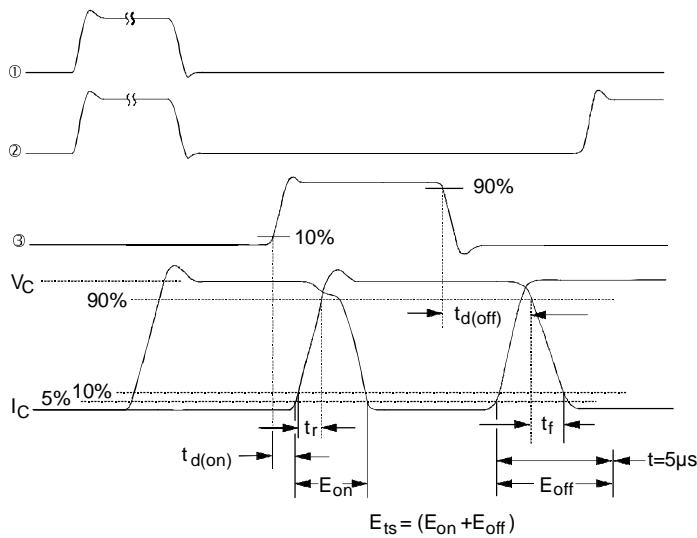

Fig. 14b - Switching Loss Waveforms

IRG4BC30K-SPbF



D²Pak Package Outline

Dimensions are shown in millimeters (inches)

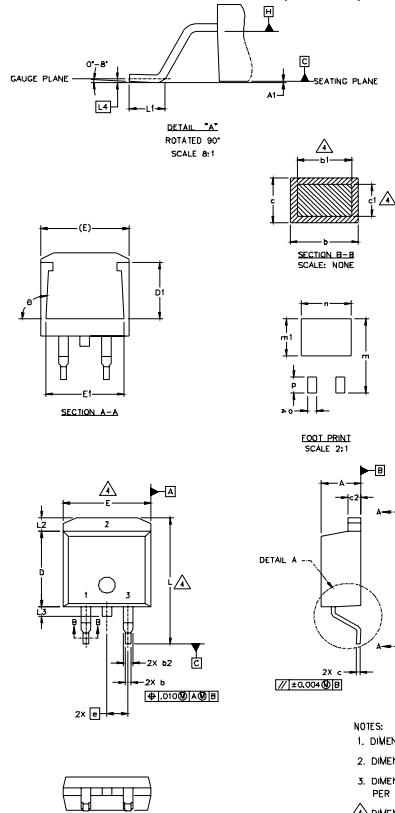

SYMBOL	DIMENSIONS				NOTES
	MILLIMETERS		INCHES		
	MIN.	MAX.	MIN.	MAX.	
A	4.06	4.83	.160	.190	4
A1		0.127		.005	
b	0.51	0.99	.020	.039	
b1	0.51	0.89	.020	.035	
b2	1.14	1.40	.045	.055	4
c	0.43	0.63	.017	.025	
c1	0.38	0.74	.015	.029	3
c2	1.14	1.40	.045	.055	
D	8.51	9.65	.335	.380	3
D1	5.33		.210		
E	9.65	10.67	.380	.420	3
E1	6.22		.245		
e	2.54 BSC		.100 BSC		
L	14.61	15.88	.575	.625	
L1	1.78	2.79	.070	.110	
L2		1.65		.065	
L3	1.27	1.78	.050	.070	
L4	0.25 BSC		.010 BSC		
m	17.78		.700		
m1	8.89		.350		
n	11.43		.450		
o	2.08		.082		
p	3.81		.150		
θ	90°	93°	90°	93°	

LEAD ASSIGNMENTS

HEXFET	IGBTs, CoPACK	DIODES
1- GATE	1- GATE	1- ANODE *
2- DRAIN	2- COLLECTOR	2- CATHODE
3- SOURCE	3- EMITTER	3- ANODE

* PART DEPENDENT.

NOTES:

- DIMENSIONING AND TOLERANCING PER ASME Y14.5M-1994
- DIMENSIONS ARE SHOWN IN MILLIMETERS (INCHES)
- DIMENSION D & E DO NOT INCLUDE MOLD FLASH. MOLD FLASH SHALL NOT EXCEED 0.127 [.005"] PER SIDE. THESE DIMENSIONS ARE MEASURED AT THE OUTMOST EXTREMES OF THE PLASTIC BODY.
- DIMENSION b1 AND c1 APPLY TO BASE METAL ONLY.
- CONTROLLING DIMENSION: INCH.

D²Pak Part Marking Information

EXAMPLE: THIS IS AN IRF530S WITH LOT CODE 8024 ASSEMBLED ON WW 02, 2000 IN THE ASSEMBLY LINE "L"

Note: "P" in assembly line position indicates "Lead-Free"

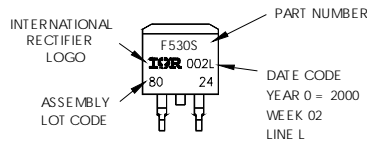

OR

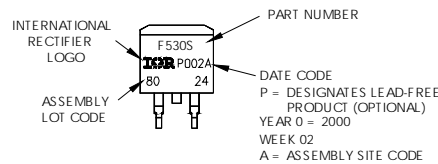

D²Pak Tape & Reel Information

Dimensions are shown in millimeters (inches)

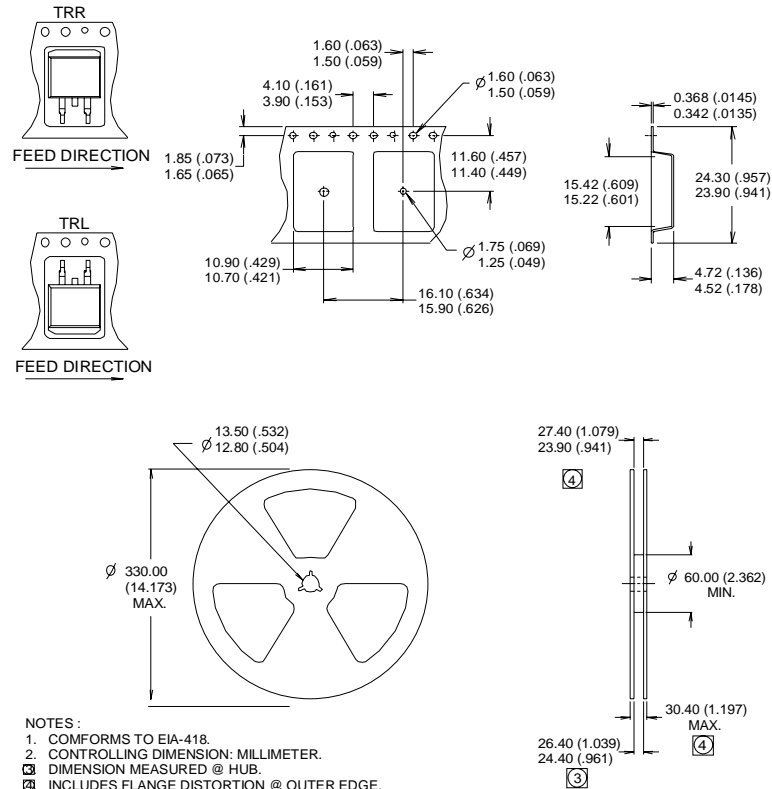

Notes:

- ① Repetitive rating; $V_{GE} = 20V$, pulse width limited by max. junction temperature. (See fig. 13b)
- ② $V_{CC} = 80\%(V_{CES})$, $V_{GE} = 20V$, $L = 10\mu H$, $R_G = 23\Omega$, (See fig. 13a)
- ③ Repetitive rating; pulse width limited by maximum junction temperature.
- ④ Pulse width $\leq 80\mu s$; duty factor $\leq 0.1\%$.
- ⑤ Pulse width $5.0\mu s$, single shot.
- ⑥ When mounted on 1" square PCB (FR-4 or G-10 Material). For recommended footprint and soldering techniques refer to application note #AN-994.

Data and specifications subject to change without notice.

International
IR Rectifier

IR WORLD HEADQUARTERS: 233 Kansas St., El Segundo, California 90245, USA Tel: (310) 252-7105
TAC Fax: (310) 252-7903

Visit us at www.irf.com for sales contact information. 08/04