



Integrated  
Circuit  
Systems, Inc.

# PRELIMINARY

# ICS844051I FEMTOCLOCKS™ CRYSTAL-TO- LVDS CLOCK GENERATOR

## GENERAL DESCRIPTION



The ICS844051I is a Gigabit Ethernet Clock Generator and a member of the HiPerClocks™ family of high performance devices from ICS. The ICS844051I can synthesize 10 Gigabit Ethernet, SONET, or Serial ATA reference clock frequencies with the appropriate choice of crystal and output divider. The ICS844051I has excellent phase jitter performance and is packaged in a small 8-pin TSSOP, making it ideal for use in systems with limited board space.

## FEATURES

- One Differential LVDS output
- Crystal oscillator interface designed for 18pF parallel resonant crystals (18.125MHz - 23.4375MHz)
- Output frequency range: 145MHz - 187.5MHz and 72.5MHz - 93.75MHz
- VCO range: 580MHz - 750MHz
- RMS phase jitter @156.25MHz (1.875MHz - 20MHz): 0.45ps (typical)
- 3.3V or 2.5V operating supply
- -40°C to 85°C ambient operating temperature
- Available in both standard and lead-free RoHS-compliant packages

## FREQUENCY TABLE

| Inputs                  |          | Output Frequency (MHz) |
|-------------------------|----------|------------------------|
| Crystal Frequency (MHz) | FREQ_SEL |                        |
| 20.141601               | 0        | 161.132812             |
| 20.141601               | 1        | 80.566406              |
| 19.53125                | 0        | 156.25                 |
| 19.53125                | 1        | 78.125                 |
| 19.44                   | 0        | 155.52                 |
| 19.44                   | 1        | 77.76                  |
| 18.75                   | 0        | 150                    |
| 18.75                   | 1        | 75                     |

## BLOCK DIAGRAM

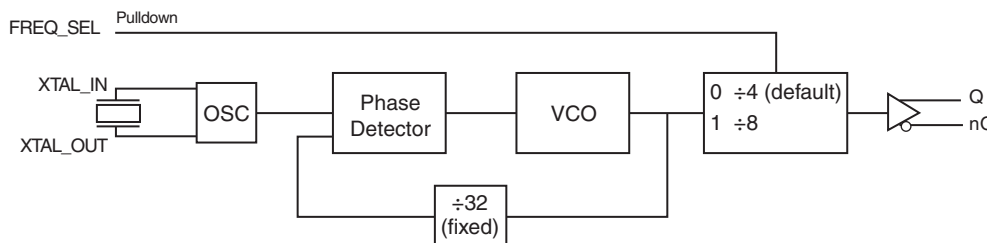

## PIN ASSIGNMENT

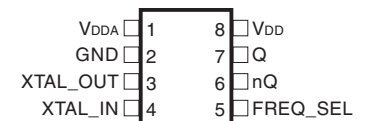

### ICS844051I

#### 8-Lead TSSOP

4.40mm x 3.0mm x 0.925mm

package body

**G Package**

Top View

The Preliminary Information presented herein represents a product in prototyping or pre-production. The noted characteristics are based on initial product characterization. Integrated Circuit Systems, Incorporated (ICS) reserves the right to change any circuitry or specifications without notice.



Integrated  
Circuit  
Systems, Inc.

# PRELIMINARY

# ICS844051I FEMTOCLOCKS™ CRYSTAL-TO- LVDS CLOCK GENERATOR

**TABLE 1. PIN DESCRIPTIONS**

| Number | Name                 | Type   |        | Description   |
|--------|----------------------|--------|--------|---|
| 1      | V <sub>DDA</sub>     | Power  |        | Analog supply pin.  |
| 2      | GND                  | Power  |        | Power supply ground.  |
| 3, 4   | XTAL_OUT,<br>XTAL_IN | Input  |        | Crystal oscillator interface. XTAL_IN is the input, XTAL_OUT is the output. |
| 5      | FREQ_SEL             | Input  | Pullup | Frequency select pin.   |
| 6, 7   | nQ, Q                | Output |        | Differential clock outputs. LVDS interface levels.                          |
| 8      | V <sub>DD</sub>      | Power  |        | Power supply pin.   |

NOTE: *Pullup* refers to internal input resistors. See Table 2, Pin Characteristics, for typical values.

**TABLE 2. PIN CHARACTERISTICS**

| Symbol              | Parameter             | Test Conditions | Minimum | Typical | Maximum | Units |
|---------------------|-----------------------|-----------------|---------|---------|---------|-------|
| C <sub>IN</sub>     | Input Capacitance     |                 |         | 4       |         | pF    |
| R <sub>PULLUP</sub> | Input Pullup Resistor |                 |         | 51      |         | kΩ    |



### ABSOLUTE MAXIMUM RATINGS

|  |                           |
|--|---------------------------|
| Supply Voltage, $V_{DD}$                 | 4.6V                      |
| Inputs, $V_i$                            | -0.5V to $V_{DD} + 0.5 V$ |
| Outputs, $I_o$ (LVDS)                    |                           |
| Continuous Current                       | 10mA                      |
| Surge Current                            | 15mA                      |
| Package Thermal Impedance, $\theta_{JA}$ | 101.7°C/W (0 mps)         |
| Storage Temperature, $T_{STG}$           | -65°C to 150°C            |

NOTE: Stresses beyond those listed under Absolute Maximum Ratings may cause permanent damage to the device. These ratings are stress specifications only. Functional operation of product at these conditions or any conditions beyond those listed in the *DC Characteristics* or *AC Characteristics* is not implied. Exposure to absolute maximum rating conditions for extended periods may affect product reliability.

**TABLE 3A. POWER SUPPLY DC CHARACTERISTICS,  $V_{DD} = V_{DDA} = 3.3V \pm 5\%$ ,  $T_A = -40^\circ C$  TO  $85^\circ C$**

| Symbol    | Parameter             | Test Conditions | Minimum | Typical | Maximum | Units |
|-----------|-----------------------|-----------------|---------|---------|---------|-------|
| $V_{DD}$  | Power Supply Voltage  |                 | 3.135   | 3.3     | 3.465   | V     |
| $V_{DDA}$ | Analog Supply Voltage |                 | 3.135   | 3.3     | 3.465   | V     |
| $I_{DD}$  | Power Supply Current  |                 |         | 100     |         | mA    |
| $I_{DDA}$ | Analog Supply Current |                 |         | 8       |         | mA    |

**TABLE 3B. POWER SUPPLY DC CHARACTERISTICS,  $V_{DD} = V_{DDA} = 2.5V \pm 5\%$ ,  $T_A = -40^\circ C$  TO  $85^\circ C$**

| Symbol    | Parameter             | Test Conditions | Minimum | Typical | Maximum | Units |
|-----------|-----------------------|-----------------|---------|---------|---------|-------|
| $V_{DD}$  | Power Supply Voltage  |                 | 2.375   | 2.5     | 2.625   | V     |
| $V_{DDA}$ | Analog Supply Voltage |                 | 2.375   | 2.5     | 2.625   | V     |
| $I_{DD}$  | Power Supply Current  |                 |         | 95      |         | mA    |
| $I_{DDA}$ | Analog Supply Current |                 |         | 8       |         | mA    |

**TABLE 3C. LVCMOS/LVTTL DC CHARACTERISTICS,  $V_{DD} = V_{DDA} = 3.3V \pm 5\%$  OR  $2.5V \pm 5\%$ ,  $T_A = -40^\circ C$  TO  $85^\circ C$**

| Symbol   | Parameter          | Test Conditions                               | Minimum | Typical | Maximum        | Units   |
|----------|--------------------|---|---------|---------|----------------|---------|
| $V_{IH}$ | Input High Voltage | $V_{DD} = 3.3V$                               | 2       |         | $V_{DD} + 0.3$ | V       |
|          |                    | $V_{DD} = 2.5$                                | 1.7     |         | $V_{DD} + 0.3$ | V       |
| $V_{IL}$ | Input Low Voltage  | $V_{DD} = 3.3V$                               | -0.3    |         | 0.8            | V       |
|          |                    | $V_{DD} = 2.5$                                | -0.3    |         | 0.7            | V       |
| $I_{IH}$ | Input High Current | $V_{DD} = V_{IN} = 3.465V$ or $2.625V$        |         |         | 5              | $\mu A$ |
| $I_{IL}$ | Input Low Current  | $V_{DD} = 3.465V$ or $2.625V$ , $V_{IN} = 0V$ | -150    |         |                | $\mu A$ |



Integrated  
Circuit  
Systems, Inc.

**PRELIMINARY**

**ICS844051I**  
FEMTOCLOCKS™ CRYSTAL-TO- LVDS  
CLOCK GENERATOR

**TABLE 3D. LVDS DC CHARACTERISTICS,  $V_{DD} = V_{DDA} = 3.3V \pm 5\%$ ,  $T_A = -40^\circ C$  TO  $85^\circ C$**

| Symbol          | Parameter                   | Test Conditions | Minimum | Typical | Maximum | Units |
|-----------------|-----------------------------|-----------------|---------|---------|---------|-------|
| $V_{OD}$        | Differential Output Voltage |                 |         | 350     |         | mV    |
| $\Delta V_{OD}$ | $V_{OD}$ Magnitude Change   |                 |         | 400     |         | mV    |
| $V_{OS}$        | Offset Voltage              |                 |         | 1.4     |         | V     |
| $\Delta V_{OS}$ | $V_{OS}$ Magnitude Change   |                 |         | 50      |         | mV    |

**TABLE 3E. LVDS DC CHARACTERISTICS,  $V_{DD} = V_{DDA} = 2.5V \pm 5\%$ ,  $T_A = -40^\circ C$  TO  $85^\circ C$**

| Symbol          | Parameter                   | Test Conditions | Minimum | Typical | Maximum | Units |
|-----------------|-----------------------------|-----------------|---------|---------|---------|-------|
| $V_{OD}$        | Differential Output Voltage |                 |         | 350     |         | mV    |
| $\Delta V_{OD}$ | $V_{OD}$ Magnitude Change   |                 |         | 400     |         | mV    |
| $V_{OS}$        | Offset Voltage              |                 |         | 1.15    |         | V     |
| $\Delta V_{OS}$ | $V_{OS}$ Magnitude Change   |                 |         | 40      |         | mV    |

**TABLE 4. CRYSTAL CHARACTERISTICS**

| Parameter                          | Test Conditions | Minimum     | Typical | Maximum | Units    |
|------------------------------------|-----------------|-------------|---------|---------|----------|
| Mode of Oscillation                |                 | Fundamental |         |         |          |
| Frequency                          |                 | 18.125      |         | 23.4375 | MHz      |
| Equivalent Series Resistance (ESR) |                 |             |         | 50      | $\Omega$ |
| Shunt Capacitance                  |                 |             |         | 7       | pF       |
| Drive Level                        |                 |             |         | 1       | mW       |

**TABLE 5A. AC CHARACTERISTICS,  $V_{DD} = V_{DDA} = 3.3V \pm 5\%$ ,  $T_A = -40^\circ C$  TO  $85^\circ C$**

| Symbol               | Parameter                             | Test Conditions                                    | Minimum | Typical | Maximum | Units |
|----------------------|---------------------------------------|--|---------|---------|---------|-------|
| $f_{OUT}$            | Output Frequency                      |  |         | 156.25  |         | MHz   |
| $t_{jit}(\emptyset)$ | RMS Phase Jitter ( Random);<br>NOTE 1 | 156.25MHz @ Integration Range:<br>1.875MHz - 20MHz |         | 0.45    |         | ps    |
| $t_R / t_F$          | Output Rise/Fall Time                 | 20% to 80%   |         | 300     |         | ps    |
| odc                  | Output Duty Cycle                     |  |         | 50      |         | %     |

NOTE 1: Please refer to the Phase Noise Plots following this section.

**TABLE 5B. AC CHARACTERISTICS,  $V_{DD} = V_{DDA} = 2.5V \pm 5\%$ ,  $T_A = -40^\circ C$  TO  $85^\circ C$**

| Symbol               | Parameter                             | Test Conditions                                    | Minimum | Typical | Maximum | Units |
|----------------------|---------------------------------------|--|---------|---------|---------|-------|
| $f_{OUT}$            | Output Frequency                      |  |         | 156.25  |         | MHz   |
| $t_{jit}(\emptyset)$ | RMS Phase Jitter ( Random);<br>NOTE 1 | 156.25MHz @ Integration Range:<br>1.875MHz - 20MHz |         | 0.45    |         | ps    |
| $t_R / t_F$          | Output Rise/Fall Time                 | 20% to 80%   |         | 300     |         | ps    |
| odc                  | Output Duty Cycle                     |  |         | 50      |         | %     |

NOTE 1: Please refer to the Phase Noise Plots following this section.



## TYPICAL PHASE NOISE AT 156.25MHz @ 3.3V

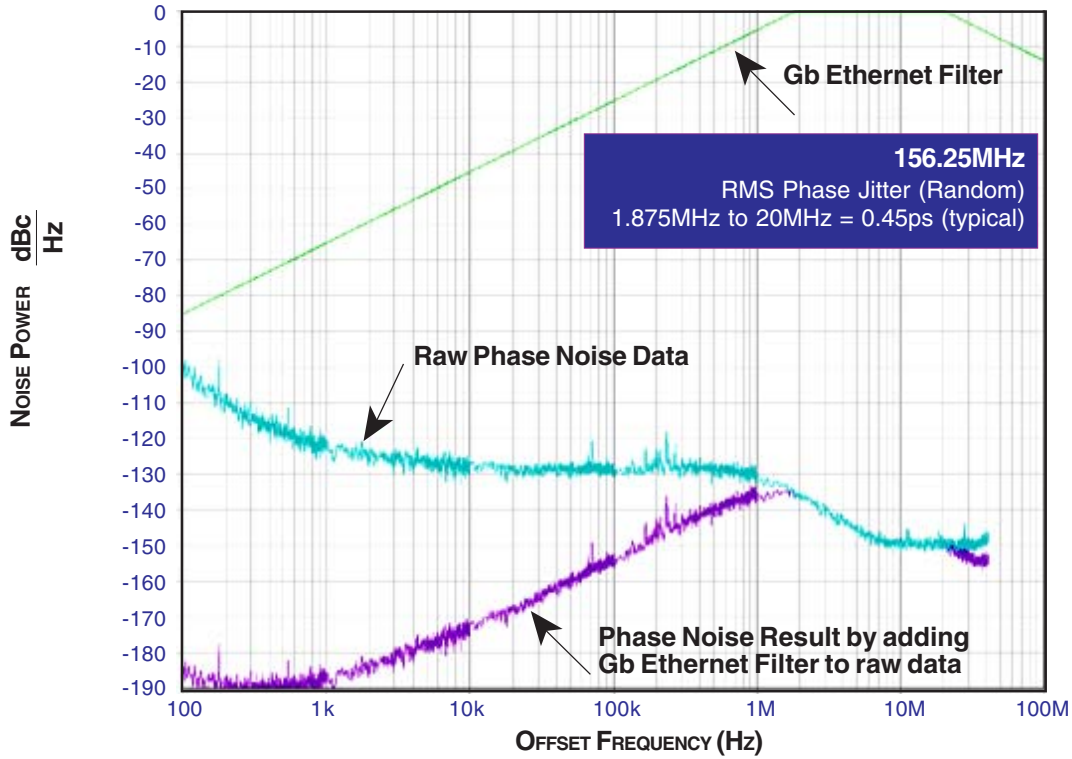

## TYPICAL PHASE NOISE AT 156.25MHz @ 2.5V

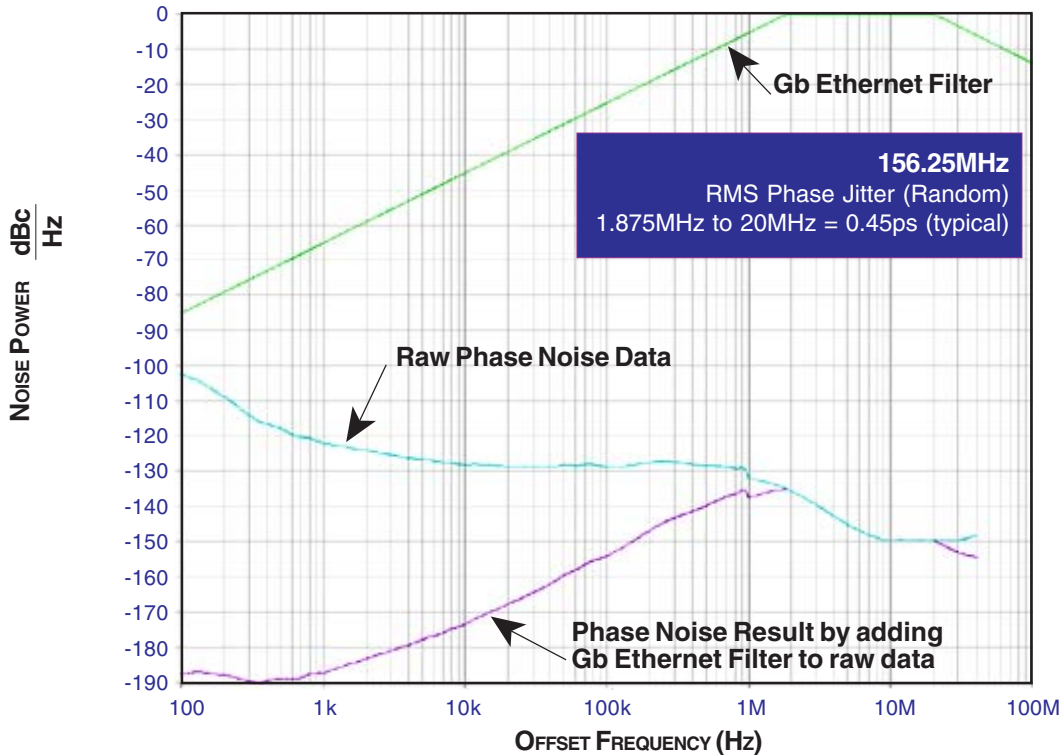



**PARAMETER MEASUREMENT INFORMATION**

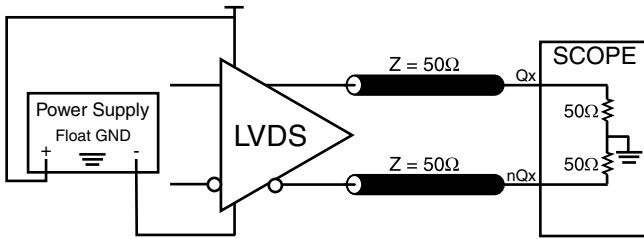

**LVDS 3.3V OUTPUT LOAD AC TEST CIRCUIT**

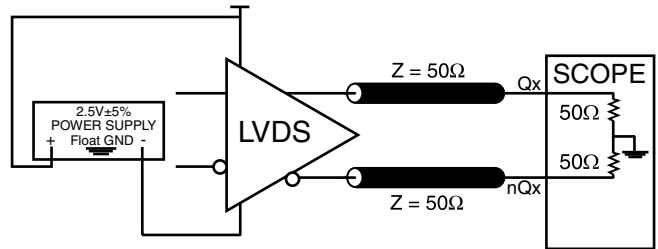

**LVDS 2.5V OUTPUT LOAD AC TEST CIRCUIT**

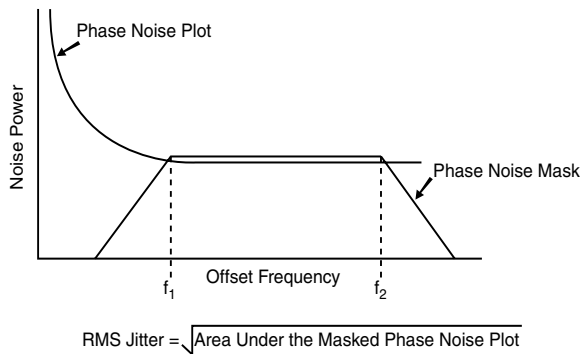

**RMS PHASE JITTER**

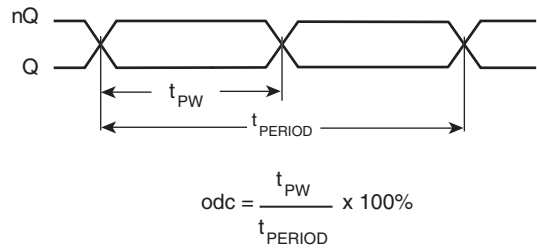

**OUTPUT DUTY CYCLE/PULSE WIDTH/PERIOD**

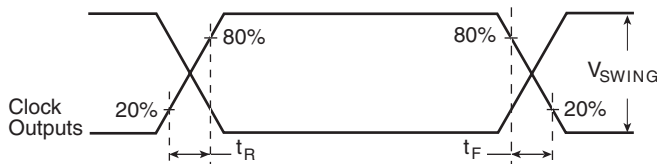

**OUTPUT RISE/FALL TIME**

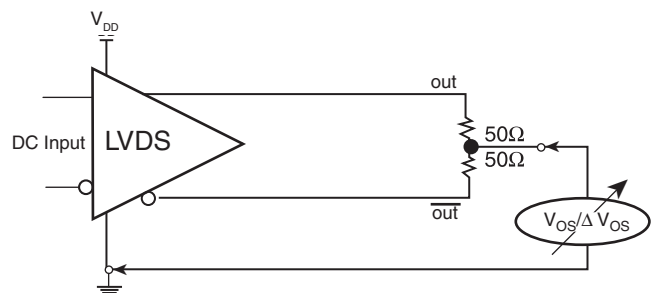

**OFFSET VOLTAGE SETUP**

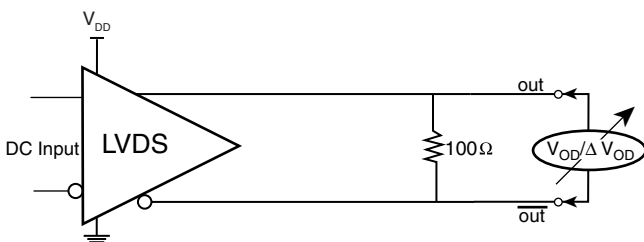

**DIFFERENTIAL OUTPUT VOLTAGE SETUP**



## APPLICATION INFORMATION

### POWER SUPPLY FILTERING TECHNIQUES

As in any high speed analog circuitry, the power supply pins are vulnerable to random noise. The ICS844051I provides separate power supplies to isolate any high switching noise from the outputs to the internal PLL.  $V_{DD}$  and  $V_{DDA}$  should be individually connected to the power supply plane through vias, and bypass capacitors should be used for each pin. To achieve optimum jitter performance, power supply isolation is required. *Figure 1* illustrates how a  $10\Omega$  resistor along with a  $10\mu\text{F}$  and a  $.01\mu\text{F}$  bypass capacitor should be connected to each  $V_{DDA}$  pin. The  $10\Omega$  resistor can also be replaced by a ferrite bead.

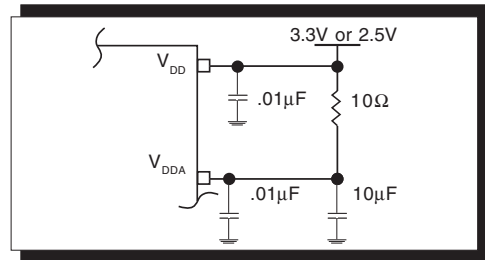
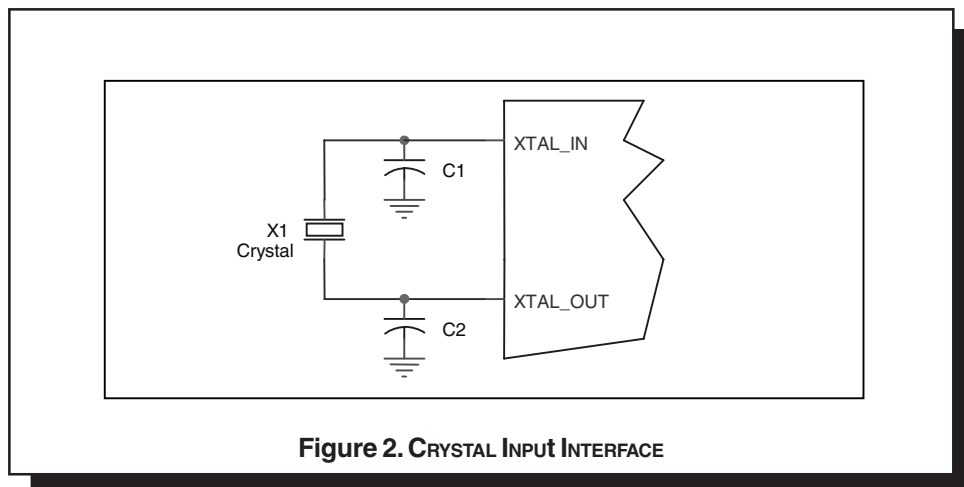

**FIGURE 1. POWER SUPPLY FILTERING**

### CRYSTAL INPUT INTERFACE

The ICS844051I has been characterized with 18pF parallel resonant crystals. The capacitor values, C1 and C2, shown in *Figure 2* below were determined using a 25MHz, 18pF parallel

resonant crystal and were chosen to minimize the ppm error. The optimum C1 and C2 values can be slightly adjusted for different board layouts.



**Figure 2. CRYSTAL INPUT INTERFACE**



### 3.3V, 2.5V LVDS DRIVER TERMINATION

A general LVDS interface is shown in *Figure 3*. In a 100Ω differential transmission line environment, LVDS drivers require a matched load termination of 100Ω across near

the receiver input. For a multiple LVDS outputs buffer, if only partial outputs are used, it is recommended to terminate the un-used outputs.

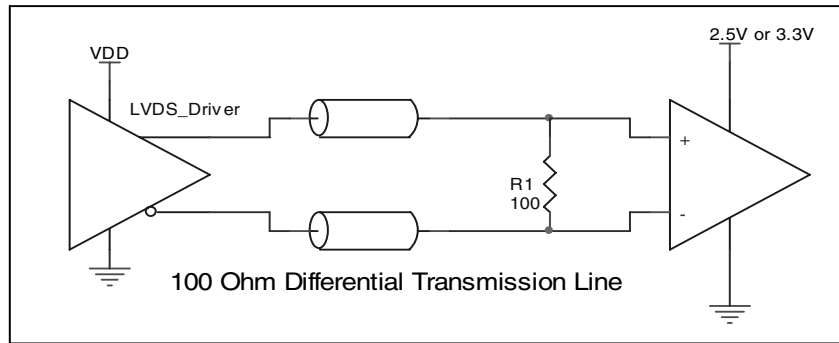

**FIGURE 3. TYPICAL LVDS DRIVER TERMINATION**





Integrated  
Circuit  
Systems, Inc.

# PRELIMINARY

**ICS844051I**  
FEMTOCLOCKS™ CRYSTAL-TO- LVDS  
CLOCK GENERATOR

## RELIABILITY INFORMATION

TABLE 6.  $\theta_{JA}$  vs. AIR FLOW TABLE FOR 8 LEAD TSSOP

| $\theta_{JA}$ by Velocity (Meters per Second) |           |          |          |
|---|-----------|----------|----------|
|   | 0         | 1        | 2.5      |
| Multi-Layer PCB, JEDEC Standard Test Boards   | 101.7°C/W | 90.5°C/W | 89.8°C/W |

### TRANSISTOR COUNT

The transistor count for ICS844051I is: 2395



PACKAGE OUTLINE - G SUFFIX FOR 8 LEAD TSSOP

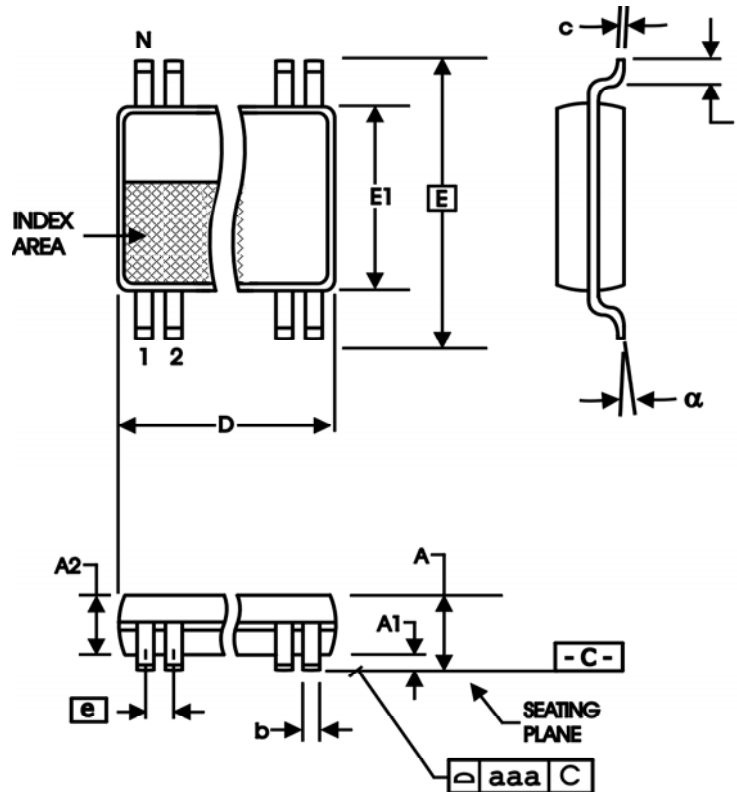

TABLE 7. PACKAGE DIMENSIONS

| SYMBOL | Millimeters |         |
|--------|-------------|---------|
|        | Minimum     | Maximum |
| N      | 8           |         |
| A      | --          | 1.20    |
| A1     | 0.05        | 0.15    |
| A2     | 0.80        | 1.05    |
| b      | 0.19        | 0.30    |
| c      | 0.09        | 0.20    |
| D      | 2.90        | 3.10    |
| E      | 6.40 BASIC  |         |
| E1     | 4.30        | 4.50    |
| e      | 0.65 BASIC  |         |
| L      | 0.45        | 0.75    |
| alpha  | 0°          | 8°      |
| aaa    | --          | 0.10    |

Reference Document: JEDEC Publication 95, MO-153



Integrated  
Circuit  
Systems, Inc.

# PRELIMINARY

## ICS844051I FEMTOCLOCKS™ CRYSTAL-TO- LVDS CLOCK GENERATOR

**TABLE 8. ORDERING INFORMATION**

| Part/Order Number | Marking | Package                  | Shipping Packaging | Temperature   |
|-------------------|---------|--------------------------|--------------------|---------------|
| ICS844051CGI      | 451CI   | 8 Lead TSSOP             | tube               | -40°C to 85°C |
| ICS844051CGIT     | 451CI   | 8 Lead TSSOP             | 2500 tape & reel   | -40°C to 85°C |
| ICS844051CGILF    | TBD     | 8 Lead "Lead-Free" TSSOP | tube               | -40°C to 85°C |
| ICS844051CGILFT   | TBD     | 8 Lead "Lead-Free" TSSOP | 2500 tape & reel   | -40°C to 85°C |

NOTE: Parts that are ordered with an "LF" suffix to the part number are the Pb-Free configuration and are RoHS compliant.

The aforementioned trademarks, HiPerClockS and FemtoClocks are trademarks of Integrated Circuit Systems, Inc. or its subsidiaries in the United States and/or other countries. While the information presented herein has been checked for both accuracy and reliability, Integrated Circuit Systems, Incorporated (ICS) assumes no responsibility for either its use or for infringement of any patents or other rights of third parties, which would result from its use. No other circuits, patents, or licenses are implied. This product is intended for use in normal commercial and industrial applications. Any other applications such as those requiring high reliability or other extraordinary environmental requirements are not recommended without additional processing by ICS. ICS reserves the right to change any circuitry or specifications without notice. ICS does not authorize or warrant any ICS product for use in life support devices or critical medical instruments.