

15.5 dB, DC-4GHz, 5 Bit Parallel Digital Attenuator

Features

- Very Low DC Power Consumption
- Attenuation In Steps From 0.5 dB To 15.5 dB
- Single Or Dual Power Supply Voltages
- Parallel Data Interface
- 50 Ohm Compatible Impedance
- Space Saving VQFN Surface Mount Packaging

Product Description

The Honeywell HRF-AT4510 is a 5-bit digital attenuator that is ideal for use in broadband communication system applications that require accuracy, speed and low power consumption. The HRF-AT4510 is manufactured with Honeywell's patented Silicon On Insulator (SOI) CMOS manufacturing technology, which provides the performance of GaAs with the economy and integration capabilities of conventional CMOS.

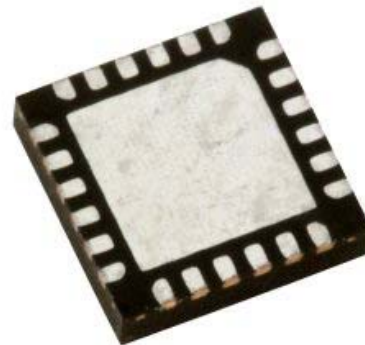

HRF-AT4510 in VQFN Package

RF Electrical Specifications @ + 25°C

Results @ Vdd = 5.0 +/- 10%, Vss = 0 unless otherwise stated, Z0 = 50 Ohms
Contact Honeywell for relative performance at other supply configurations

Parameter	Test Condition	Frequency	Minimum	Typical	Maximum	Units
Insertion Loss		DC - 0.5 GHz		1.60	2.20	dB
		2.0 GHz		2.00	2.40	dB
		3.0 GHz		2.40	2.90	dB
		4.0 GHz		4.40	5.00	dB
1dB Compression	VSS = 0V, Input Power	1.0 GHz		22.5		dBm
		2.0 GHz		21.0		dBm
1dB Compression	VSS = -3, Input Power	1.0 GHz		28.5		dBm
		2.0 GHz		27.0		dBm
Input IP3	VSS = 0V Two-tone inputs Up To +5 dBm @ 0 dB Attenuation	2.0 GHz		36.0		dBm
Input IP3	Vss = -3 Two-tone inputs Up To +5 dBm @ 0 dB Attenuation	2.0 GHz		>36.0		dBm
Return Loss*	Any Bit or Combination of Bits	DC - 4.0 GHz	-11	-15		dB
Attenuation Accuracy	All attenuation states	DC - 1.0 GHz		+/- (0.17 + 3% of programmed IL)		dB
		2.0 GHz		+/- (0.22 + 3% of programmed IL)		dB
		3.0 GHz		+/- (0.33 + 3% of programmed IL)		dB
		4.0 GHz		+/- (0.45 + 3% of programmed IL)		dB
Trise, Tfall*	10% To 90%			10		nS
Ton, Toff (Tpd)	50% Cntl To 90%/10%RF			15		nS
Transients	In-Band			30		mV

0.01uF Decoupling Capacitors Required On Power Supply Rails.

*Rv design

Functional Schematic

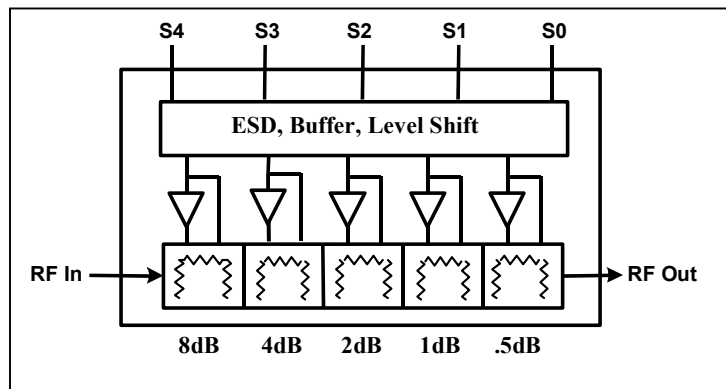

DC Electrical Specifications @ + 25°C

Parameter	Minimum	Typical	Maximum	Units
V _{DD}	3.3 ¹	5.0	5.5	V
V _{SS}			-5.0	V
I _{DD} Power Supply Current			35	uA
CMOS Logic level (0)	0		0.8	V
CMOS Logic level (1)	V _{DD} - 0.8		V _{DD}	V
Input Leakage Current			10	uA

Note 1, performance curves are for V_{DD}= +5.0 +/- 10%

Absolute Maximum Ratings²

Parameter	Absolute Maximum	Units
Input Power	+ 35	dBm
V _{DD}	+6.0	V
V _{SS}	-5.5	V
ESD Voltage	400	V
Operating Temperature	-40 To +85	Degrees C
Storage Temperature	-65 To +125	Degrees C
Digital Inputs	V _{DD} +0.6 max to -0.6 min	V

(Note 2) Operation of this Device beyond any of these parameters may cause permanent damage.

Latch-Up: Unlike conventional CMOS digital attenuators, Honeywell's HRF-AT4510 is immune to latch-up.

ESD Protection: Although the HRF-AT4510 contains ESD protection circuitry on all digital inputs, conventional precautions should be taken to ensure that the Absolute Maximum Ratings are not exceeded.

Package Outline Drawing

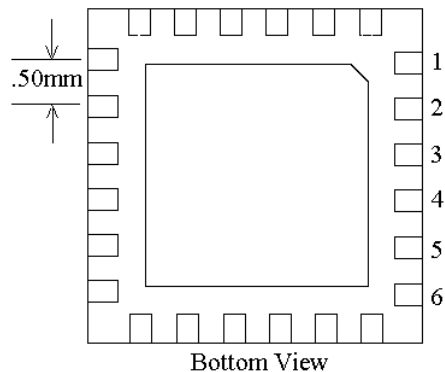

This package conforms to the LPCC™ 4 x 4 mm 24 lead body dimensions. See ASAT LPCC Marketing Outline Dwg. # DGMJ00004 Latest Rev. at <http://www.asat.com> for additional dimensional information. See Application Note 310, VQFN Surface Mount Application, on our web site at <http://www.mysoiservices.com/> for assembly recommendations.

Pin Configuration

Pin	Function	Pin	Function
1	VDD	13	GROUND
2	GROUND	14	GROUND
3	GROUND	15	RF OUTPUT
4	RF INPUT	16	GROUND
5	GROUND	17	VSS
6	GROUND	18	GROUND
7	GROUND	19	S0
8	GROUND	20	S1
9	GROUND	21	S2
10	GROUND	22	S3
11	GROUND	23	S4
12	GROUND	24	OPEN

Note: Bottom ground plate must be grounded for proper RF performance.

Truth Table

S4	S3	S2	S1	S0	Output
0	0	0	0	0	Reference Input
0	0	0	0	1	0.5 dB
0	0	0	1	0	1 dB
0	0	1	0	0	2 dB
0	1	0	0	0	4 dB
1	0	0	0	0	8 dB
1	1	1	1	1	15.5 dB

Operation: Data on parallel input "S" pins are independently buffered and presented to the RF attenuator circuits. "0" = CMOS Low, "1" = CMOS High.

Evaluation Circuit Board



HRF-AT4510 Evaluation Board

Honeywell's evaluation board provides an easy to use method of evaluating the RF performance of our attenuator. Simply connect power, DC and RF signals to be measuring attenuator performance in less than 10 minutes.

Evaluation Circuit Board Layout Design Details

Item	Description
PCB	Impedance Matched Multi-Layer FR4
Attenuator	HRF-AT4510 Digital Attenuator
Chip Capacitor	Panasonic Model ECU-E1C103KBQ Capacitor, .01uf 0402 10% 16V
RF Connector	Johnson Connectors Model 142-0701-801 SMA RF Coaxial Connector
DC Pin	Mil-Max Model 800-10-064-10-001 Header Pins

Evaluation Circuit Board Connections

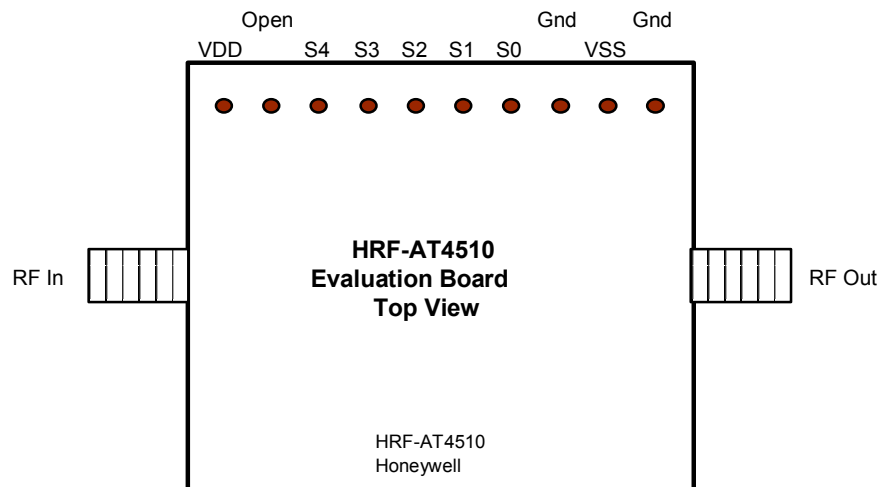

Performance Curves

Insertion Loss

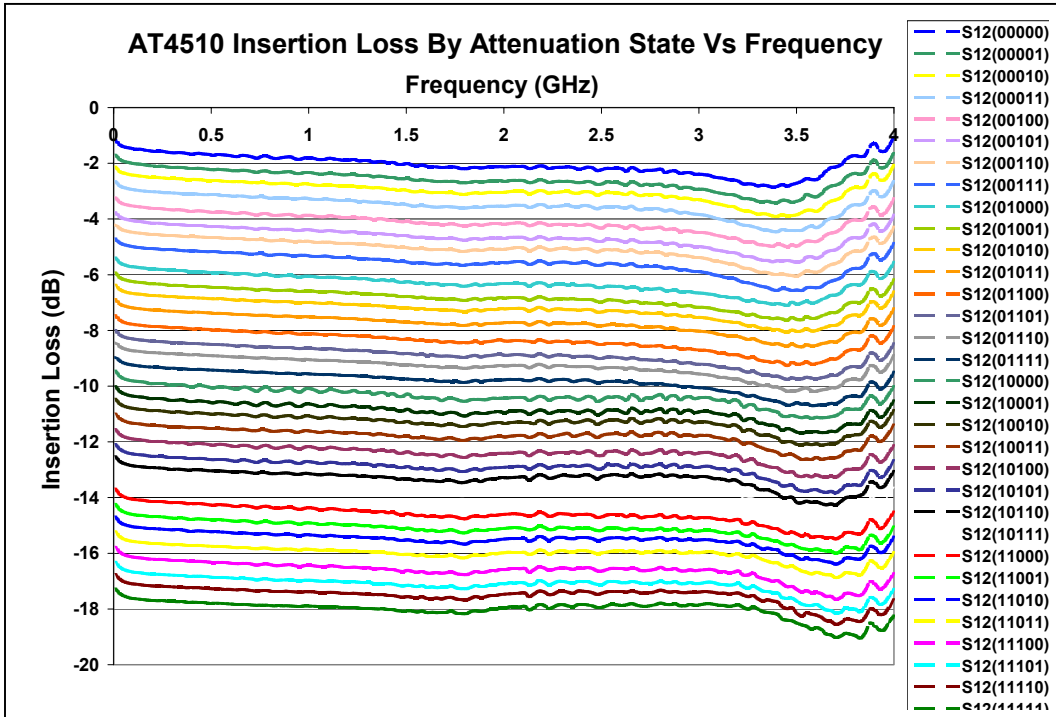

Return Loss

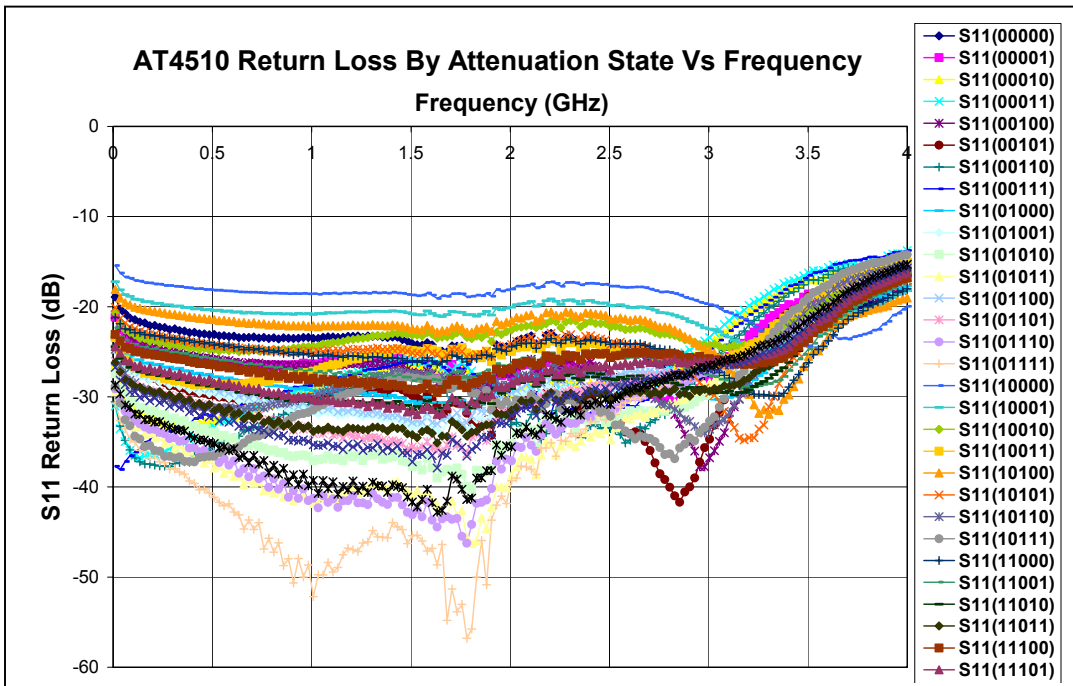

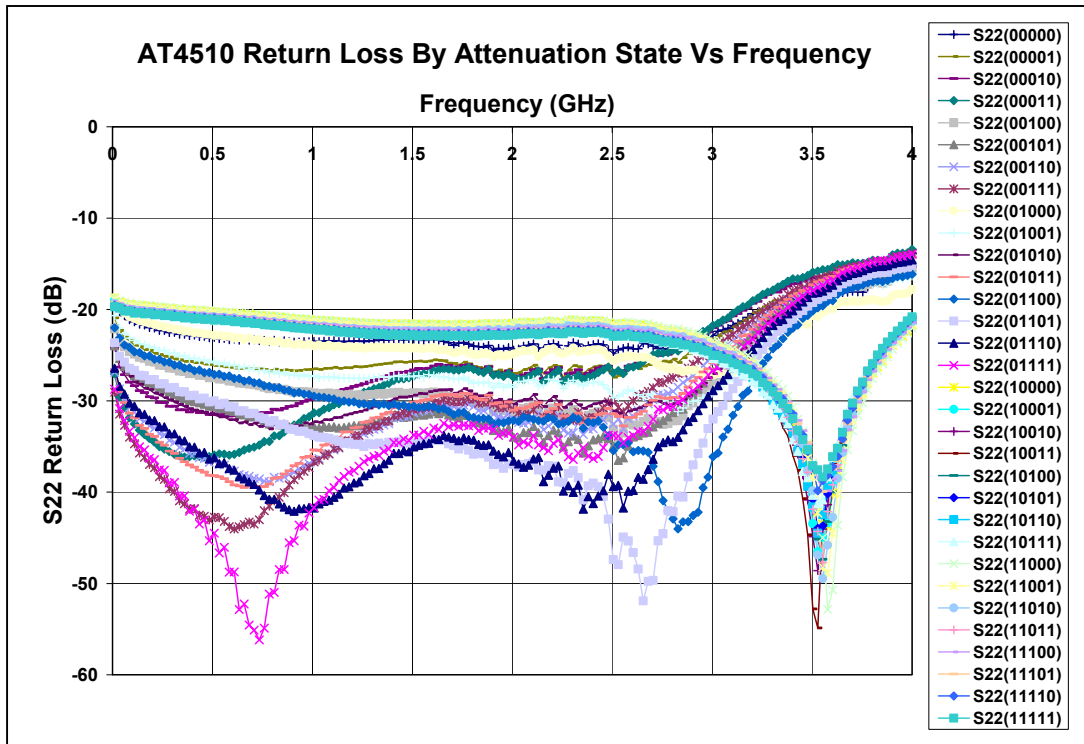

Step Accuracy

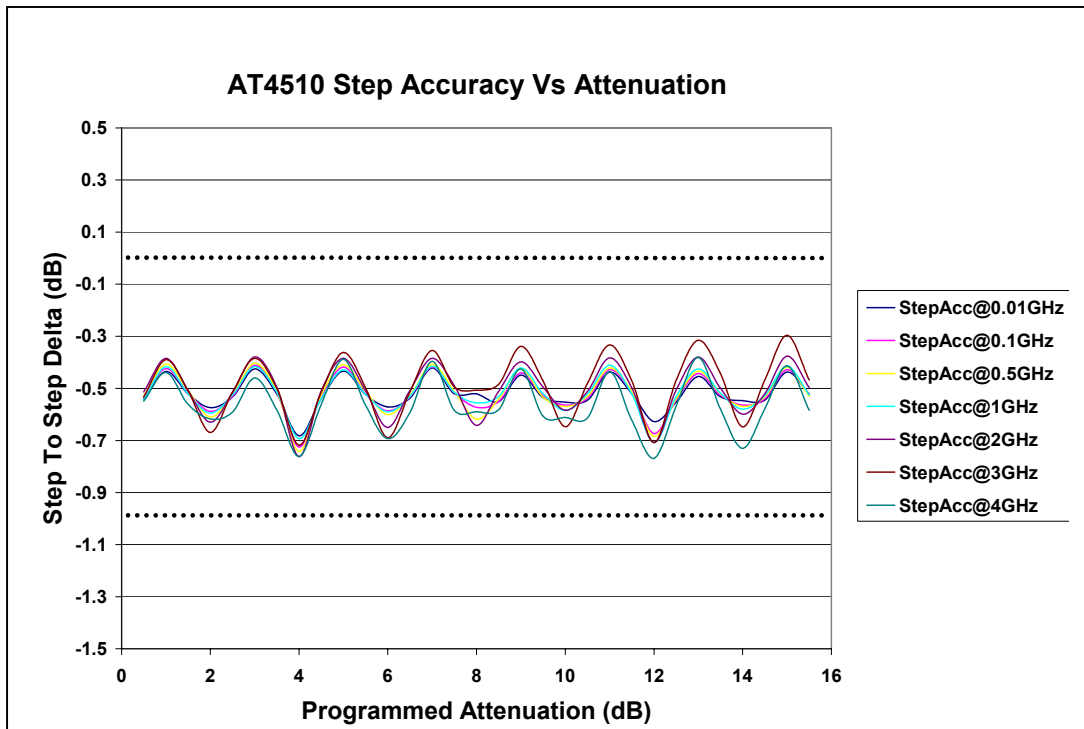

Relative Accuracy

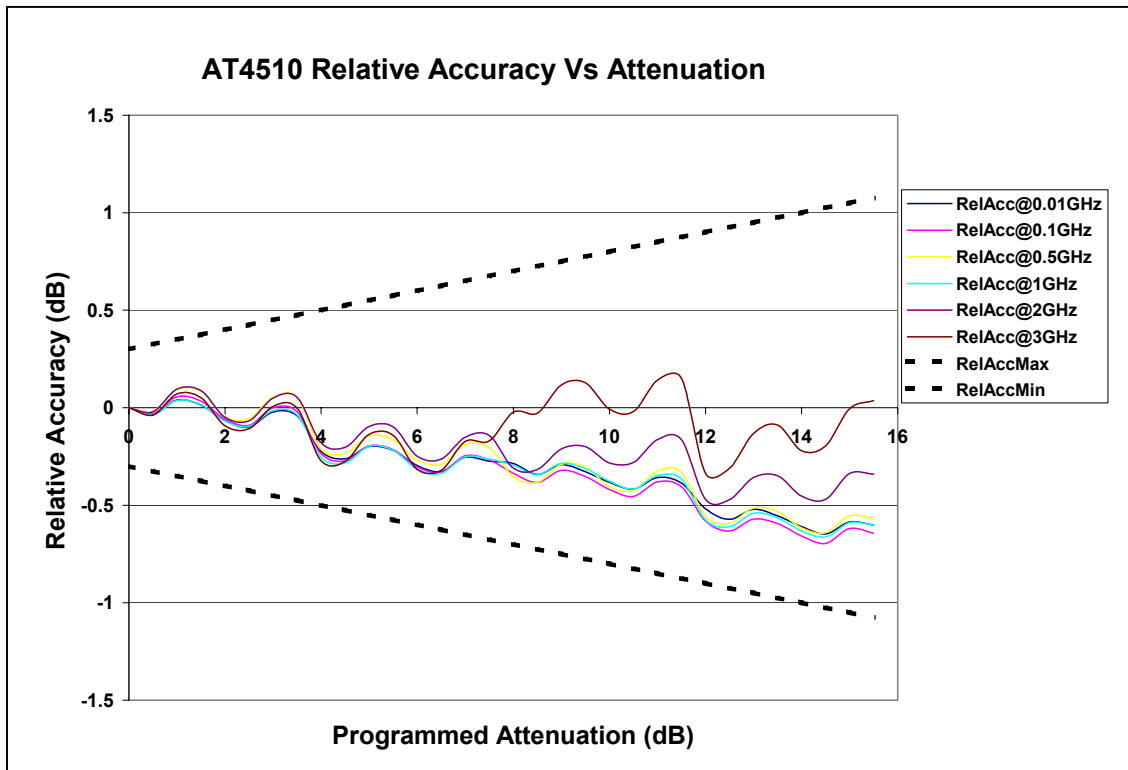

Ordering Information

Ordering Number	Delivery Method	Units Per Shipment
HRF-AT4510-TR	On Tape And Reel ³	3000 Units Per Reel
HRF-AT4510-E	On Individual Engineering Evaluation Board	One Board Per Box

(Note 3) Call Honeywell for details

Honeywell reserves the right to make changes to improve reliability, function or design. Honeywell does not assume any liability arising out of the application or use of any product or circuit described herein; neither does it convey any license under its patent rights nor the rights of others.