

FS6S0965RC

Fairchild Power Switch(SPS)

Features

- Wide operating frequency range up to 150Khz
- Internal Burst mode Controller for Stand-by mode
- Pulse by pulse over current limiting
- Over current protection(Latch mode)
- Over voltage protection (Auto restart mode)
- Over load protection(Auto restart mode)
- Internal thermal shutdown function(Latch mode)
- Under voltage lockout
- Internal high voltage sense FET
- Eternal sync terminal/Soft start

Description

The Fairchild Power Switch(SPS) product family is specially designed for an off line SMPS with minimal external components. The Fairchild Power Switch(SPS) consist of high voltage power SenseFET and current mode PWM IC. Included PWM controller features integrated fixed oscillator, under voltage lock out, optimized gate turn on/turn off driver, thermal shut down protection, over voltage protection, and temperature compensated precision current sources for loop compensation and fault protection circuitry. compared to discrete MOSFET and controller or RCC switching converter solution, a SPS can reduce total component count, design size, and weight and at the same time increase efficiency, productivity, and system reliability. It has a basic platform well suited for cost effective monitor power supply.



Internal Block Diagram

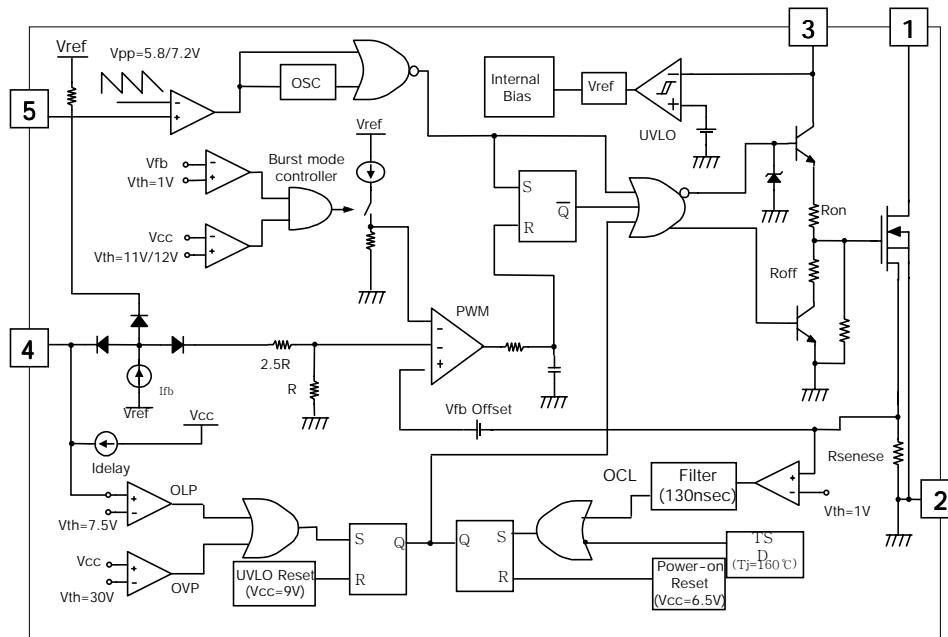

Absolute Maximum Ratings

(Ta=25°C, unless otherwise specified)

| Parameter | Symbol | Value | Unit |
|--|---------------------------|-------------------------|------|
| Drain-source(GND) voltage ⁽¹⁾ | V _{DSS} | 650 | V |
| Drain-Gate Voltage (R _{GS} =1MΩ) | V _{DGR} | 650 | V |
| Gate-source (GND) Voltage | V _{GS} | ±30 | V |
| Drain current pulsed ⁽²⁾ | I _{DM} | 32.4 | ADC |
| Single pulsed avalanche energy ⁽³⁾ | E _{AS} | 515 | mJ |
| Single Pulsed Avalanche current ⁽⁴⁾ | I _{AS} | 25 | A |
| Continuous drain current (T _c = 25°C) | I _D | 8.1 | ADC |
| Continuous drain current (T _C =100°C) | I _D | 5.1 | ADC |
| Supply voltage | V _{CC} | 35 | V |
| Input Voltage Range | V _{FB} | -0.3 to V _{CC} | V |
| | V _{S_S} | -0.3 to 10 | V |
| Total Power Dissipation | P _D (Watt H/S) | 155 | W |
| | Derating | 1.243 | W/°C |
| Operating junction temperature | T _j | +160 | °C |
| Operating Ambient Temperature | T _A | -25 to +85 | °C |
| Storage Temperature range | T _{STG} | -55 to +150 | °C |

Notes:

1. T_j=25°C to 150°C
2. Repetitive rating: Pulse width limited by maximum junction temperature
3. L=14.5mH, starting T_j=25°C
4. L=13uH, starting T_j=25°C

Electrical Characteristics (SFET part)

(Ta=25°C unless otherwise specified)

| Parameter | Symbol | Condition | Min. | Typ. | Max. | Unit |
|---|---------|---|------|------|------|------|
| Drain-source breakdown voltage | BVDSS | VGS=0V, ID=250μA | 650 | - | - | V |
| Zero gate voltage drain current | IDSS | VDS=650V, VGS=0V | - | - | 200 | μA |
| | | VDS=520V VGS=0V, TC=125°C | - | - | 300 | μA |
| Static drain-source on resistance ^(note) | RDS(ON) | VGS=10V, ID=1.8A | - | 1.0 | 1.2 | Ω |
| Forward transconductance ^(note) | gfs | VDS=50V, ID=1.8A | - | - | - | S |
| Input capacitance | Ciss | VGS=0V, VDS=25V, f = 1MHz | - | 1300 | - | pF |
| Output capacitance | Coss | | - | 135 | - | |
| Reverse transfer capacitance | Crss | | - | 25 | - | |
| Turn on delay time | td(on) | VDD=325V, ID=6.5A (MOSFET switching time are essentially independent of operating temperature) | - | 25 | - | nS |
| Rise time | tr | | - | 75 | - | |
| Turn off delay time | td(off) | | - | 130 | - | |
| Fall time | tf | | - | 70 | - | |
| Total gate charge (gate-source+gate-drain) | Qg | VGS=10V, ID=6.5A, VDS=520V (MOSFET Switching time are Essentially independent of Operating temperature) | - | 45 | 60 | nC |
| Gate-source charge | Qgs | | - | 8 | - | |
| Gate-drain (Miller) charge | Qgd | | - | 21 | - | |

Note:

Pulse test : Pulse width ≤ 300μS, duty 2%

$$S = \frac{1}{R}$$

Electrical Characteristics

(Ta=25°C unless otherwise specified)

| Parameter | Symbol | Condition | Min. | Typ. | Max. | Unit |
|------------------------------------|---------|------------------------|------|------|------|------|
| UVLO SECTION | | | | | | |
| Start threshold voltage | VSTART | VFB=GND | 14 | 15 | 16 | V |
| Stop threshold voltage | VSTOP | VFB=GND | 8 | 9 | 10 | V |
| SENSEFET SECTION | | | | | | |
| Drain to PKG Breakdown voltage | BVpkg | 60HZ AC, Ta=25°C | 3500 | - | - | V |
| Drain to Source Breakdown voltage | BVdss | Vdrain = 650V, Ta=25°C | 650 | - | - | V |
| Drain to Source Leakage current | Idss | Vdrain = 650V, Ta=25°C | - | - | 300 | uA |
| OSCILLATOR SECTION | | | | | | |
| Initial Frequency | FOSC | - | 22 | 25 | 28 | kHz |
| Voltage Stability | FSTABLE | 12V ≤ Vcc ≤ 23V | 0 | 1 | 3 | % |
| Temperature Stability (note4) | ΔFOSC | -25°C ≤ Ta ≤ 85°C | 0 | ±5 | ±10 | % |
| Maximum duty cycle | DMAX | - | 92 | 95 | 98 | % |
| Minimum Duty Cycle | DMIN | - | - | - | 0 | % |
| FEEDBACK SECTION | | | | | | |
| Feedback source current | IFB | VFB=GND | 0.7 | 0.9 | 1.1 | mA |
| Shutdown Feedback voltage | VSD | Vfb ≥ 6.9V | 6.9 | 7.5 | 8.1 | V |
| Shutdown delay current | Idelay | VFB=5V | 1.6 | 2.0 | 2.4 | μA |
| PROTECTION SECTION | | | | | | |
| Over Voltage Protection | VOVP | Vsync ≥ 11V | 27 | 30 | 33 | V |
| Over Current Latch Voltage (Note2) | VOCL | - | 0.9 | 1.0 | 1.1 | V |
| Thermal Shutdown Temp.(Note4) | TSD | - | 140 | 160 | - | °C |

Electrical Characteristics (Continued)

(Ta=25°C unless otherwise specified)

| Parameter | Symbol | Condition | Min. | Typ. | Max. | Unit |
|--|----------|-------------------|------|------|------|------|
| Sync & SOFTSTART SECTION | | | | | | |
| Softstart Voltage | VSS | Vfb=2 | 4.7 | 5.0 | 5.3 | V |
| Softstart Current | ISS | Vss=V | 0.8 | 1.0 | 1.2 | mA |
| Sync High Threshold Voltage | VSYNCH | Vcc=16V,Vfb=5V | - | 7.2 | - | V |
| Sync Low Threshold Voltage | VSYNCL | Vcc=16V,Vfb=5V | - | 5.8 | - | V |
| BURST MODE SECTION | | | | | | |
| Burst mode Low Threshold Voltage | VBURL | Vfb=0V | 10.4 | 11.0 | 11.6 | V |
| Burst mode High Threshold Voltage | VBURH | Vfb=0V | 11.4 | 12.0 | 12.6 | V |
| Burst mode Enable Feedback Voltage(Note4) | VBEN | Vcc=10.5V | 0.7 | 1.0 | 1.3 | V |
| Burst mode Peak Current Limit(Note3) | IBU_PK | Vcc=10.5V | 0.6 | 0.85 | 1.1 | V |
| Burst mode Frequency | FBUR | Vcc=10.5V, Vfb=0V | 40 | 50 | 60 | KHz |
| CURRENT LIMIT(SELF-PROTECTION)SECTION | | | | | | |
| Peak Current Limit(Note3) | IOVER | - | 5.28 | 6.0 | 6.72 | A |
| TOTAL DEVICE SECTION | | | | | | |
| Start Up current | ISTART | Vfb=GND, VCC=14V | - | 0.1 | 0.17 | mA |
| Operating supply current (Note1) | IOP | Vfb=GND, VCC=16V | - | 10 | 15 | mA |
| | IOP(MIN) | Vfb=GND, VCC=10V | | | | |
| | IOP(MAX) | Vfb=GND, VCC=28V | | | | |

Note:

- (1) These parameters is the current flowing in the Control IC.
- (2) These parameters, although guaranteed, are tested in EDS(wafer test) process.
- (3) These parameters indicate Inductor Current.
- (4) These parameters, although guranteed at the design, are not tested in massing production.

Typical Performance Characteristics

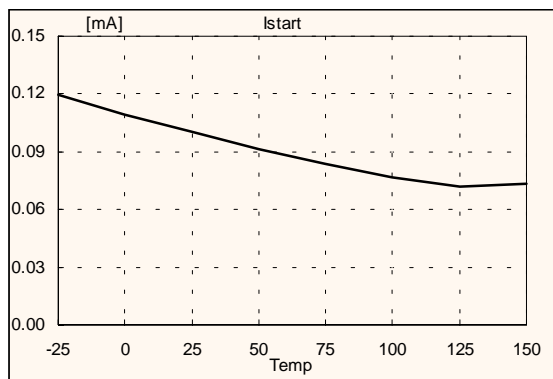

Figure 1. Start Up Current vs. Temp.

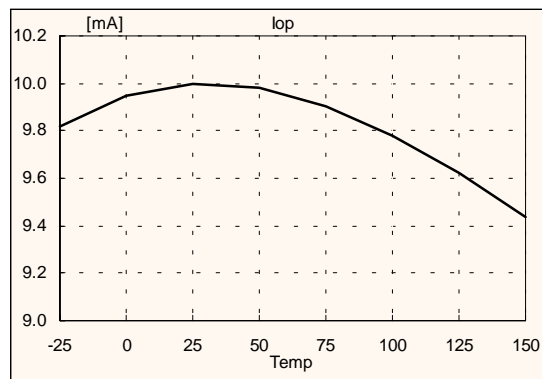

Figure 2. Operating Supply Current vs. Temp.

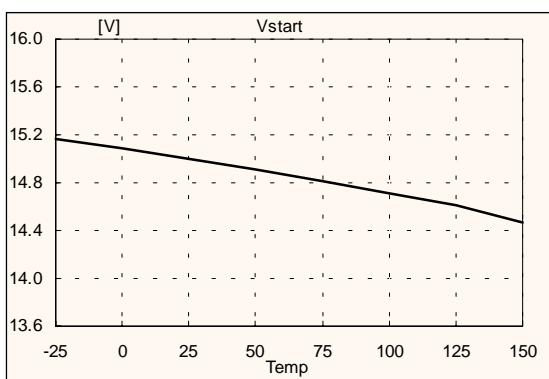

Figure 3. Start Threshold Voltage vs. Temp.

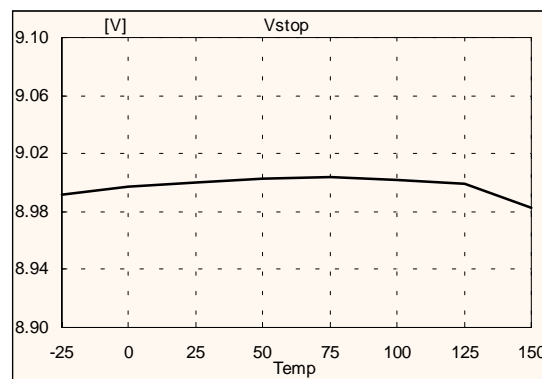

Figure 4. Stop Threshold Voltage vs. Temp.

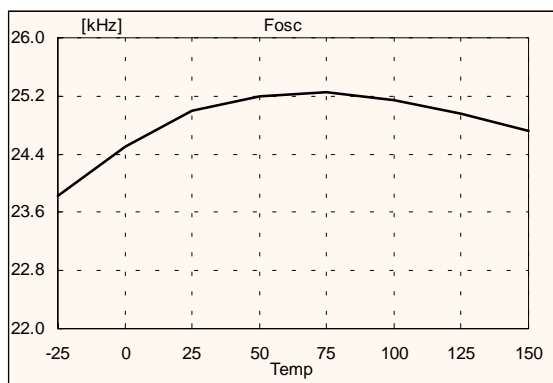

Figure 5. Initial Frequency vs. Temp.

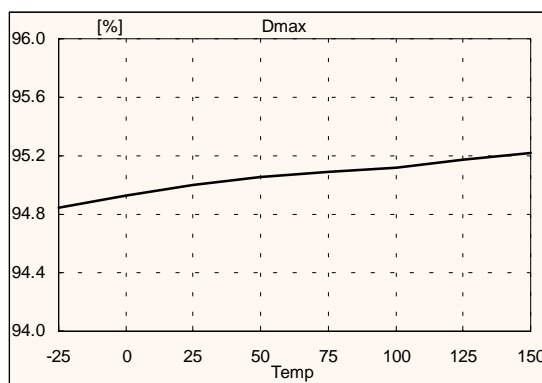

Figure 6. Maximum Duty vs. Temp.

Typical Performance Characteristics (Continued)

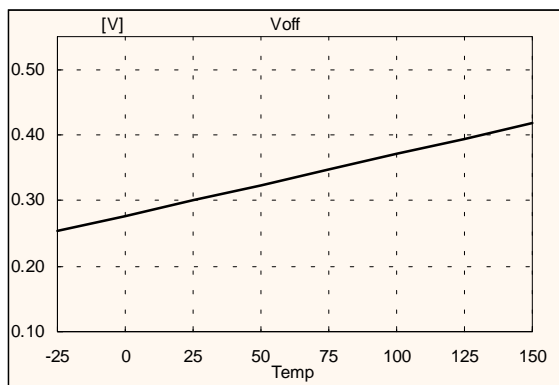

Figure 7. Feedback Offset Voltage vs. Temp.

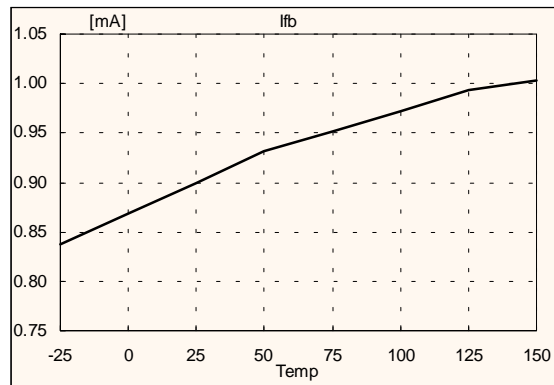

Figure 8. Feedback Source Current vs. Temp.

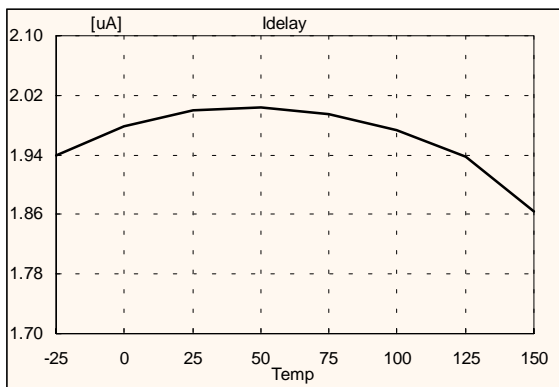

Figure 9. Shutdown Delay Current vs. Temp.

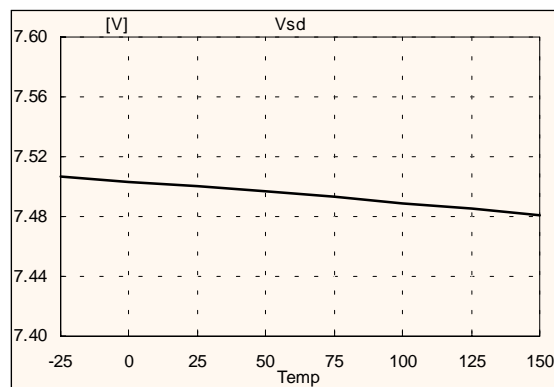

Figure 10. Shutdown Feedback Voltage vs. Temp.

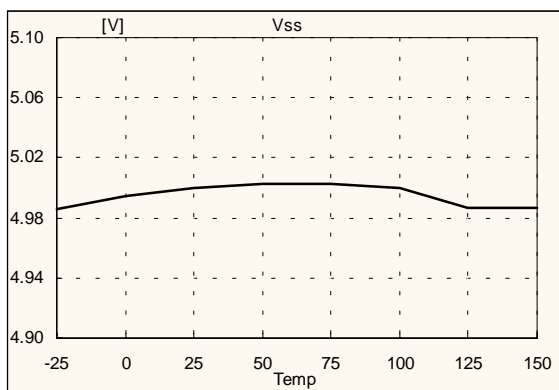

Figure 11. Softstart Voltage vs. Temp.

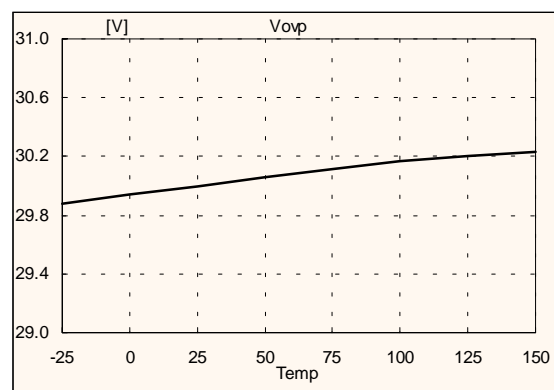

Figure 12. Over Voltage Protection vs. Temp.

Typical Performance Characteristics (Continued)

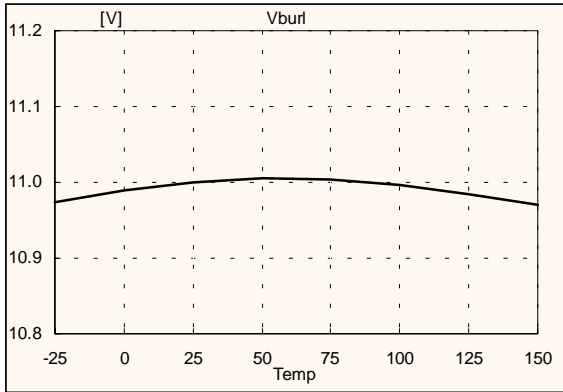

Figure 13. Burst Mode Low Voltage vs. Temp.

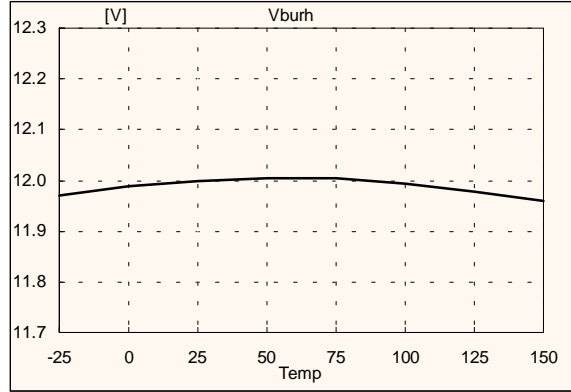

Figure 14. Burst Mode High Voltage vs. Temp.

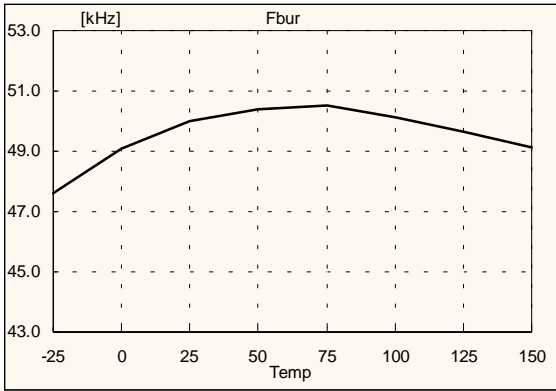

Figure 15. Burst Mode Frequency vs. Temp.

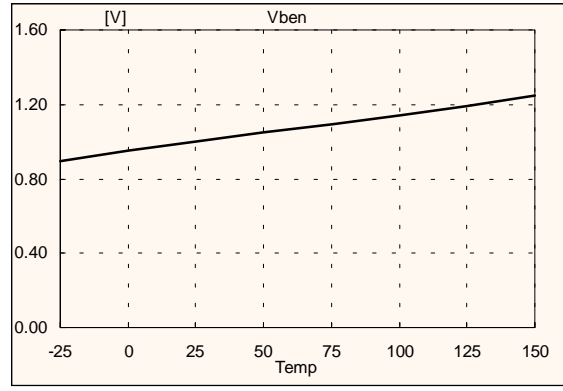

Figure 16. Burst Mode Enable Voltage vs. Temp.

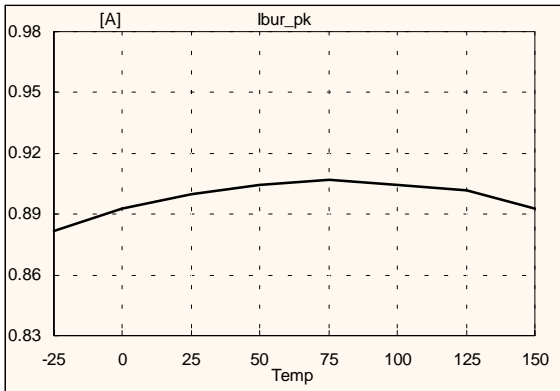

Figure 17. Burst Mode Peak Current vs. Temp.

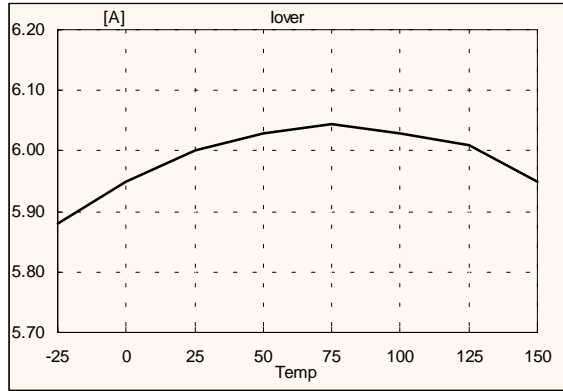
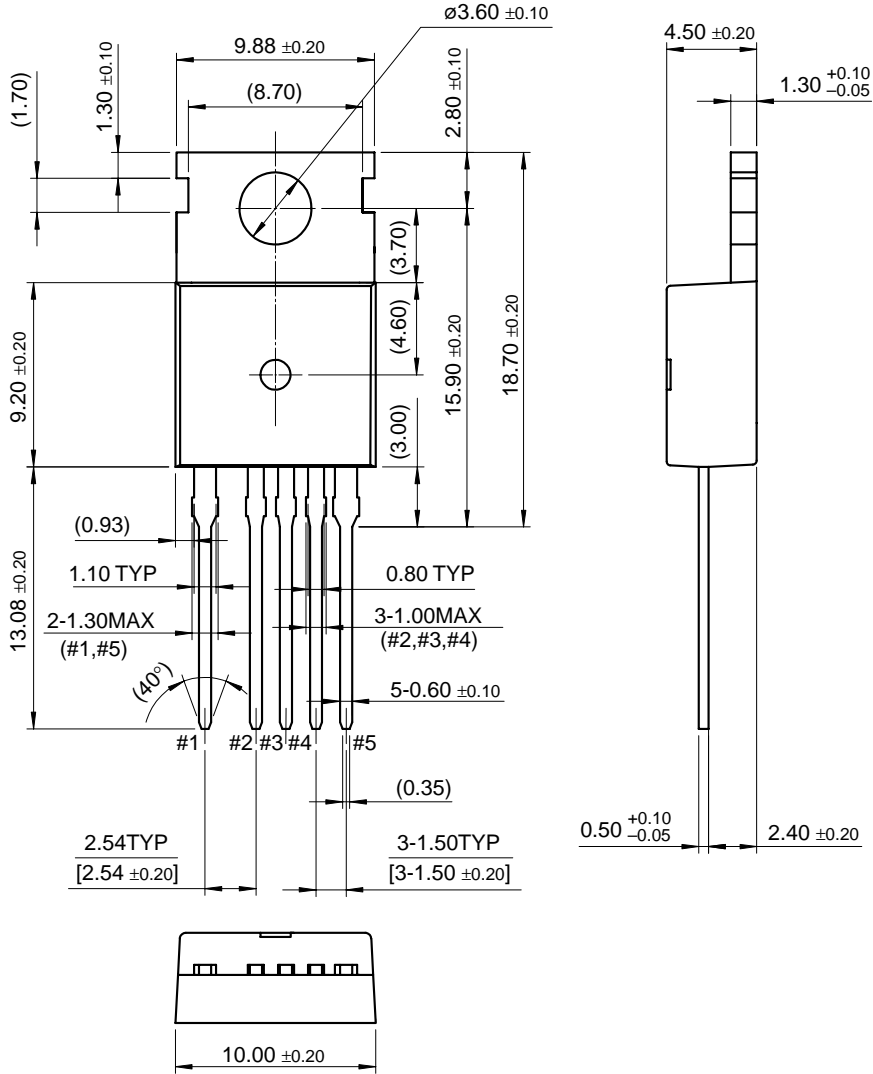

Figure 18. Peak Current Limit vs. Temp.

Package Dimensions

TO-220-5L



Package Dimensions (Continued)

TO-220-5L(Forming)

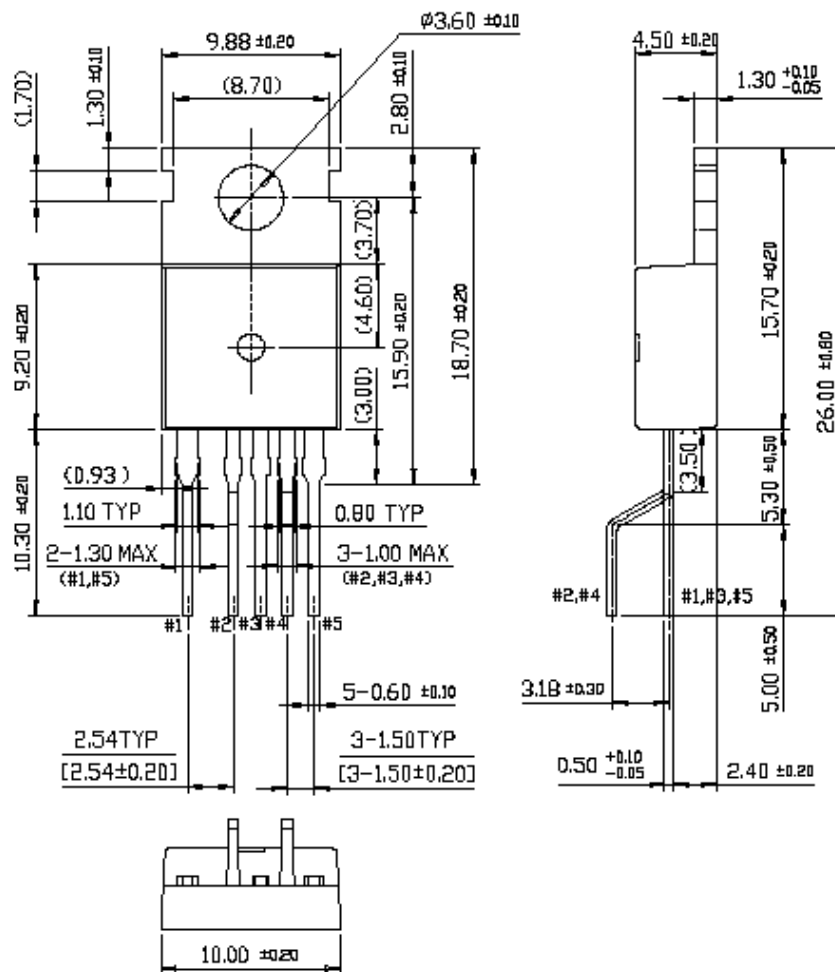

Ordering Information

| Product Number | Package | Marking Code | BVdss | Rds(on) |
|-----------------|--------------------|--------------|-------|---------|
| FS6S0965RC-TU | TO-220-5L | 6S0965RC | 650V | 1.0 |
| FS6S0965RC-YDTU | TO-220-5L(Forming) | | | |

TU : Non Forming Type

YDTU : Forming Type

DISCLAIMER

FAIRCHILD SEMICONDUCTOR RESERVES THE RIGHT TO MAKE CHANGES WITHOUT FURTHER NOTICE TO ANY PRODUCTS HEREIN TO IMPROVE RELIABILITY, FUNCTION OR DESIGN. FAIRCHILD DOES NOT ASSUME ANY LIABILITY ARISING OUT OF THE APPLICATION OR USE OF ANY PRODUCT OR CIRCUIT DESCRIBED HEREIN; NEITHER DOES IT CONVEY ANY LICENSE UNDER ITS PATENT RIGHTS, NOR THE RIGHTS OF OTHERS.

LIFE SUPPORT POLICY

FAIRCHILD'S PRODUCTS ARE NOT AUTHORIZED FOR USE AS CRITICAL COMPONENTS IN LIFE SUPPORT DEVICES OR SYSTEMS WITHOUT THE EXPRESS WRITTEN APPROVAL OF THE PRESIDENT OF FAIRCHILD SEMICONDUCTOR CORPORATION. As used herein:

1. Life support devices or systems are devices or systems which, (a) are intended for surgical implant into the body, or (b) support or sustain life, and (c) whose failure to perform when properly used in accordance with instructions for use provided in the labeling, can be reasonably expected to result in a significant injury of the user.
2. A critical component in any component of a life support device or system whose failure to perform can be reasonably expected to cause the failure of the life support device or system, or to affect its safety or effectiveness.