

FDR8321L P-Channel MOSFET With Gate Driver For Load Switch Application

General Description

This device is designed for configuration as a load switch and is particularly suited for Power Management in portable battery powered electronic equipment. Designed to operate from 2.5V to 8V input and supply up to 2.9A. The device features a small N-Channel MOSFET (Q1) together with a large P-Channel power MOSFET (Q2) in a single SuperSOT™-8 package.

Features

- $V_{\text{DROP}} = 0.2\text{V}$ @ $V_{\text{IN}} = 5\text{V}$, $I_{\text{L}} = 2.9\text{A}$. $R_{\text{DS(ON)}} = 0.070\ \Omega$
 $V_{\text{DROP}} = 0.2\text{V}$ @ $V_{\text{IN}} = 2.5\text{V}$, $I_{\text{L}} = 2\text{A}$. $R_{\text{DS(ON)}} = 0.105\ \Omega$.
- $V_{\text{ON/OFF}}$ Zener protection for ESD ruggedness (>6KV Human Body Model).
- High density cell design for extremely low on-resistance.

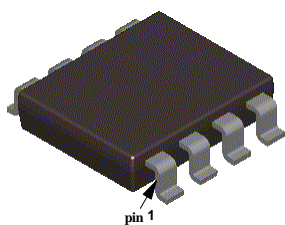
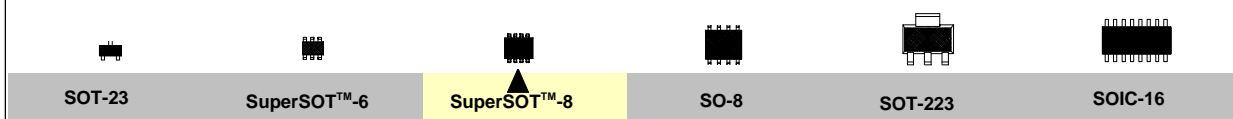

SuperSOT™-8

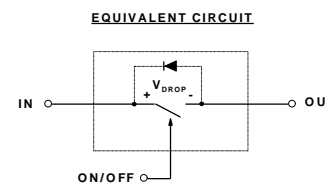
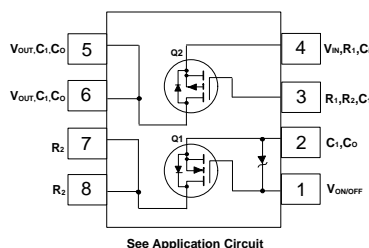

Absolute Maximum Ratings $T_A = 25^\circ\text{C}$ unless otherwise noted

| Symbol | Parameter | FDR8321L | Units |
|--------------------------------|--|------------|------------------|
| V_{IN} | Input Voltage Range | 2.5 - 8 | V |
| $V_{\text{ON/OFF}}$ | On/Off Voltage Range | 1.5 - 8 | V |
| I_{L} | Load Current @ $V_{\text{DROP}} = 0.2\text{V}$ - Continuous (Note 1) | 2.9 | A |
| | | - Pulsed | |
| P_{D} | Maximum Power Dissipation (Note 2) | 0.8 | W |
| $T_{\text{J}}, T_{\text{STG}}$ | Operating and Storage Temperature Range | -55 to 150 | $^\circ\text{C}$ |

THERMAL CHARACTERISTICS

| | | | |
|-----------------------|--|-----|--------------------|
| $R_{\theta\text{JA}}$ | Thermal Resistance, Junction-to-Ambient (Note 2) | 156 | $^\circ\text{C/W}$ |
| $R_{\theta\text{JC}}$ | Thermal Resistance, Junction-to-Case (Note 2) | 40 | $^\circ\text{C/W}$ |

Electrical Characteristics (T_A = 25°C unless otherwise noted)

| Symbol | Parameter | Conditions | Min | Typ | Max | Units |
|------------------------------------|--|---|-----|-------|-------|-------|
| OFF CHARACTERISTICS | | | | | | |
| I _{FL} | Forward Leakage Current | V _{IN} = 5 V, V _{ON/OFF} = 0 V | | | 1 | μA |
| ON CHARACTERISTICS (Note 3) | | | | | | |
| V _{DROP} | Conduction Voltage Drop | V _{IN} = 5 V, V _{ON/OFF} = 3.3 V, I _L = 2.9 A | | 0.185 | 0.2 | V |
| | | V _{IN} = 2.5 V, V _{ON/OFF} = 3.3 V, I _L = 2 A | | 0.18 | 0.2 | |
| R _{DS(ON)} | Q ₂ - Static Drain-Source On-Resistance | V _{GS} = -5 V, I _D = -2.9 A | | 0.06 | 0.07 | Ω |
| | | V _{GS} = -2.5 V, I _D = -2 A | | 0.09 | 0.105 | |
| I _L | Load Current | V _{DROP} = 0.2 V, V _{IN} = 5 V, V _{ON/OFF} = 3.3 V | 2.9 | | | A |
| | | V _{DROP} = 0.2 V, V _{IN} = 2.5 V, V _{ON/OFF} = 3.3 V | 2 | | | |

Notes:

- V_{IN}=5V, V_{ON/OFF}=8V, V_{DROP}=0.2V, T_A=25°C
- R_{θJA} is the sum of the junction-to-case and case-to-ambient thermal resistance where the case thermal reference is defined as the solder mounting surface of the drain pins. R_{θJC} is guaranteed by design while R_{θCA} is determined by the user's board design. R_{θJA} typical =156°C/W when mounted on a minimum 0.0025 in² pad on FR-4.
- Pulse Test: Pulse Width ≤ 300μs, Duty Cycle ≤ 2.0%

FDR8321L Load Switch Application

APPLICATION CIRCUIT

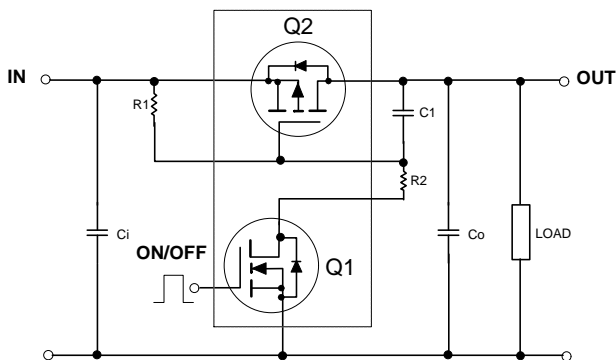

External Component Recommendation

First select R2, 100 - 1kΩ, for Slew Rate control.

C1 ≤ 1000pF can be added in addition to R2 for further In-rush current control.

Then select R1 such that R1/R2 ratio maintains between 10 - 100. R1 is required to turn Q2 off.

For SPICE simulation, users can download a "FDR8321L.MOD" Spice model from Fairchild Web Site at www.fairchildsemi.com

Typical Electrical Characteristics ($T_A = 25^\circ\text{C}$ unless otherwise noted)

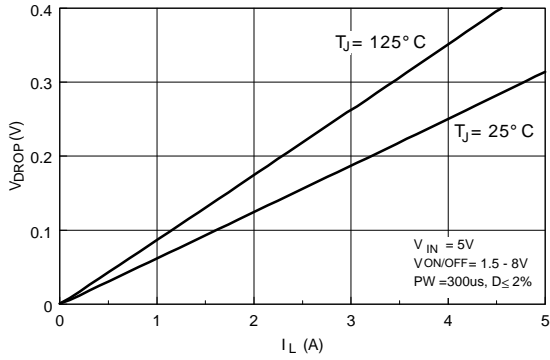

Figure 1. Conduction Voltage Drop versus Load Current at Input Voltage 5V.

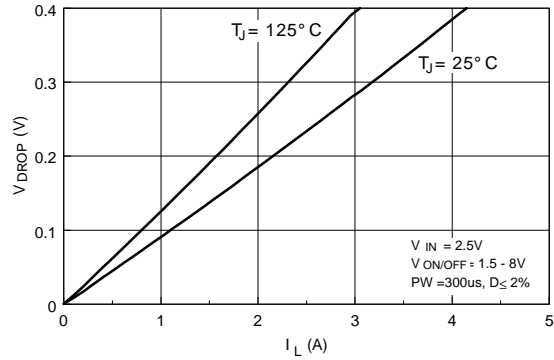

Figure 2. Conduction Voltage Drop versus Load Current at Input Voltage 2.5V.

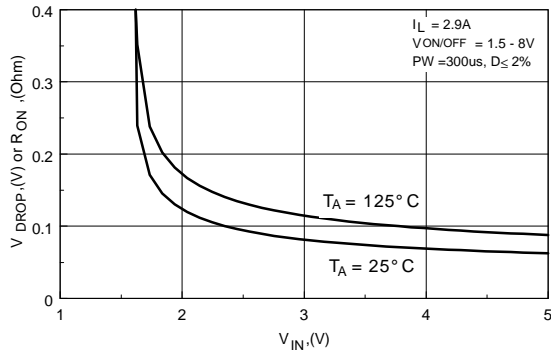

Figure 3. Conduction Voltage Drop versus input Voltage at Load Current 2.9A.

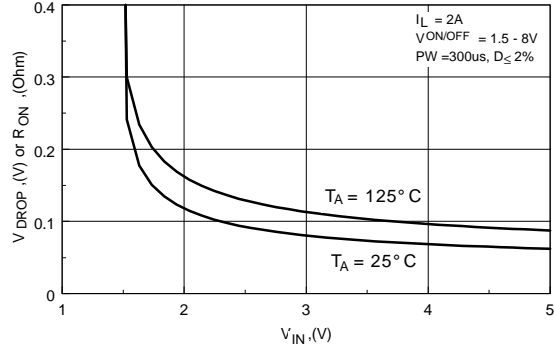

Figure 4. Conduction Voltage Drop versus Input Voltage at Load Current 2A.

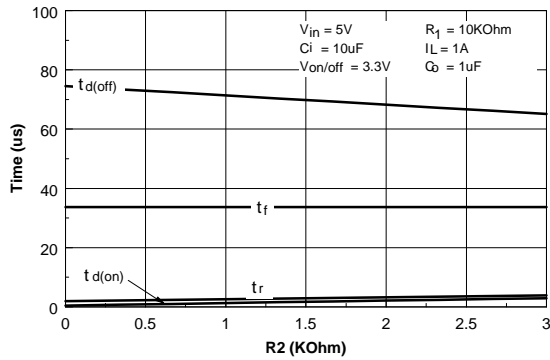

Figure 5. Switching Variation with R_2 at $V_{in} = 5\text{V}$ and $R_1 = 10\text{K}\Omega$.

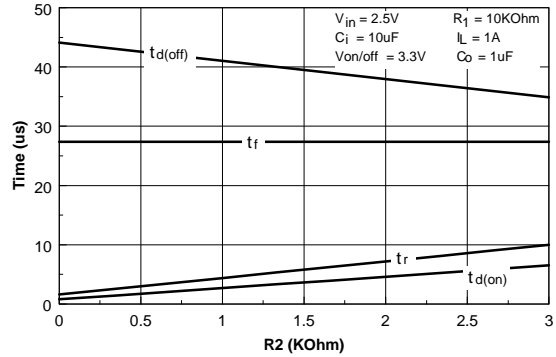

Figure 6. Switching Variation with R_2 at $V_{in} = 2.5\text{V}$ and $R_1 = 10\text{K}\Omega$.

Typical Electrical Characteristics ($T_A = 25\text{ }^\circ\text{C}$ unless otherwise noted)

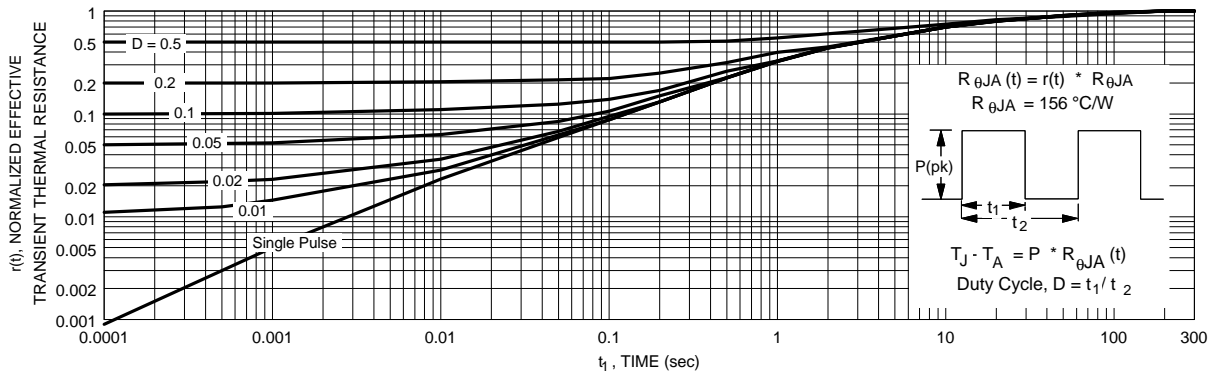

Figure 7. Transient Thermal Response Curve.

Thermal characterization performed on the conditions described in Note 2.

SuperSOT™-8 Tape and Reel Data and Package Dimensions



SSOT-8 Packaging Configuration: Figure 1.0

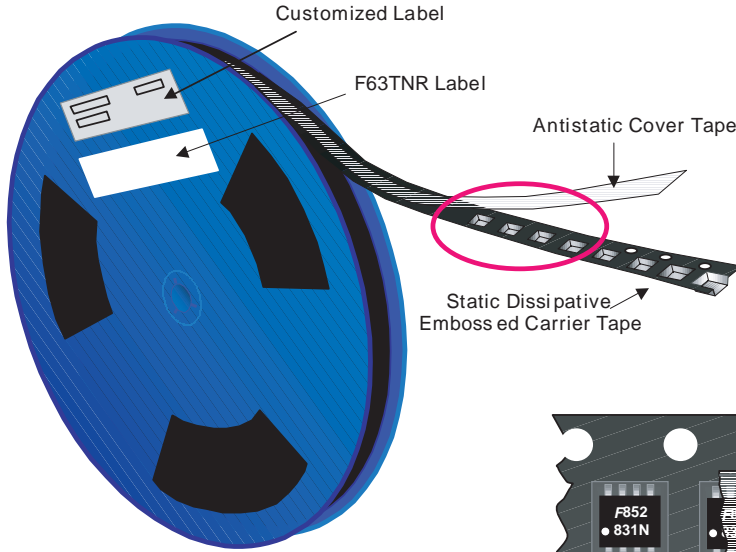

Packaging Description:

SSOT-8 parts are shipped in tape. The carrier tape is made from a dissipative (carbon filled) polycarbonate resin. The cover tape is a multilayer film (Heat Activated Adhesive in nature) primarily composed of polyester film, adhesive layer, sealant, and anti-static sprayed agent. These reeled parts in standard option are shipped with 3,000 units per 13" or 330cm diameter reel. The reels are dark blue in color and is made of polystyrene plastic (anti-static coated). Other option comes in 500 units per 7" or 177cm diameter reel. This and some other options are further described in the Packaging Information table.

These full reels are individually barcode labeled and placed inside a standard intermediate box (illustrated in figure 1.0) made of recyclable corrugated brown paper. One box contains two reels maximum. And these boxes are placed inside a barcode labeled shipping box which comes in different sizes depending on the number of parts shipped.

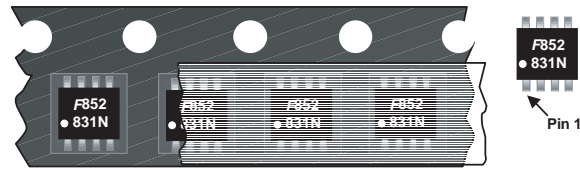

SSOT-8 Unit Orientation

| SSOT-8 Packaging Information | | |
|------------------------------|-------------------------|------------|
| Packaging Option | Standard (no flow code) | D84Z |
| Packaging type | TNR | TNR |
| Qty per Reel/Tube/Bag | 3,000 | 500 |
| Reel Size | 13" Dia | 7" Dia |
| Box Dimension (mm) | 343x64x343 | 184x187x47 |
| Max qty per Box | 6,000 | 1,000 |
| Weight per unit (gm) | 0.0416 | 0.0416 |
| Weight per Reel (kg) | 0.5615 | 0.0980 |
| Note/Comments | | |

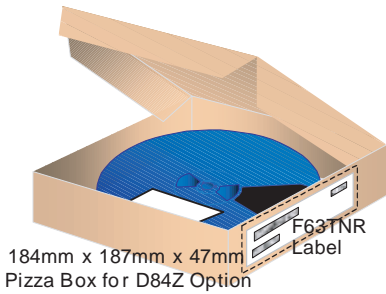
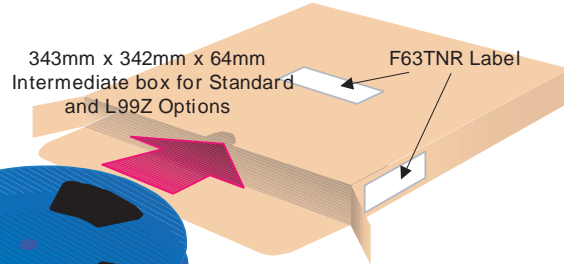

F63TNR Label sample



SSOT-8 Tape Leader and Trailer Configuration: Figure 2.0

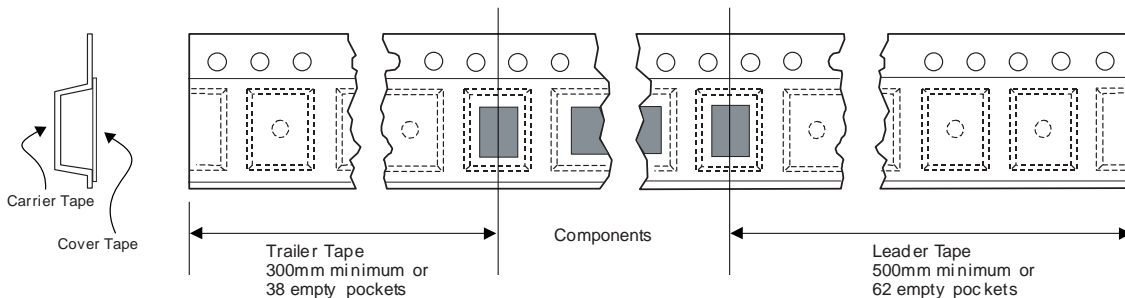

SuperSOT™-8 Tape and Reel Data and Package Dimensions, continued

SSOT-8 Embossed Carrier Tape Configuration: Figure 3.0

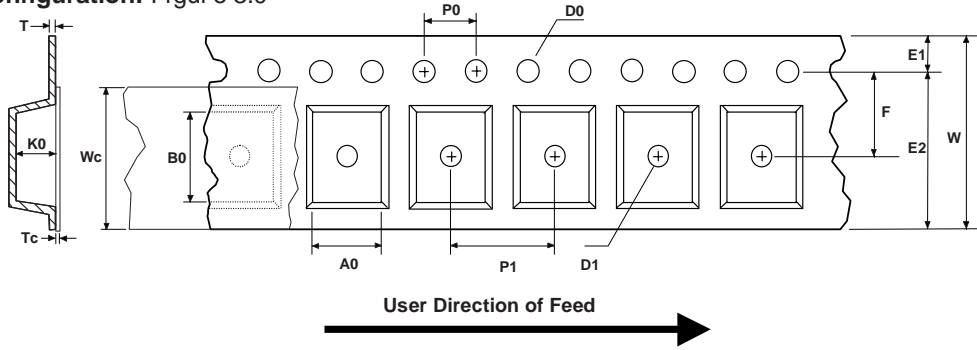

Dimensions are in millimeter

| Pkg type | A0 | B0 | W | D0 | D1 | E1 | E2 | F | P1 | P0 | K0 | T | Wc | Tc |
|---------------|-----------------|-----------------|----------------|-----------------|-----------------|-----------------|--------------|-----------------|---------------|---------------|-----------------|-------------------|-----------------|-----------------|
| SSOT-8 (12mm) | 4.47 +/-0.10 | 5.00 +/-0.10 | 12.0 +/-0.3 | 1.55 +/-0.05 | 1.50 +/-0.10 | 1.75 +/-0.10 | 10.25 min | 5.50 +/-0.05 | 8.0 +/-0.1 | 4.0 +/-0.1 | 1.37 +/-0.10 | 0.280 +/-0.150 | 9.5 +/-0.025 | 0.06 +/-0.02 |

Notes: A0, B0, and K0 dimensions are determined with respect to the EIA/Jedec RS-481 rotational and lateral movement requirements (see sketches A, B, and C).

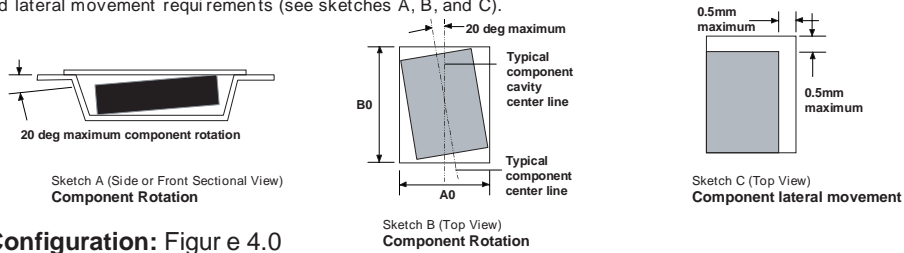

SSOT-8 Reel Configuration: Figure 4.0

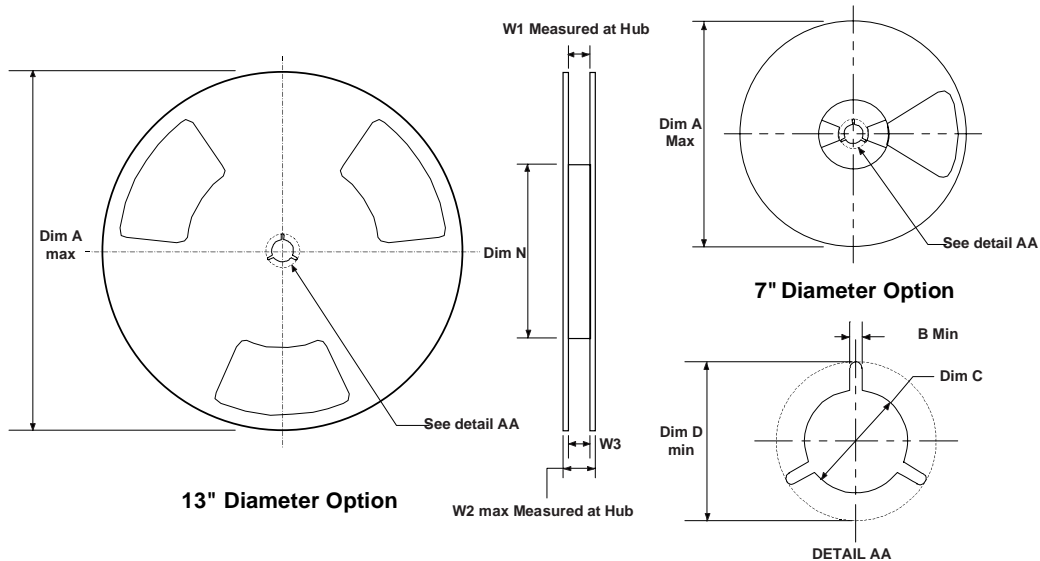

Dimensions are in inches and millimeters

| Tape Size | Reel Option | Dim A | Dim B | Dim C | Dim D | Dim N | Dim W1 | Dim W2 | Dim W3 (LSL-USL) |
|-----------|-------------|---------------|--------------|-----------------------------------|---------------|--------------|----------------------------------|---------------|------------------------------|
| 12mm | 7" Dia | 7.00 177.8 | 0.059 1.5 | 512 +0.020/-0.008 13 +0.5/-0.2 | 0.795 20.2 | 5.906 150 | 0.488 +0.078/-0.000 12.4 +2/0 | 0.724 18.4 | 0.469 - 0.606 11.9 - 15.4 |
| 12mm | 13" Dia | 13.00 330 | 0.059 1.5 | 512 +0.020/-0.008 13 +0.5/-0.2 | 0.795 20.2 | 7.00 178 | 0.488 +0.078/-0.000 12.4 +2/0 | 0.724 18.4 | 0.469 - 0.606 11.9 - 15.4 |

SuperSOT™-8 Tape and Reel Data and Package Dimensions, continued

SuperSOT™-8 (FS PKG Code 34, 35)

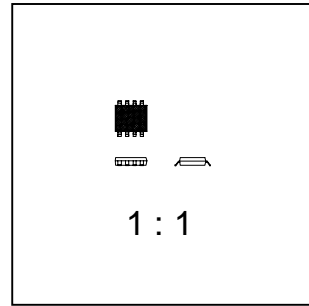
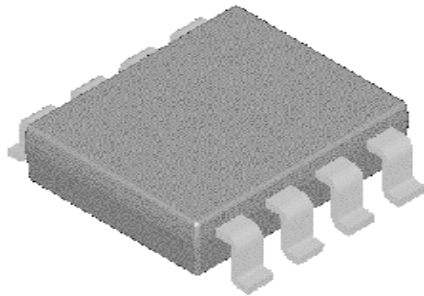

Scale 1:1 on letter size paper

Dimensions shown below are in:
inches [millimeters]

Part Weight per unit (gram): 0.0416

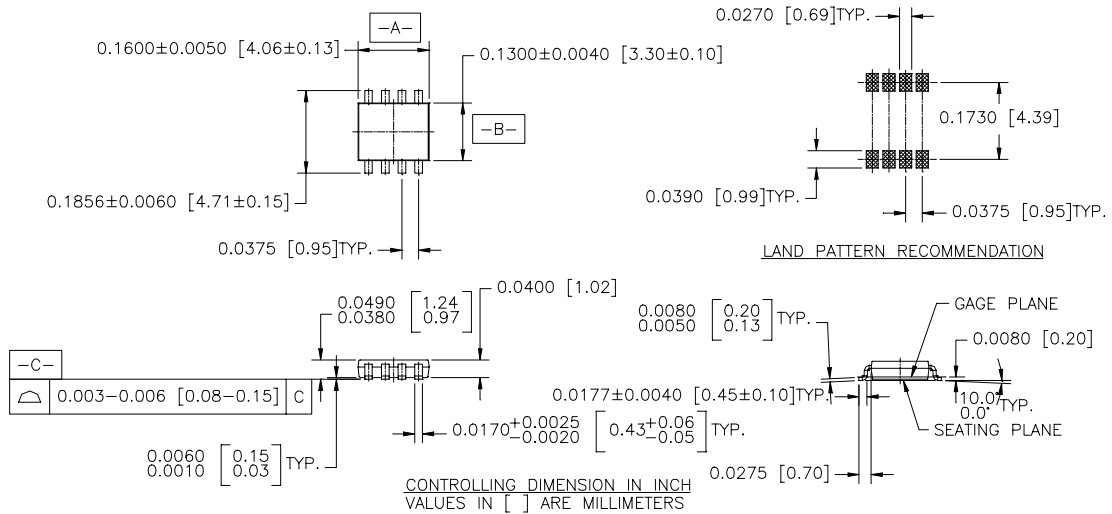

NOTES : UNLESS OTHERWISE SPECIFIED

- STANDARD LEAD FINISH TO BE 200 MICRONS / 5.08 MICROMETERS MINIMUM TIN/LEAD (SOLDER) ON COPPER.
- NO JEDEC REGISTRATION AS JAN. 1996

SUPER SOT, 8 LEADS

TRADEMARKS

The following are registered and unregistered trademarks Fairchild Semiconductor owns or is authorized to use and is not intended to be an exhaustive list of all such trademarks.

| | | | |
|----------------------|---------------------|---------------------|------|
| ACEx™ | FASTr™ | QFET™ | VCX™ |
| Bottomless™ | GlobalOptoisolator™ | QS™ | |
| CoolFET™ | GTO™ | QT Optoelectronics™ | |
| CROSSVOLT™ | HiSeC™ | Quiet Series™ | |
| DOME™ | ISOPANAR™ | SuperSOT™-3 | |
| E ² CMOS™ | MICROWIRE™ | SuperSOT™-6 | |
| EnSigna™ | OPTOLOGIC™ | SuperSOT™-8 | |
| FACT™ | OPTOPLANAR™ | SyncFET™ | |
| FACT Quiet Series™ | POP™ | TinyLogic™ | |
| FAST® | PowerTrench® | UHC™ | |

DISCLAIMER

FAIRCHILD SEMICONDUCTOR RESERVES THE RIGHT TO MAKE CHANGES WITHOUT FURTHER NOTICE TO ANY PRODUCTS HEREIN TO IMPROVE RELIABILITY, FUNCTION OR DESIGN. FAIRCHILD DOES NOT ASSUME ANY LIABILITY ARISING OUT OF THE APPLICATION OR USE OF ANY PRODUCT OR CIRCUIT DESCRIBED HEREIN; NEITHER DOES IT CONVEY ANY LICENSE UNDER ITS PATENT RIGHTS, NOR THE RIGHTS OF OTHERS.

LIFE SUPPORT POLICY

FAIRCHILD'S PRODUCTS ARE NOT AUTHORIZED FOR USE AS CRITICAL COMPONENTS IN LIFE SUPPORT DEVICES OR SYSTEMS WITHOUT THE EXPRESS WRITTEN APPROVAL OF FAIRCHILD SEMICONDUCTOR CORPORATION. As used herein:

1. Life support devices or systems are devices or systems which, (a) are intended for surgical implant into the body, or (b) support or sustain life, or (c) whose failure to perform when properly used in accordance with instructions for use provided in the labeling, can be reasonably expected to result in significant injury to the user.
2. A critical component is any component of a life support device or system whose failure to perform can be reasonably expected to cause the failure of the life support device or system, or to affect its safety or effectiveness.

PRODUCT STATUS DEFINITIONS

Definition of Terms

| Datasheet Identification | Product Status | Definition |
|--------------------------|------------------------|---|
| Advance Information | Formative or In Design | This datasheet contains the design specifications for product development. Specifications may change in any manner without notice. |
| Preliminary | First Production | This datasheet contains preliminary data, and supplementary data will be published at a later date. Fairchild Semiconductor reserves the right to make changes at any time without notice in order to improve design. |
| No Identification Needed | Full Production | This datasheet contains final specifications. Fairchild Semiconductor reserves the right to make changes at any time without notice in order to improve design. |
| Obsolete | Not In Production | This datasheet contains specifications on a product that has been discontinued by Fairchild semiconductor. The datasheet is printed for reference information only. |