

SURFACE MOUNT GLASS PASSIVATED
SUPER FAST SILICON RECTIFIER
VOLTAGE RANGE 50 to 400 Volts CURRENT 3.0 Amperes

FEATURES

- * Glass passivated device
- * Ideal for surface mounted applications
- * Low leakage current
- * Metallurgically bonded construction
- * Mounting position: Any
- * Weight: 0.24 gram

MECHANICAL DATA

- * Epoxy : Device has UL flammability classification 94V-0



DO-214AB

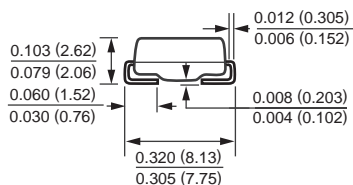
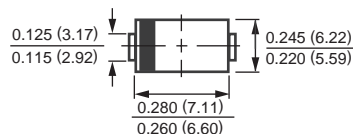

Dimensions in inches and (millimeters)

MAXIMUM RATINGS AND ELECTRICAL CHARACTERISTICS

Ratings at 25 °C ambient temperature unless otherwise specified.
 Single phase, half wave, 60 Hz, resistive or inductive load.
 For capacitive load, derate current by 20%.

MAXIMUM RATINGS (At TA = 25°C unless otherwise noted)

RATINGS	SYMBOL	EFM301	EFM302	EFM303	EFM304	EFM305	EFM306	UNITS	
Maximum Recurrent Peak Reverse Voltage	V _{RRM}	50	100	150	200	300	400	Volts	
Maximum RMS Volts	V _{RMS}	35	70	105	140	210	280	Volts	
Maximum DC Blocking Voltage	V _{DC}	50	100	150	200	300	400	Volts	
Maximum Average Forward Current at TA = 55°C	I _O	3.0							Amps
Peak Forward Surge Current I _{FM} (surge): 8.3 ms single half sine-wave superimposed on rated load (JEDEC method)	I _{FSM}	125							Amps
Typical Junction Capacitance (Note 2)	C _J	50				30		pF	
Operating and Storage Temperature Range	T _J , T _{STG}	-65 to + 175						°C	

ELECTRICAL CHARACTERISTICS (At TA = 25°C unless otherwise noted)

CHARACTERISTICS	SYMBOL	EFM301	EFM302	EFM303	EFM304	EFM305	EFM306	UNITS
Maximum Forward Voltage at 3.0A DC	V _F	0.95			1.25			Volts
Maximum DC Reverse Current at Rated DC Blocking Voltage	I _R	5.0						uAmps
Maximum Reverse Recovery Time (Note 1)	t _{rr}	35						nSec

NOTES : 1. Test Conditions: I_F=0.5A, I_R=-1.0A, I_{RR}=-0.25A.
 2. Measured at 1 MHz and applied reverse voltage of 4.0 volts.

RATING AND CHARACTERISTIC CURVES (EFM301 THRU EFM306)

FIG. 1 - TEST CIRCUIT DIAGRAM AND REVERSE RECOVERY TIME CHARACTERISTIC

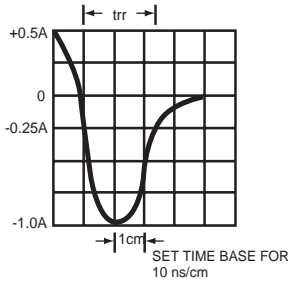
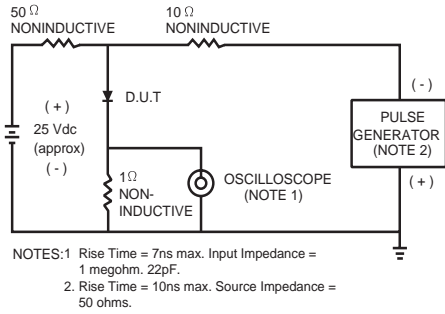

FIG. 2 - TYPICAL FORWARD CURRENT DERATING CURVE

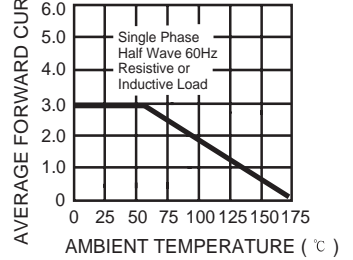

FIG. 3 - TYPICAL REVERSE CHARACTERISTICS

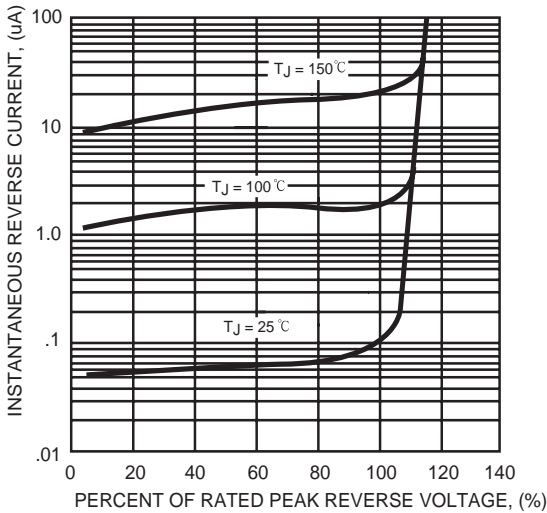

FIG. 4 - TYPICAL INSTANTANEOUS FORWARD CHARACTERISTICS

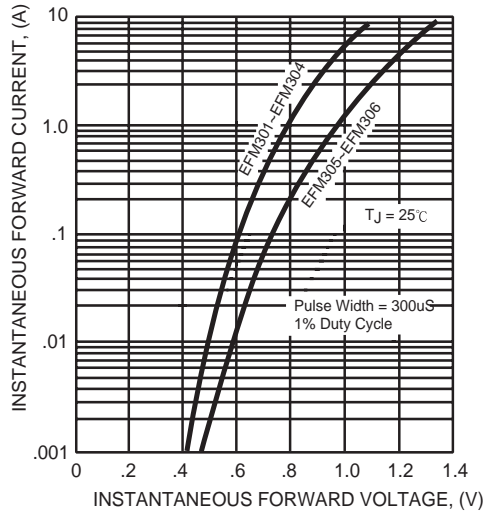

FIG. 5 - MAXIMUM NON-REPETITIVE FORWARD SURGE CURRENT

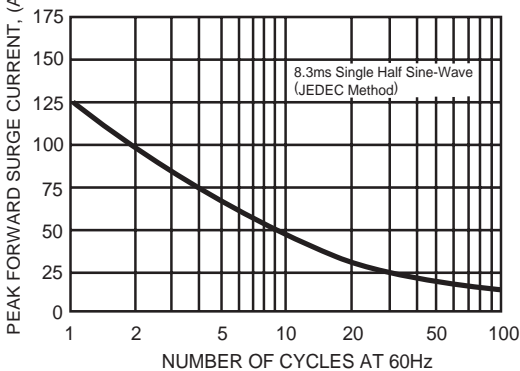

FIG. 6 - TYPICAL JUNCTION CAPACITANCE

