



Design Example Report

| | |
|------------------------|--|
| Title | <i>15W Flyback Power Supply using TOP244P</i> |
| Specification | Input: 90 – 265 VAC 50/60Hz Output: +24 VDC @ 625mA |
| Application | Refrigerator |
| Author | Power Integrations Applications Department |
| Document Number | DER-106 |
| Date | May 19, 2006 |
| Revision | 1.1 |

Summary and Features

- Low part count, Low-cost Isolated Flyback Power Supply
- E-SHIELD® Transformer Construction for reduced common-mode EMI (small 220pF Y1 capacitor and small 10mH Common-mode choke)
- 132kHz Switching Frequency with jitter to reduce conducted EMI
- Auto-restart function for automatic and self-resetting open-loop, overload and short-circuit protection
- Built-in Hysteretic thermal shutdown at 135C
- Enhanced 8-pin DIP package with increased creepage from Drain to low-voltage control pins
- EcoSmart® for extremely low standby power consumption <800 mW at 230 VAC

The products and applications illustrated herein (including circuits external to the products and transformer construction) may be covered by one or more U.S. and foreign patents or potentially by pending U.S. and foreign patent applications assigned to Power Integrations. A complete list of Power Integrations' patents may be found at www.powerint.com.

Table Of Contents

| | | |
|--------|---|----|
| 1 | Introduction | 3 |
| 2 | Power Supply Specification | 4 |
| 3 | Schematic | 5 |
| 4 | Circuit Description | 6 |
| 4.1 | Input EMI Filtering | 6 |
| 4.2 | TOPSwitch Primary | 6 |
| 4.3 | Output Rectification | 6 |
| 4.4 | Output Feedback | 7 |
| 5 | PCB Layout | 8 |
| 6 | Bill Of Materials | 9 |
| 7 | Transformer Specification | 10 |
| 8 | Transformer Spreadsheets | 14 |
| 9 | Performance Data | 17 |
| 9.1 | Efficiency | 17 |
| 9.2 | No-load Input Power | 17 |
| 9.3 | Regulation | 18 |
| 9.3.1 | Load | 18 |
| 9.3.2 | Line | 18 |
| 10 | Waveforms | 19 |
| 10.1 | Drain Voltage and Current, Normal Operation | 19 |
| 10.2 | Output Voltage Start-up Profile | 19 |
| 10.3 | Drain Voltage and Current Start-up Profile | 20 |
| 10.4 | Load Transient Response (75% to 100% Load Step) | 21 |
| 10.5 | Output Ripple Measurements | 22 |
| 10.5.1 | Ripple Measurement Technique | 22 |
| 10.5.2 | Measurement Results | 23 |
| 11 | Control Loop Measurements | 24 |
| 11.1 | 90 VAC Maximum Load | 24 |
| 11.2 | 265 VAC Maximum Load | 25 |
| 12 | Conducted EMI | 26 |
| 13 | Revision History | 27 |

Important Notes:

Although this board is designed to satisfy safety isolation requirements, the engineering prototype has not been agency approved. Therefore, all testing should be performed using an isolated source to provide power to the prototype board.

Design Reports contain a power supply design specification, schematic, bill of materials, and transformer documentation. Performance data and typical operation characteristics are included. Typically only a single prototype has been built.

1 Introduction

This document is an engineering report describing the design of an AC-DC power supply with universal input providing a regulated +24 VDC at 625 mA. The design, rated for 15 W is implemented using a TOP244P device from the *TOPSwitch-GX* IC family and an EEL19 core in a Flyback topology. This power supply is intended to be used in a refrigerator appliance where the maximum ambient temperature can reach 70C.

The document contains the power supply specification, schematic, bill-of-materials, transformer documentation, printed circuit layout, and performance data.

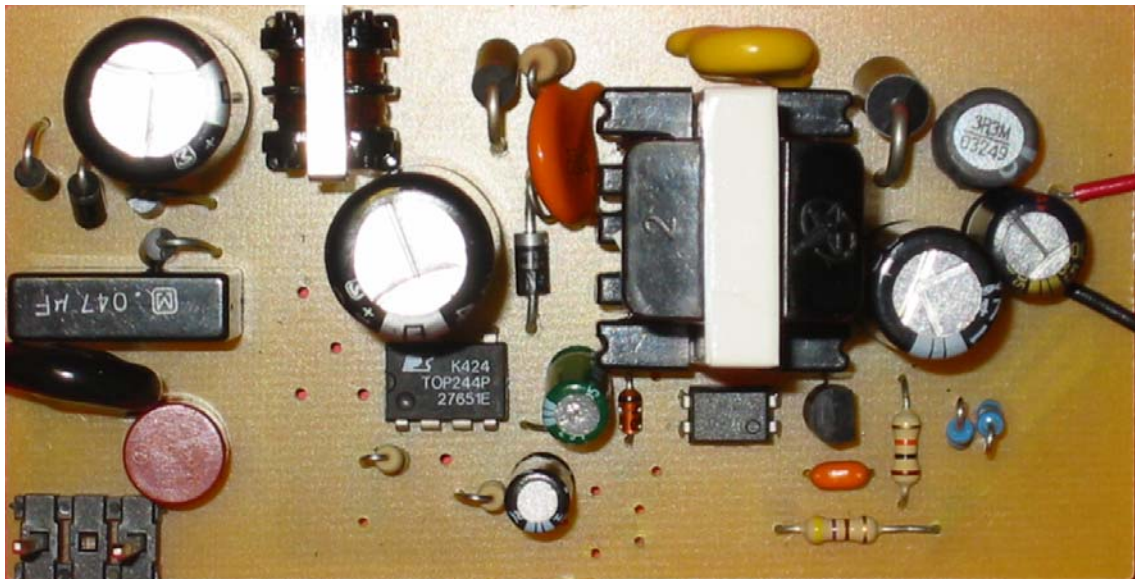

Figure 1 – Populated Circuit Board Photograph

2 Power Supply Specification

| Description | Symbol | Min | Typ | Max | Units | Comment |
|-------------------------------|-----------------|-----|---|-------|-------|---|
| Input | | | | | | |
| Voltage | V_{IN} | 90 | | 265 | VAC | 2 Wire – no P.E. |
| Frequency | f_{LINE} | 47 | 50/60 | 64 | Hz | |
| No-load Input Power (230 VAC) | | | | 0.8 | W | |
| Output | | | | | | |
| Output Voltage 1 | V_{OUT1} | | 24 | | V | ± 5% 20 MHz bandwidth |
| Output Ripple Voltage 1 | $V_{RIPPLE1}$ | | 100 | | mV | |
| Output Current 1 | I_{OUT1} | | | 0.625 | A | |
| Total Output Power | | | | | | |
| Continuous Output Power | P_{OUT} | | | 15 | W | |
| Peak Output Power | P_{OUT_PEAK} | | | 20 | W | |
| Efficiency | η | 82 | | | % | Measured at P_{OUT} (15 W), 25 °C |
| Environmental | | | | | | |
| Conducted EMI | | | Meets CISPR22B / EN55022B | | | 1.2/50 μ s surge, IEC 1000-4-5, Series Impedance: Differential Mode: 2 Ω Common Mode: 12 Ω |
| Safety | | | Designed to meet IEC950, UL1950 Class II | | | |
| Surge | | 4 | | | kV | |
| Surge | | 3 | | | kV | 100 kHz ring wave, 500 A short circuit current, differential and common mode |
| Ambient Temperature | T_{AMB} | 0 | | 70 | °C | Free convection, sea level |

3 Schematic

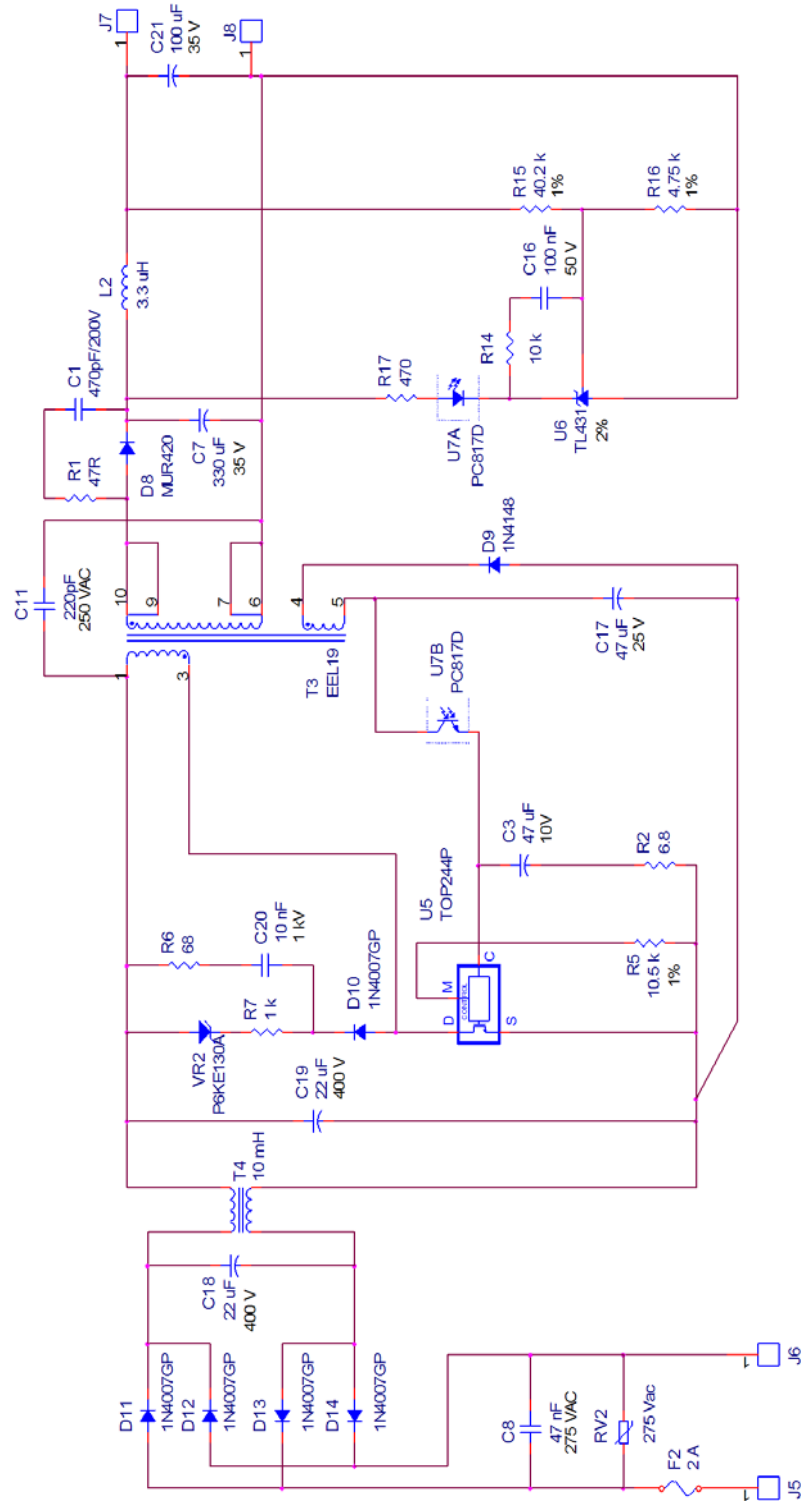

Figure 2 – Schematic

4 Circuit Description

The schematic in Figure 2 shows an off-line Flyback converter using the TOP244P. The circuit is designed for 90 VAC to 265 VAC input and provides a single output; +24 V @ 625 mA.

4.1 Input EMI Filtering

Conducted EMI filtering is provided by C8, C11, C18 and T4. The switching frequency jitter feature of the *TOPSwitch-GX* family allows the use of a small, low cost common mode choke for T4 and reduces the value of C8 and C11 needed to meet EN55022 / CISPR22 Class B with good margin. A safety rated Y capacitor bridges the isolation barrier from the rectified DC rail to output return. This returns common mode EMI currents generated by the primary and secondary switching-waveforms, reducing conducted EMI. EMI results are presented in a later section of this document. Returning the Y capacitor to the DC rail ensures high currents present during line transients are routed away from U1.

4.2 TOPSwitch Primary

To keep the peak DRAIN voltage acceptably below the BV_{DSS} (700 V) of U5, diode D10, R7, VR2, C20, and R6 form a primary clamp. This network clamps the voltage spike seen on the DRAIN due to primary and secondary reflected leakage inductance. Capacitor C20 together with R6 form the main clamp with VR2 providing a hard limit for the maximum voltage seen across the primary. Resistor R7 ensures that VR2 only conducts at the end of the leakage inductance spike event, limiting dissipation. Diode D10 is deliberately selected as a slow recovery type, but must be a glass-passivated type to guarantee the reverse recovery time as defined by the manufacturer. Standard 1N4007 diodes should not be used as their potential for very long reverse recovery times can cause excessive drain ringing. The slow recovery time, compared to fast or ultra-fast diodes, allows recovery of some of the clamp energy, improving efficiency.

The discrete full bridge rectifier bridge comprised of D11-D14 and C18 provide a high voltage DC BUS for the primary circuitry. The DC rail is applied to the primary winding of T5. The other side of the transformer primary is driven by the integrated MOSFET in U5. R5 sets the U5 current limit to approximately 70% of its nominal value. This limits the output power delivered during fault conditions. C3 has 3 functions. It provides the energy required by U5 during startup, sets the auto-restart frequency during fault conditions, and also acts to roll off the gain of U5 as a function of frequency. R2 adds a zero to stabilize the power supply control loop. Diode D9 and C17 provide rectified and filtered bias power for U5 and U7.

4.3 Output Rectification

The output of T5 is rectified and filtered by D8 and C7. Inductor L2 and C21 provide additional high frequency filtering. Resistor R1 and C1 provide snubbing for D8. Choosing the proper snubber values is important for low zero-load power consumption and for high frequency EMI suppression. The snubber components were chosen so that the turn-on

voltage spike at the D8 anode is slightly under-damped. Increasing C1 and reducing R1 will improve damping and high frequency EMI, at the cost of higher zero-load power consumption.

4.4 Output Feedback

Resistors R15 and R16 divide down the supply output voltage and apply it to the reference pin of error amplifier U6. Shunt regulator U6 drives Optocoupler U7 through resistor R17 to provide feedback information to the U1 CONTROL pin. The Optocoupler output also provides power to U5 during normal operating conditions.

Components R2, R17, R14, C3 and C16 all play a role in compensating the power supply control loop. Capacitor C3 rolls off the gain of U1 at relatively low frequency. Resistor R2 provides a zero to cancel the phase shift of C3. Resistor R17 sets the gain of the direct signal path from the supply output through U7 and U6. Components C16 and R14 roll off the gain of the error amplifier (U6).

5 PCB Layout

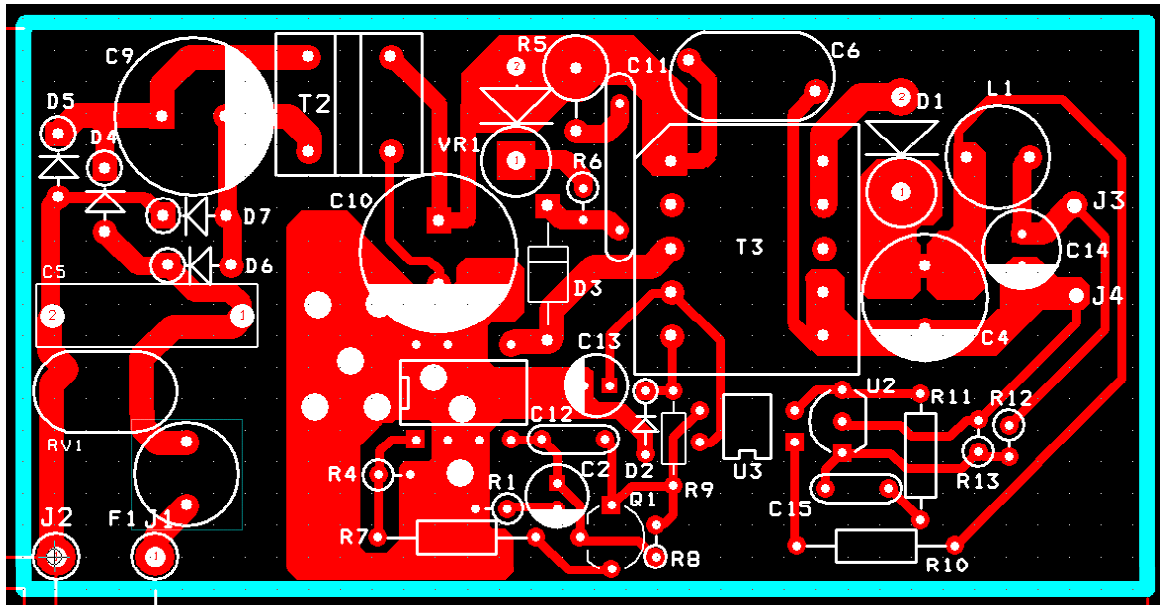

Figure 3 – Printed Circuit Layout

6 Bill of Materials

| Item | QTY | Ref Des | Value | Mfg Part Number | Description |
|------|-----|------------------------|------------|------------------|--|
| 1 | 1 | C1 | 470pF/200V | | 470pF, 200 V, Ceramic, NPO |
| 2 | 2 | C3 C17 | 47uF | LXZ25VB47RME11LL | 47uF, 25 V, Electrolytic, Low ESR, 500mOhm, (5 x 11.5) |
| 3 | 1 | C7 | 330uF | KZE35VB331MJ16LL | 330uF, 35 V, Electrolytic, Very Low ESR, 38mOhm, (10 x 16) |
| 4 | 1 | C8 | 47nF | ECQ-U2A473ML | 47nF, 275 VAC, Film, X2 |
| 5 | 1 | C11 | 220pF | | 220pF, Ceramic, Y1 |
| 6 | 1 | C16 | 100nF | ECU-S1H104KBB | 100nF, 50 V, Ceramic, X7R |
| 7 | 2 | C18 C19 | 22uF | EEU-EB2G220 | 22uF, 400 V, Electrolytic, High Ripple, (12.5 x 25) |
| 8 | 1 | C20 | 10nF | ECK-D3A103KBP | 10nF, 1 kV, Disc Ceramic |
| 9 | 1 | C21 | 100uF | LXZ35VB101M515LL | 100uF, 35 V, Electrolytic, Low ESR, 180mOhm, (6.3 x 15) |
| 10 | 1 | D8 | MUR420 | MUR420 | 200 V, 4 A, Ultrafast Recovery, 25 ns |
| 11 | 1 | D9 | 1N4148 | 1N4148 | 75 V, 300mA, Fast Switching, DO-35 |
| 12 | 5 | D10 D11 D12 D13 D14 | 1N4007GP | 1N4007GP | 1000 V, 1 A, Rectifier, Glass Passivated, 2 us, DO-41 |
| 13 | 1 | F2 | 2 A | 3-721-200-041 | 2 A, 250V, Slow, TR5 |
| 16 | 1 | L2 | 3.3uH | 822LY-3R3M | 3.3uH, 2.66 A |
| 17 | 1 | R1 | 47R | CFR-25JB-47R | 47R, 5%, 1/4 W, Carbon Film |
| 18 | 1 | R2 | 6.8 | CFR-25JB-6R8 | 6.8 R, 5%, 1/4 W, Carbon Film |
| 19 | 1 | R5 | 10.5 k | MFR-25FBB-10K5 | 10.5 k, 1%, 1/4 W, Metal Film |
| 20 | 1 | R6 | 68 | CFR-25JB-68R | 68 R, 5%, 1/4 W, Carbon Film |
| 21 | 1 | R7 | 1 k | CFR-25JB-1K0 | 1 k, 5%, 1/4 W, Carbon Film |
| 22 | 1 | R14 | 10 k | CFR-25JB-10K | 10 k, 5%, 1/4 W, Carbon Film |
| 23 | 1 | R15 | 40.2 k | MFR-25FBB-40K2 | 40.2 k, 1%, 1/4 W, Metal Film |
| 24 | 1 | R16 | 4.75 k | MFR-25FBB-4K75 | 4.75 k, 1%, 1/4 W, Metal Film |
| 25 | 1 | R17 | 470 | CFR-25JB-470R | 470 R, 5%, 1/4 W, Carbon Film |
| 26 | 1 | RV2 | 275Vac | V275LA4 | 275 V, 23 J, 7 mm, RADIAL |
| 27 | 1 | T4 | 10mH | SC-01-E100G | 10mH, 1A, Common Mode Choke |
| 28 | 1 | T5 | EEL19 | YW-379-02B | Bobbin, EEL19, Vertical, In built margins, 10 pins |
| 29 | 1 | U5 | TOP244P | TOP244P | TOPSwitch-GX, TOP244P, DIP-8B |
| 30 | 1 | U6 | TL431 | TL431CLP | 2.495 V Shunt Regulator IC, 2%, 0 to 70C, TO-92 |
| 31 | 2 | U7 | PC817D | ISP817D, PC817X4 | Opto coupler, 35 V, CTR 300-600%, 4-DIP |
| 32 | 1 | VR2 | P6KE130A | P6KE170A | 170 V, 5 W, 5%, TVS, DO204AC (DO-15) |

7 Transformer Specification

Transformer Construction

▼ Electrical Diagram

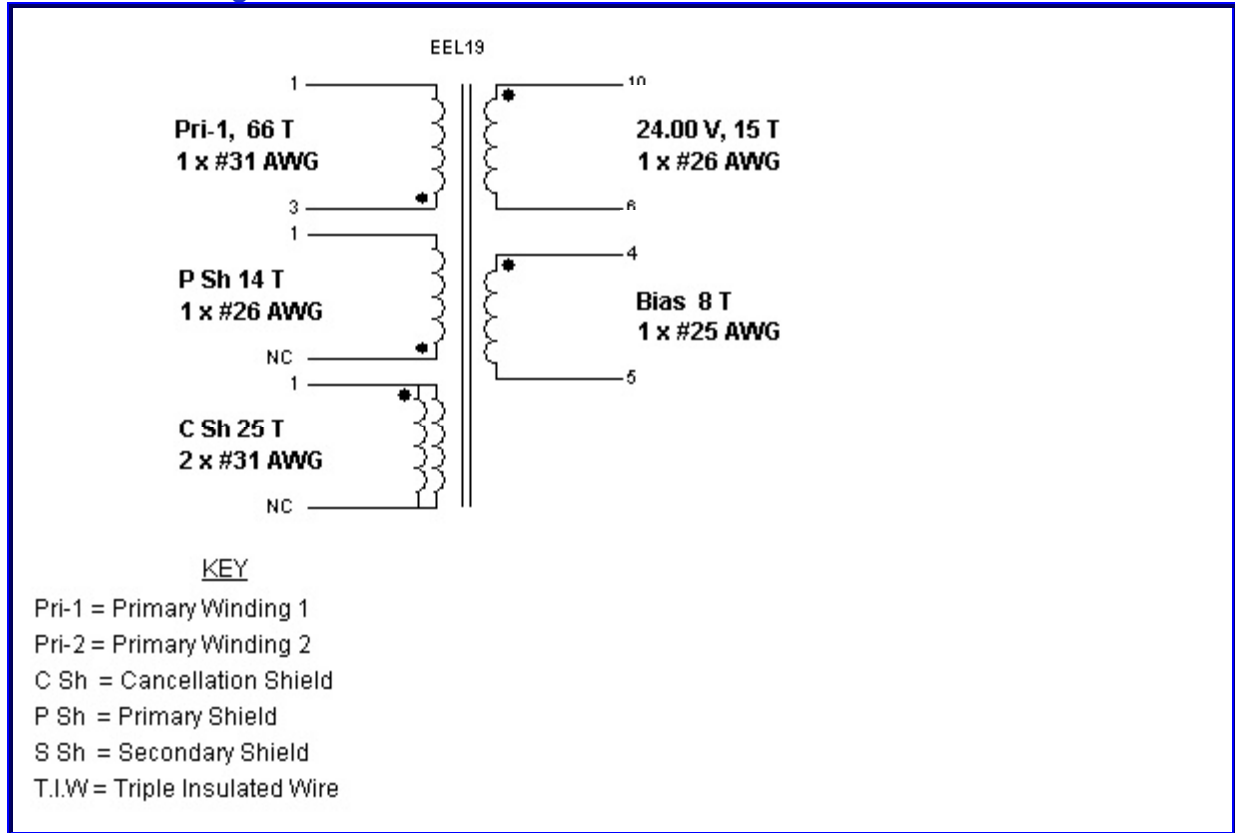

▼ Winding Order

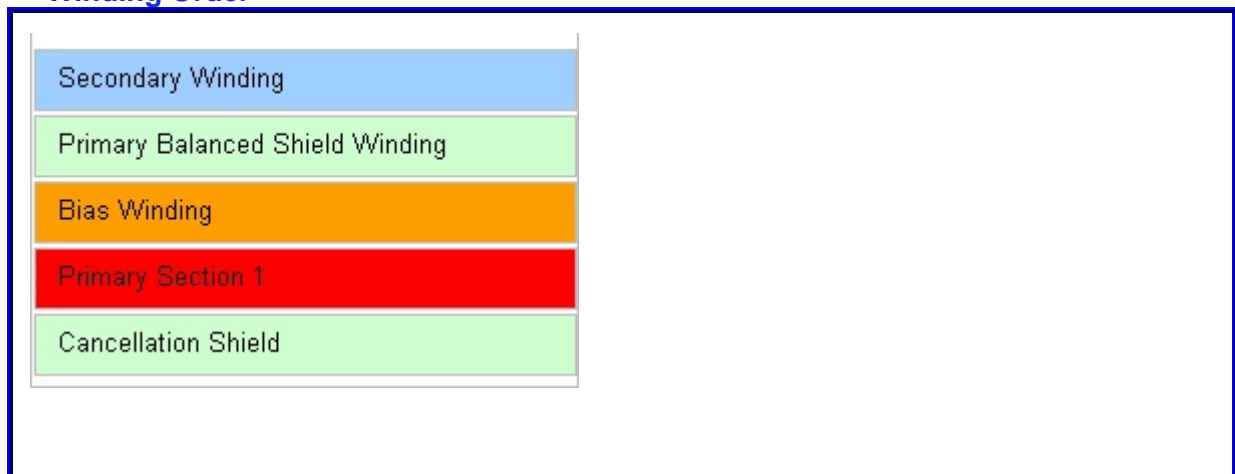

▼ **Core Information**

| | |
|--|----------------------------|
| Core Type | EEL19 |
| Core Material | NC-2H or Equivalent |
| Gap length, mm | 0.109 |
| Gapped Effective Inductance, nH/t ² | 203 |
| Primary Inductance, uH | 884 |

▼ **Bobbin Information**

| | |
|--------------------------|---------------------------------|
| Bobbin Reference | Generic, 5 pri. + 5 sec. |
| Bobbin Orientation | Vertical |
| Number of Primary pins | 5 |
| Number of Secondary pins | 5 |
| Margin on Left, mm | 3.0 |
| Margin on Right, mm | 3.0 |

▼ **Primary Winding**

| <i>Parameter</i> | <i>Section 1</i> |
|--------------------|------------------|
| Number of Turns | 66 |
| Wire Size, AWG | 28 |
| Filar | 1 |
| Layers | 2 |
| Start Pin(s) | 3 |
| Termination Pin(s) | 1 |

▼ **BIAS Winding**

| <i>Parameter</i> | <i>Value</i> |
|--------------------|--------------|
| Number of Turns | 8.0 |
| Wire Size, AWG | 25 |
| Filar | 1 |
| Layers | 0.30 |
| Start Pin(s) | 5 |
| Termination Pin(s) | 4 |

▼ **Shield Information**

| <i>Parameter</i> | <i>Primary</i> | <i>Cancellation</i> |
|--------------------|----------------|---------------------|
| Number of Turns | 14 | 25 |
| Wire Size, AWG | 26 | 31 |
| Filar | 2 | 2 |
| Layers | 1 | 1 |
| Start Pin(s) | NC | 1 |
| Termination Pin(s) | 1 | NC |

▼ **Secondary Winding**

| <i>Parameter</i> | <i>Output 1 (main)</i> |
|-------------------|------------------------|
| Spec Voltage, V | 24.00 |
| Spec Current, A | 0.65 |
| Actual Voltage, V | 24.00 |
| Number of Turns | 15 |
| Wire Size, AWG | 26 T.I.W. |
| Filar | 1 |

| | |
|--------------------|------|
| Filar | 1 |
| Layers | 0.50 |
| Start Pin(s) | 9,10 |
| Termination Pin(s) | 6,7 |

▼ Winding Instruction

Use 3.0 mm margin on the left side. Use 3.0 mm margin on the right side.

Cancellation Shield Winding

Start on pin(s) 1 using item [6] at the start leads and wind 25 turns (x 2 filar) of item [8]. in exactly 1 layer. Leave this end of cancellation shield winding not connected. Bend the end 90 deg and cut the wire in the middle of the bobbin.

Add 1 layer of tape, item [4], to secure the winding in place.

Primary Winding

Start on pin(s) 3 using item [6] at the start leads and wind 66 turns of item [8] in 2.00 layer(s) from left to right. Add 1 layer of tape, item [5], in between each primary winding layer. At the end of 1st layer, continue to wind the next layer from right to left. On the final layer, spread the winding evenly across entire bobbin. Finish winding on pin(s) 1 using item [6] at the finish leads.

Add 1 layer of tape, item [4], for insulation.

Bias Winding

Start on pin(s) 5 using item [6] at the start leads and wind 8.0 turns (x 1 filar) of item [9]. Spread the winding evenly across entire bobbin. Finish on pin(s) 4 using item [6] at the finish leads.

Add 1 layer of tape, item [4], for insulation.

Primary Balanced Shield Winding

Start on any (temp) pin on the secondary side and wind 14 turns (x 2 filar) of item [10]. Spread the winding evenly across entire bobbin. Finish this winding on pin(s) 1 using item [6] at the finish leads.

Cut out wire connected to temp pin on secondary side. Leave this end of primary shield winding not connected. Bend the end 90 deg and cut the wire in the middle of the bobbin.

Add 3 layers of tape, item [4], for insulation.

Secondary Winding

Start on pin(s) 9,10 using item [6] at the start leads and wind 15 turns (x 1 filar) of item [10]. Spread the winding evenly across entire bobbin. Finish on pin(s) 6, 7 using item [6] at the start leads.

Add 2 layers of tape, item [4], for insulation.

Core Assembly

Assemble and secure core halves. Item [1].

Varnish

Dip varnish uniformly in item [7]. Do not vacuum impregnate.

▼ Materials

| <i>Item</i> | <i>Description</i> |
|-------------|---|
| [1] | Core: EEL19, NC-2H or Equivalent, gapped for ALG of 203 nH/t ² |
| [2] | Bobbin: Generic, 5 pri. + 5 sec. |
| [3] | Tape: Polyester web 3.0 mm wide |
| [4] | Barrier Tape: Polyester film 19.70 mm wide |
| [5] | Separation Tape: Polyester film 13.7 mm wide |
| [6] | Teflon Tubing # 22 |
| [7] | Varnish |
| [8] | Magnet Wire: 31 AWG, Solderable Double Coated |
| [9] | Magnet Wire: 25 AWG, Solderable Double Coated |
| [10] | Magnet Wire: 26 AWG, Triple Insulated Wire |

▼ Electrical Test Specifications

| <i>Parameter</i> | <i>Condition</i> | <i>Spec</i> |
|--------------------------|---|----------------|
| Electrical Strength, VAC | 60 Hz 1 minute, from pins 1 - 2 to pins 6 - 10. | 3000 |
| Primary Inductance, uH | Measured between Pin 1 to Pin 2, with all other Windings open. | 884 uH +/- 10% |
| Primary Leakage, uH | Measured between Pin 1 to Pin 2, with all other Windings shorted. | 44 uH (max) |



8 Transformer Spreadsheets

Design Passed (Optimization Done)

Note: For a list of transformer vendors click [here](#)



▼ Power Supply Input

| <i>Var</i> | <i>Value</i> | <i>Output 1 (main)</i> | <i>Units</i> | <i>Description</i> |
|------------|--------------|----------------------------|--------------|------------------------|
| VACMIN | 85 | | Volts | Min Input AC Voltage |
| VACMAX | 265 | | Volts | Max Input AC Voltage |
| FL | 50 | | Hertz | Line Frequency |
| TC | 2.28 | | mSeconds | Diode Conduction Time |
| Z | 0.45 | | | Loss Allocation Factor |
| N | 84.0 | | % | Efficiency Estimate |

▼ Power Supply Outputs

| <i>Var</i> | <i>Value</i> | <i>Output 1 (main)</i> | <i>Units</i> | <i>Description</i> |
|------------|--------------|----------------------------|--------------|--------------------|
| VOx | | 24.00 | Volts | Output Voltage |
| IOx | | 0.65 | Amps | Output Current |
| VB | 12.0 | | Volts | Bias Voltage |
| IB | 0.006 | | Amps | Bias Current |

▼ Device Variables

| <i>Var</i> | <i>Value</i> | <i>Output 1 (main)</i> | <i>Units</i> | <i>Description</i> |
|------------|----------------|----------------------------|--------------|--|
| Device | TOP244P | | | PI Device Name |
| PO | 15.7 | | Watts | Total Output Power |
| VDRAIN | 626 | | Volts | Maximum Drain Voltage |
| VDS | 3.14 | | Volts | Drain to Source Voltage |
| FS | 132000 | | Hertz | Switching Frequency |
| KRPKDP | 0.70 | | | Continuous/Discontinuous Operating Ratio |
| KI | 0.72 | | | KI Factor |
| ILIMITEXT | 0.67 | | Amps | Device Current Limit External Minimum |
| ILIMITMIN | 0.93 | | Amps | Current Limit Minimum |
| ILIMITMAX | 1.07 | | Amps | Current Limit Maximum |
| IP | 0.57 | | Amps | Peak Primary Current |
| IRMS | 0.29 | | Amps | Primary RMS Current |
| DMAX | 0.56 | | | Maximum Duty Cycle |

▼ Power Supply Components Selection

| <i>Var</i> | <i>Value</i> | <i>Output 1 (main)</i> | <i>Units</i> | <i>Description</i> |
|------------|--------------|----------------------------|--------------|--------------------------|
| CIN | 47.0 | | uFarads | Input Capacitance |
| VMIN | 91.2 | | Volts | Minimum DC Input Voltage |
| VMAX | 374.8 | | Volts | Maximum DC Input Voltage |
| VCLO | 170 | | Volts | Clamp Zener Voltage |

| | | | |
|------------|---------------|-------|---|
| PZ | 1.1 | Watts | Primary Zener Clamp Loss |
| VDB | 0.70 | Volts | Bias Diode Forward Voltage Drop |
| PIVB | 55 | Volts | Bias Rectifier Max Peak Inverse Voltage |
| RLS1 | 2.0 | MOhms | Line sense resistor |
| VUVON_MIN | 90.57 | Volts | Minimum undervoltage threshold beyond which Power supply will start-up |
| VUVON_MAX | 110.59 | Volts | Maximum undervoltage threshold before which Power Supply will start-up |
| VOVOFF_MIN | 422.86 | Volts | Minimum overvoltage threshold after which Power Supply will turn off after an over voltage condition |
| VOVOFF_MAX | 482.91 | Volts | Maximum overvoltage threshold before the Power Supply will turn off after an over voltage condition Comment: Drain voltage close to BVDSS at maximum OV threshold Tip: Verify BVDSS during line surge, decrease VUVON_MAX or reduce VOR. |

▼ Power Supply Output Parameters

| <i>Var</i> | <i>Value</i> | <i>Output 1 (main)</i> | <i>Units</i> | <i>Description</i> |
|------------|--------------|------------------------|---|--------------------|
| VDx | 1.00 | Volts | Output Winding Diode Forward Voltage Drop | |
| PIVSx | 109 | Volts | Output Rectifier Maximum Peak Inverse Voltage | |
| ISPx | 2.41 | Amps | Peak Secondary Current | |
| ISRMSx | 1.09 | Amps | Secondary RMS Current | |
| IRIPPLEx | 0.88 | Amps | Output Capacitor RMS Ripple Current | |

▼ Transformer Construction Parameters

| <i>Var</i> | <i>Value</i> | <i>Output 1 (main)</i> | <i>Units</i> | <i>Description</i> |
|-------------------------|----------------|------------------------|-------------------|---------------------------------|
| Core/Bobbin | EEL19 | | | Core Type |
| Core Manuf. | Generic | | | Core Manufacturer |
| Bobbin Manuf | Generic | | | Bobbin Manufacturer |
| LP | 884 | | uHenries | Primary Inductance |
| NP | 66.0 | | | Primary Number of Turns |
| NB | 7.6 | | | Bias Winding Number of Turns |
| OD Actual | 0.23 | | mm | Primary Actual Wire Diameter |
| Primary Current Density | 7 | | A/mm ² | Primary Winding Current Density |
| VOR | 110.00 | | Volts | Reflected Output Voltage |
| BW | 19.70 | | mm | Bobbin Winding Width |
| M | 3.0 | | mm | Safety Margin Width |
| L | 1.40 | | | Primary Number of Layers |
| AE | 24.50 | | mm ² | Core Cross Sectional Area |



| | | | |
|------|-------------|-------------------|----------------------------------|
| ALG | 203 | nH/T ² | Gapped Core Effective Inductance |
| BM | 310 | milliTesla | Maximum Flux Density |
| BP | 419 | milliTesla | Peak Flux density |
| BAC | 108 | milliTesla | AC Flux Density for Core Loss |
| LG | 0.11 | mm | Gap Length |
| LL | 17.7 | uHenries | Primary Leakage Inductance |
| LSEC | 30 | nHenries | Secondary Trace Inductance |

▼ **Secondary Parameters**

| Var | Value | Output 1 (main) | Units | Description |
|---------------------|--------------|----------------------------|--------------|--|
| NSx | | 15.0 | | Secondary Number of Turns |
| Rounded Down NSx | | | | Rounded to Integer Secondary Number of Turns |
| Rounded Down Vox | | | Volts | Auxiliary Output Voltage for Rounded down to Integer Secondary Number of Turns |
| Rounded Up NSx | | | | Rounded to Next Integer Secondary Number of Turns |
| Rounded Up Vox | | | Volts | Auxiliary Output Voltage for Rounded up to Next Integer Secondary Number of Turns |
| ODS Actual Range | | 0.36 - 0.57 | mm | Secondary Actual Wire Diameter Range Comment: Secondary wire size is greater than recommended maximum (0.4 mm) Tip: Consider a parallel winding technique (bifilar, trifilar) for >1.5 A outputs, increase size of transformer (larger BW), reduce margin (M). |

9 Performance Data

All measurements performed at room temperature, 60 Hz input frequency.

9.1 Efficiency

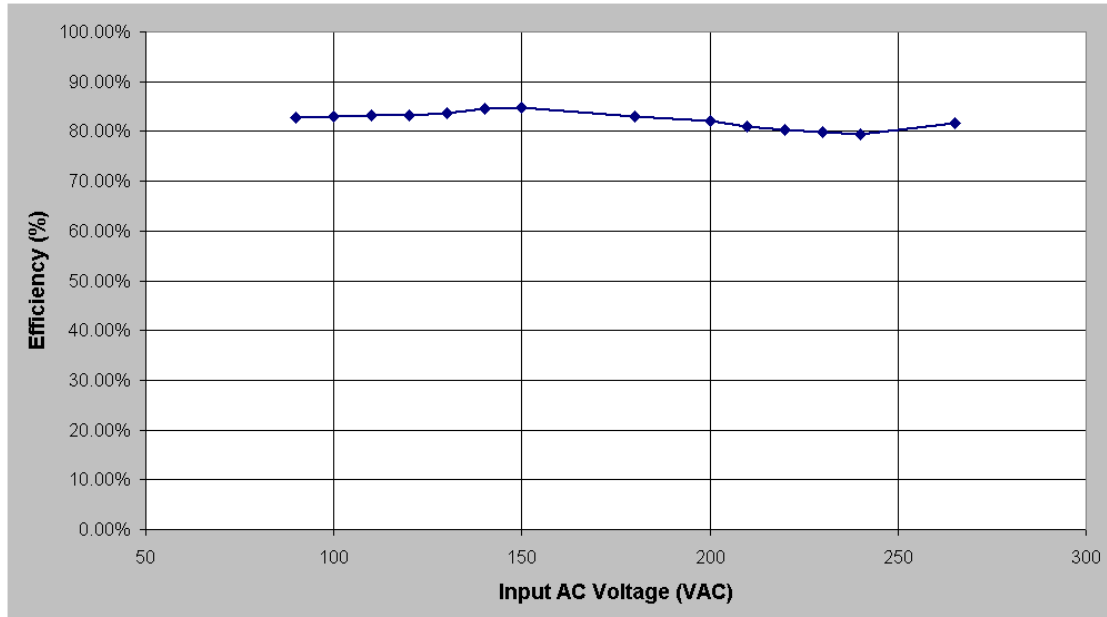

Figure 4 – Efficiency vs. Input Voltage, Room Temperature, 60 Hz.

9.2 No-load Input Power

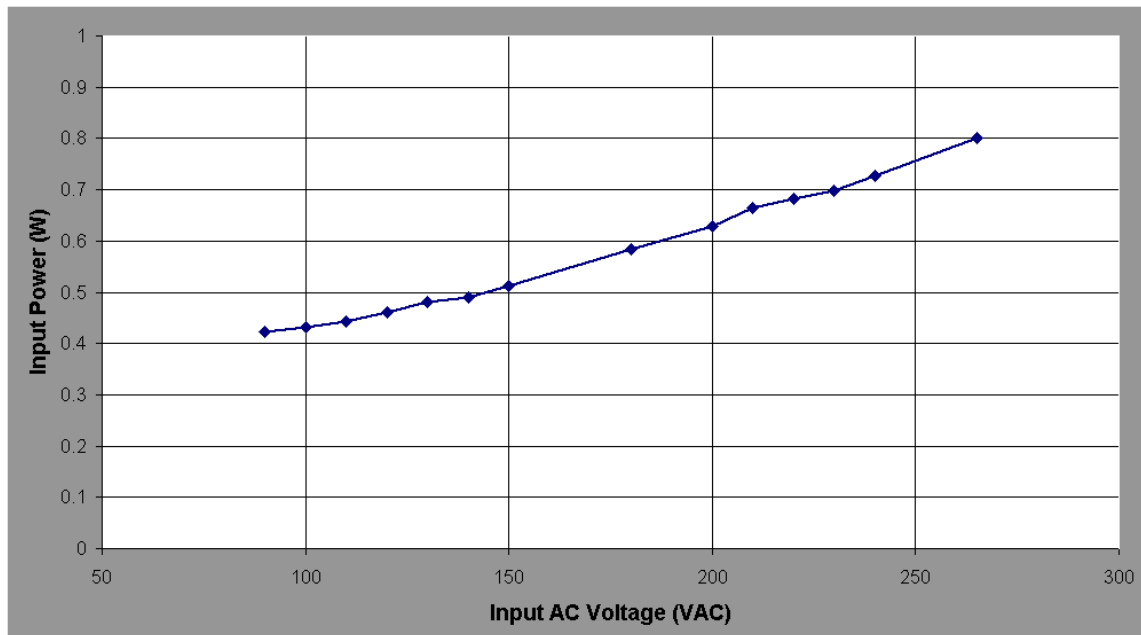

Figure 5 – Zero Load Input Power vs. Input Line Voltage, Room Temperature, 60 Hz.

9.3 Regulation

9.3.1 Load

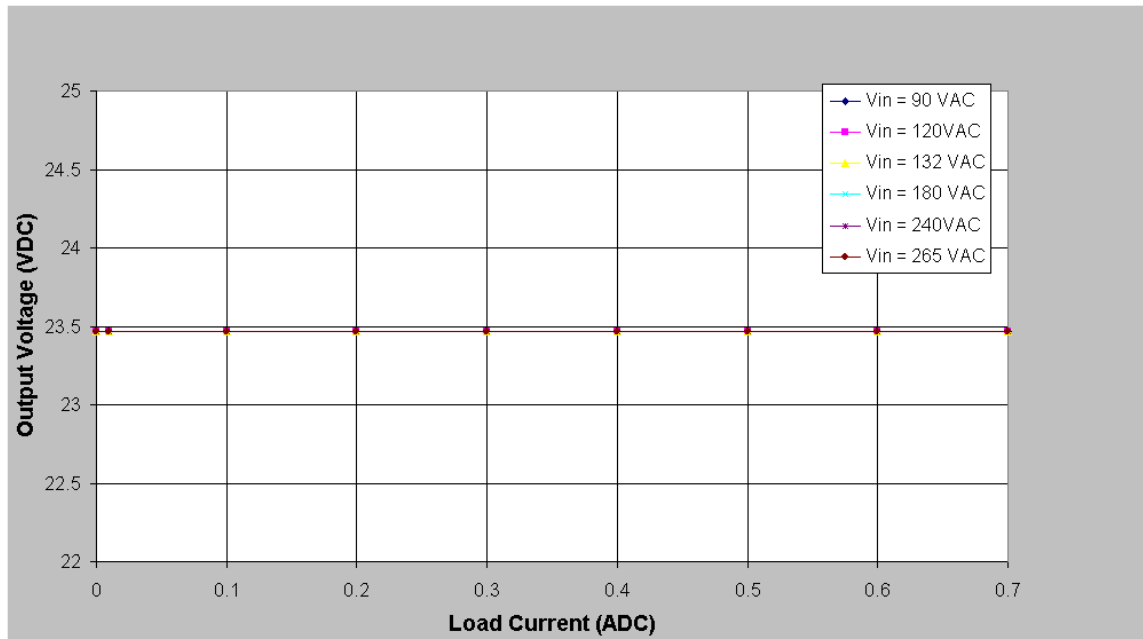

Figure 6 – Load Regulation, Room Temperature

9.3.2 Line

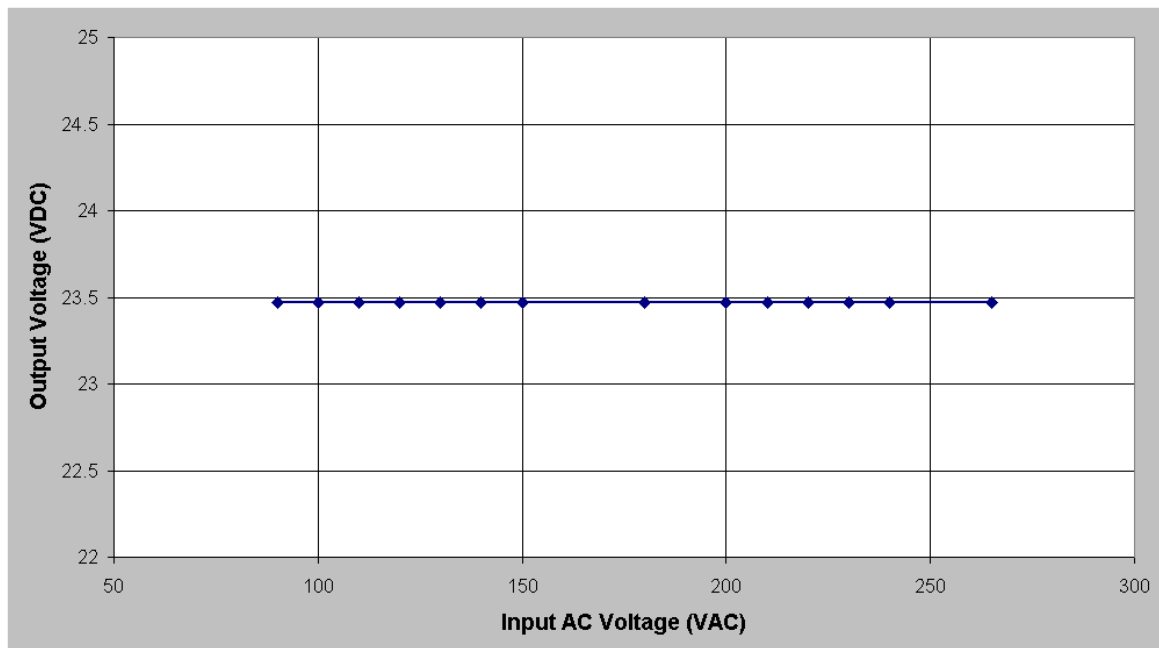

Figure 7 – Line Regulation, Room Temperature, Full Load

10 Waveforms

10.1 Drain Voltage and Current, Normal Operation

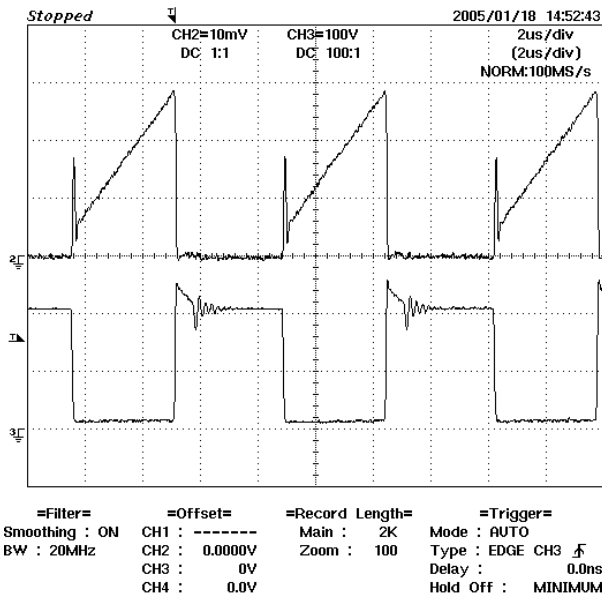

Figure 8 – 90 VAC, Full Load.
Upper: I_{DRAIN} , 0.2 A / div
Lower: V_{DRAIN} , 100 V, 2 μ s / div

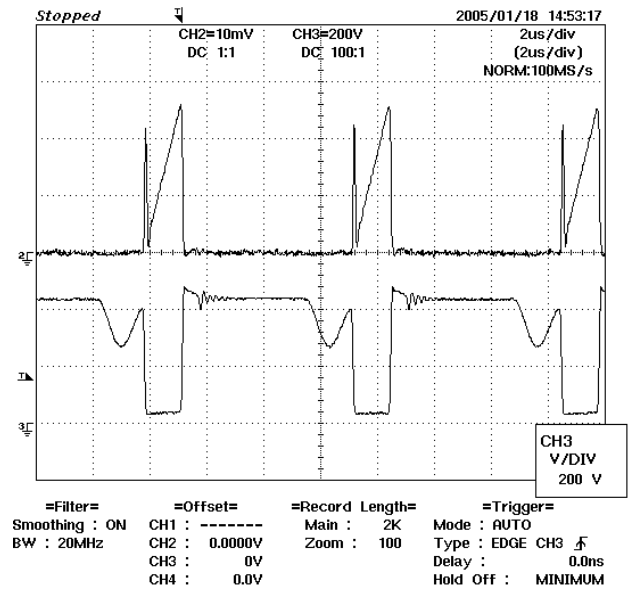

Figure 9 – 265 VAC, Full Load
Upper: I_{DRAIN} , 0.2 A / div
Lower: V_{DRAIN} , 200 V / div

10.2 Output Voltage Start-up Profile

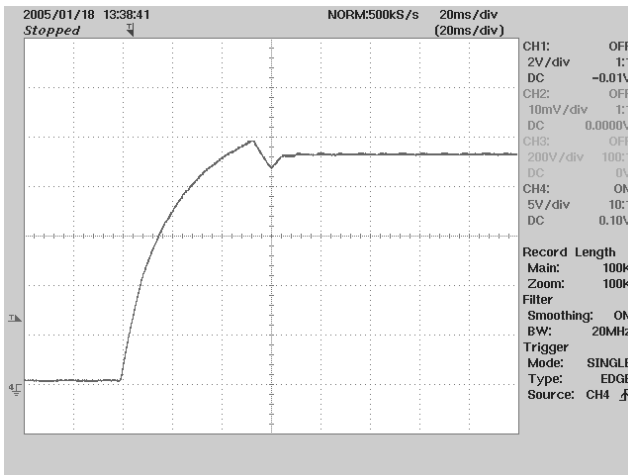

Figure 10 – Start-up Profile, 120 VAC
2 V, 20 ms / div.

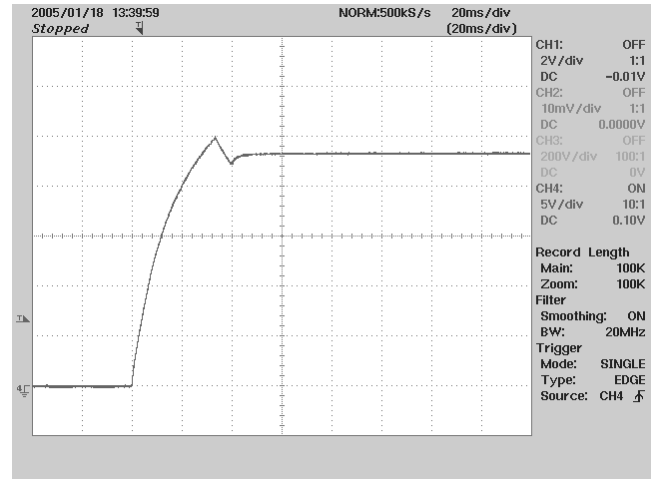
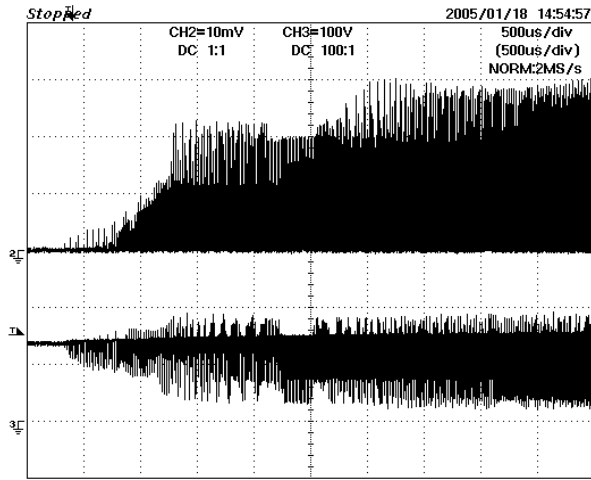

Figure 11 – Start-up Profile, 240 VAC
2 V, 20 ms / div.

10.3 Drain Voltage and Current Start-up Profile



=Filter= =Offset= =Record Length= =Trigger=
 Smoothing : ON CH1 : ----- Main : 10K Mode : SGL(S)
 BW : 20MHz CH2 : 0.0000V Zoom : 400 Type : EDGE CH3 ⌵
 CH3 : 0V Delay : 0.0ns
 CH4 : 0.0V Hold Off : MINIMUM

Figure 12 – 90 VAC Input and Maximum Load.
 Upper: I_{DRAIN} , 0.5 A / div.
 Lower: V_{DRAIN} , 100 V & 1 ms / div.

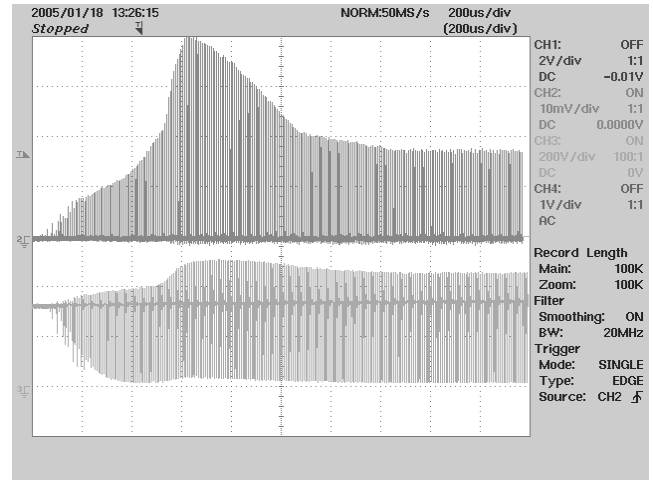

Figure 13 – 265 VAC Input and Maximum Load.
 Upper: I_{DRAIN} , 0.5 A / div.
 Lower: V_{DRAIN} , 200 V & 1 ms / div.

10.4 Load Transient Response (75% to 100% Load Step)

In the figures shown below, signal averaging was used to better enable viewing the load transient response. The oscilloscope was triggered using the load current step as a trigger source. Since the output switching and line frequency occur essentially at random with respect to the load transient, contributions to the output ripple from these sources will average out, leaving the contribution only from the load step response.

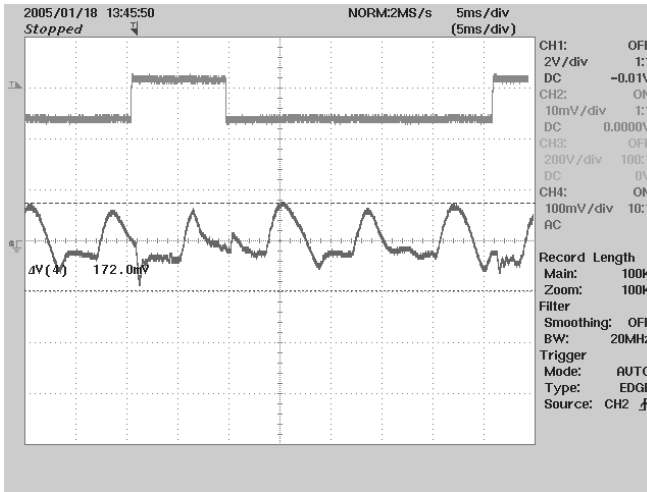

Figure 14 – Transient Response, 120 VAC, 75-100-75% Load Step.
Top: Load Current, 0.5 A/div.
Bottom: Output Voltage
100 mV, 5msec / div.

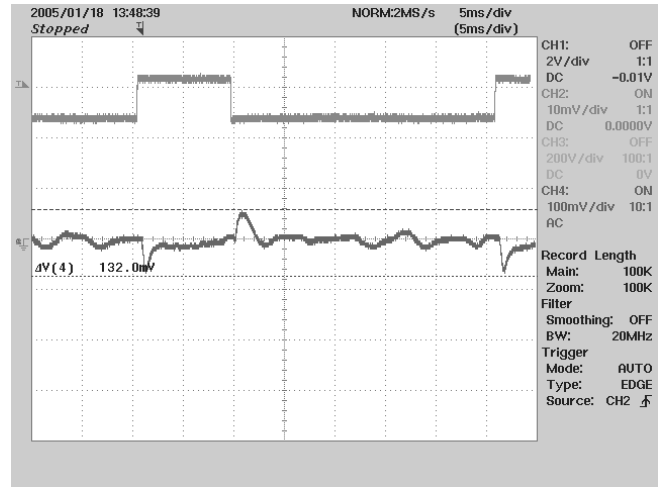

Figure 15 – Transient Response, 240 VAC, 75-100-75% Load Step
Upper: Load Current, 0.5 A/ div.
Bottom: Output Voltage
100 mV, 5 ms / div.

10.5 Output Ripple Measurements

10.5.1 Ripple Measurement Technique

For DC output ripple measurements, a modified oscilloscope test probe must be utilized in order to reduce spurious signals due to pickup. Details of the probe modification are provided in Figure 16 and Figure 17.

The 5125BA probe adapter is affixed with two capacitors tied in parallel across the probe tip. The capacitors include one (1) 0.1 $\mu\text{F}/50\text{ V}$ ceramic type and one (1) 1.0 $\mu\text{F}/50\text{ V}$ aluminum electrolytic. **The aluminum electrolytic type capacitor is polarized, so proper polarity across DC outputs must be maintained (see below).**

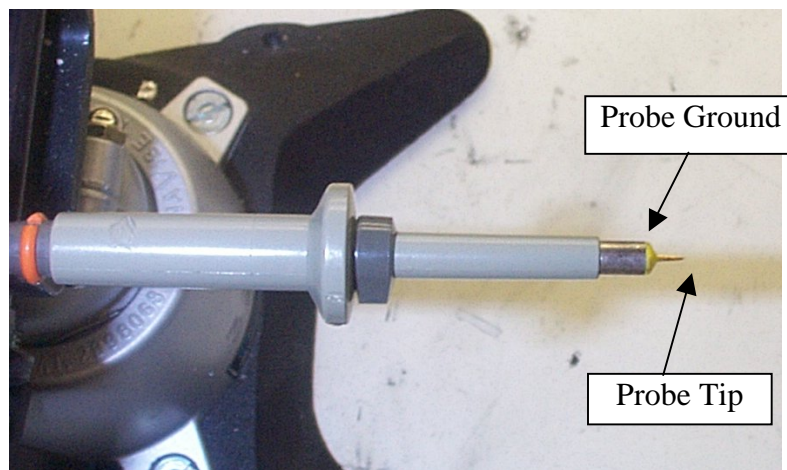

Figure 16 – Oscilloscope Probe Prepared for Ripple Measurement. (End Cap and Ground Lead Removed)



Figure 17 – Oscilloscope Probe with Probe Master 5125BA BNC Adapter. (Modified with wires for probe ground for ripple measurement, and two parallel decoupling capacitors added)

10.5.2 Measurement Results

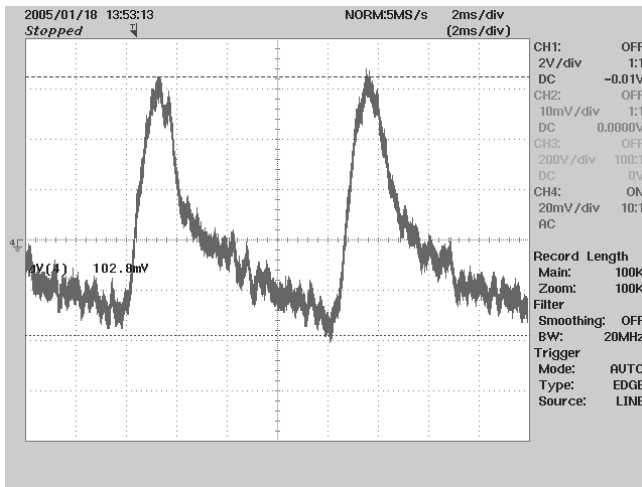

Figure 18 – +24 V Ripple, 90 VAC, Full Load.
2 ms, 20 mV / div

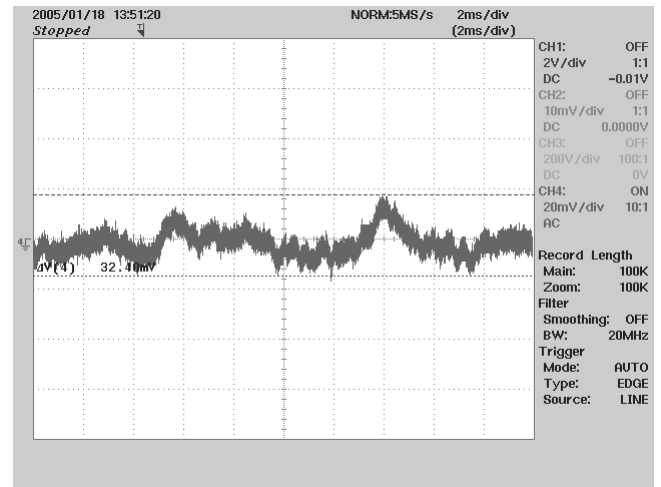

Figure 19 – +24 V Ripple, 265 VAC, Full Load.
2 ms, 20 mV / div

11 Control Loop Measurements

11.1 90 VAC Maximum Load

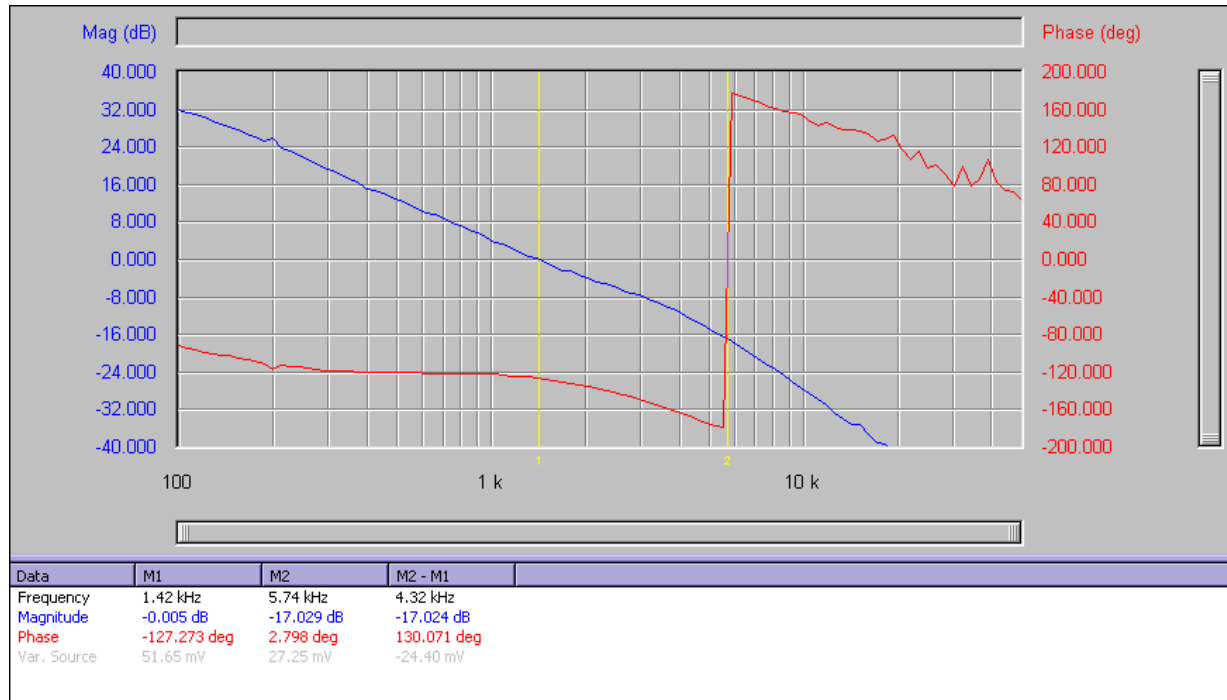

Figure 20 – Gain-Phase Plot, 90 VAC, Maximum Steady State Load
 Vertical Scale: Gain = 8 dB/div, Phase = 40 °/div.
 Crossover Frequency = 1.42 kHz Phase Margin = 52.7°

11.2 265 VAC Maximum Load

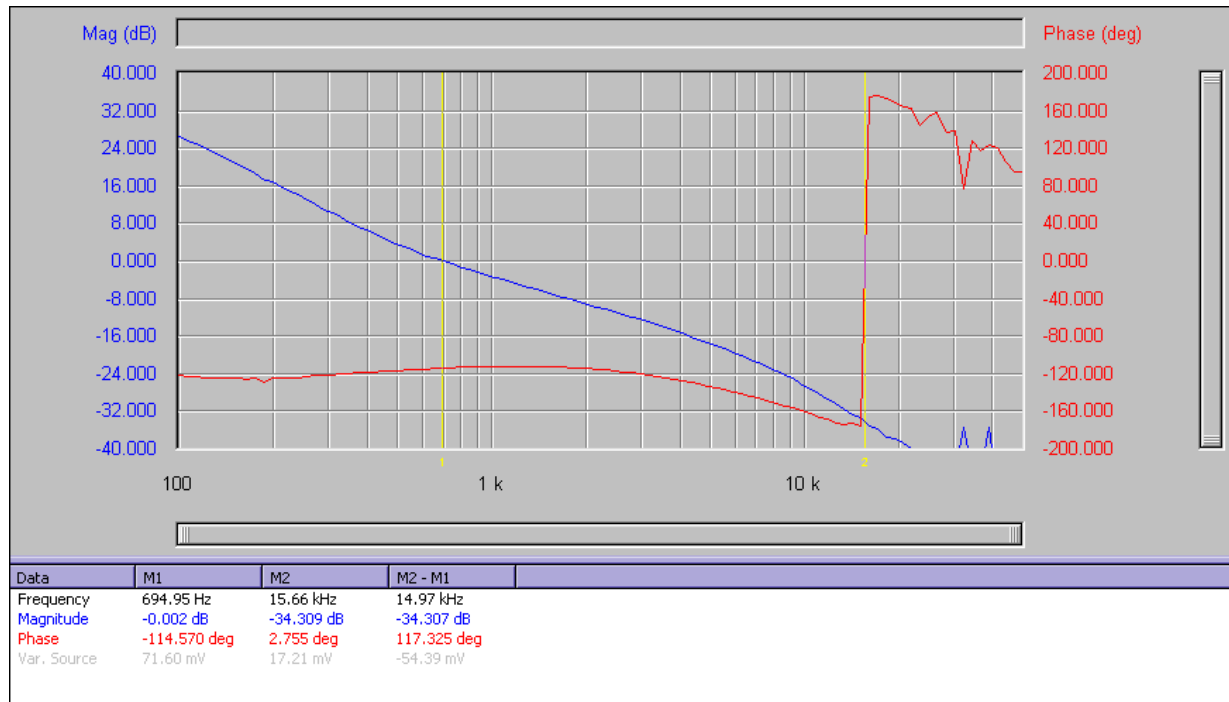

Figure 21 – Gain-Phase Plot, 265 VAC, Maximum Steady State Load
 Vertical Scale: Gain = 8 dB/div, Phase = 40 °/div.
 Crossover Frequency = 695Hz, Phase Margin = 65.4°

12 Conducted EMI

A conducted EMI scan of the prototype was taken to determine the effectiveness of the input filter and transformer ESHIELD® construction. The following plots show the peak performance of the converter against quasi-peak (QP) and average (AVG) limits of EN55022 Class B. Both scans were taken at 120 VAC / 60Hz input with maximum load applied to the outputs. Since the peak scans are below the average limits, it is expected that the QP and Average scans would have greater than 5db of margin below the limits.

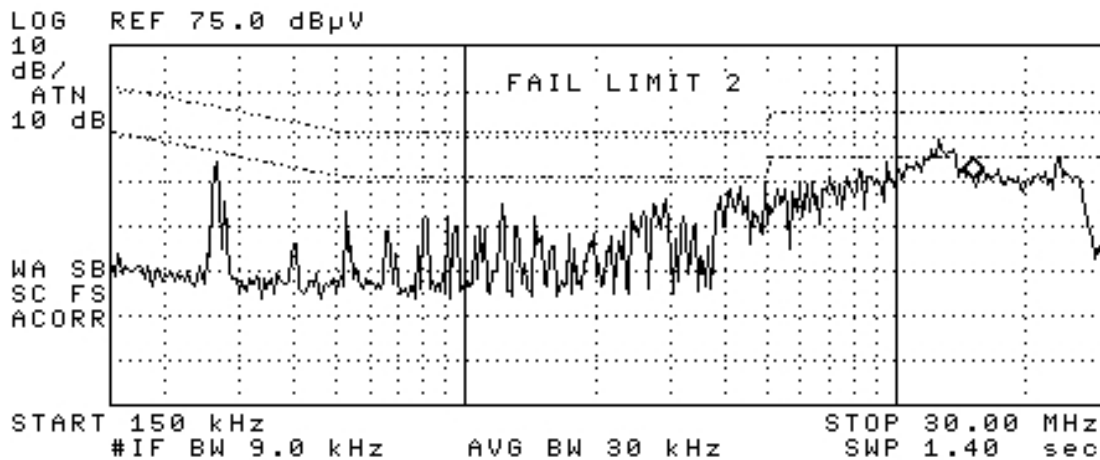

Figure 22 – Conducted EMI (Neutral), Maximum Load, 120 VAC, 60 Hz, and EN55022 B Limits

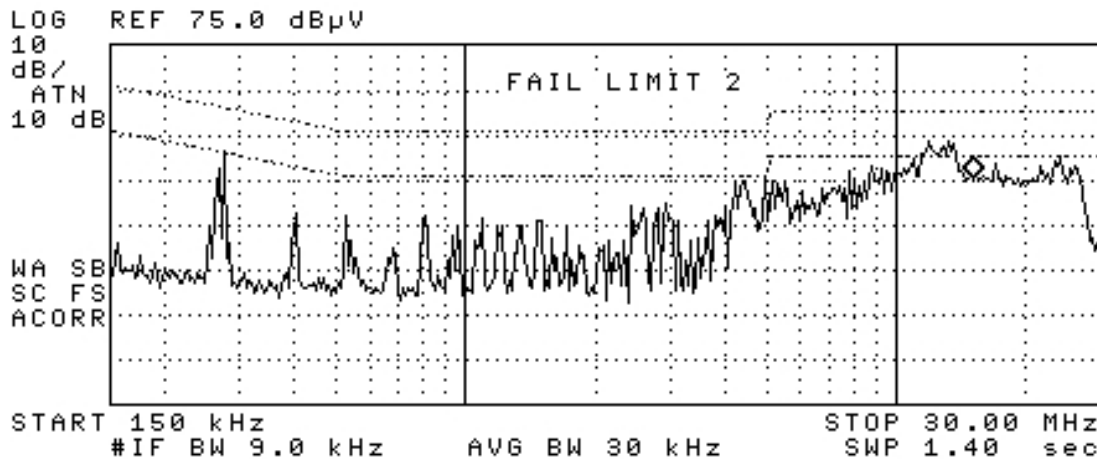

Figure 23 – Conducted EMI (Line), Maximum Load, 120 VAC, 60 Hz, and EN55022 B Limits

13 Revision History

| Date | Author | Revision | Description & changes | Reviewed |
|-------------|---------------|-----------------|----------------------------------|-----------------|
| 10-26-05 | RSP | 1.0 | Initial Release | KM/JC/VC |
| 05-19-06 | RSP | 1.1 | Corrected Schematic | |

For the latest updates, visit our website: www.powerint.com

Power Integrations reserves the right to make changes to its products at any time to improve reliability or manufacturability. Power Integrations does not assume any liability arising from the use of any device or circuit described herein. POWER INTEGRATIONS MAKES NO WARRANTY HEREIN AND SPECIFICALLY DISCLAIMS ALL WARRANTIES INCLUDING, WITHOUT LIMITATION, THE IMPLIED WARRANTIES OF MERCHANTABILITY, FITNESS FOR A PARTICULAR PURPOSE, AND NON-INFRINGEMENT OF THIRD PARTY RIGHTS.

PATENT INFORMATION

The products and applications illustrated herein (including transformer construction and circuits external to the products) may be covered by one or more U.S. and foreign patents, or potentially by pending U.S. and foreign patent applications assigned to Power Integrations. A complete list of Power Integrations' patents may be found at www.powerint.com. Power Integrations grants its customers a license under certain patent rights as set forth at <http://www.powerint.com/ip.htm>.

The PI Logo, **TOPSwitch**, **TinySwitch**, **LinkSwitch**, **DPA-Switch**, **EcoSmart**, **PI Expert** and **PI FACTS** are trademarks of Power Integrations, Inc. Other trademarks are property of their respective companies. ©Copyright 2005 Power Integrations, Inc.

Power Integrations Worldwide Sales Support Locations

WORLD HEADQUARTERS

5245 Hellyer Avenue
San Jose, CA 95138, USA.
Main: +1-408-414-9200
Customer Service:
Phone: +1-408-414-9665
Fax: +1-408-414-9765
e-mail: usasales@powerint.com

GERMANY

Rueckertstrasse 3
D-80336, Munich
Germany
Phone: +49-89-5527-3910
Fax: +49-89-5527-3920
e-mail: eurosales@powerint.com

JAPAN

Keihin Tatemono 1st Bldg
2-12-20
Shin-Yokohama, Kohoku-ku,
Yokohama-shi, Kanagawa ken,
Japan 222-0033
Phone: +81-45-471-1021
Fax: +81-45-471-3717
e-mail: japansales@powerint.com

TAIWAN

5F, No. 318, Nei Hu Rd., Sec. 1
Nei Hu Dist.
Taipei, Taiwan 114, R.O.C.
Phone: +886-2-2659-4570
Fax: +886-2-2659-4550
e-mail: taiwansales@powerint.com

CHINA (SHANGHAI)

Rm 807-808A,
Pacheer Commercial Centre,
555 Nanjing Rd. West
Shanghai, P.R.C. 200041
Phone: +86-21-6215-5548
Fax: +86-21-6215-2468
e-mail: chinasales@powerint.com

INDIA

261/A, Ground Floor
7th Main, 17th Cross,
Sadashivanagar
Bangalore, India 560080
Phone: +91-80-5113-8020
Fax: +91-80-5113-8023
e-mail: indiasales@powerint.com

KOREA

RM 602, 6FL
Korea City Air Terminal B/D,
159-6
Samsung-Dong, Kangnam-Gu,
Seoul, 135-728, Korea
Phone: +82-2-2016-6610
Fax: +82-2-2016-6630
e-mail: koreasales@powerint.com

EUROPE HQ

1st Floor, St. James's House
East Street, Farnham
Surrey, GU9 7TJ
United Kingdom
Phone: +44 (0) 1252-730-140
Fax: +44 (0) 1252-727-689
e-mail: eurosales@powerint.com

CHINA (SHENZHEN)

Room 2206-2207, Block A,
Elec. Sci. Tech. Bldg.
2070 Shennan Zhong Rd.
Shenzhen, Guangdong,
China, 518031
Phone: +86-755-8379-3243
Fax: +86-755-8379-5828
e-mail: chinasales@powerint.com

ITALY

Via Vittorio Veneto 12
20091 Bresso MI
Italy
Phone: +39-028-928-6000
Fax: +39-028-928-6009
e-mail: eurosales@powerint.com

SINGAPORE

51 Newton Road,
#15-08/10 Goldhill Plaza,
Singapore, 308900
Phone: +65-6358-2160
Fax: +65-6358-2015
e-mail: singaporesales@powerint.com

APPLICATIONS HOTLINE

World Wide +1-408-414-9660

APPLICATIONS FAX

World Wide +1-408-414-9760

