

CR6CM

MEDIUM POWER USE
NON-INSULATED TYPE, GLASS PASSIVATION TYPE

CR6CM

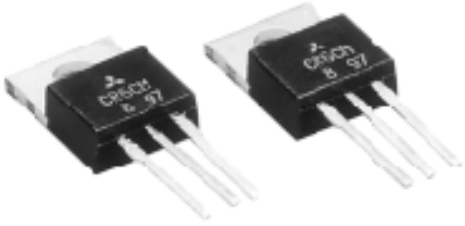

- I_T (AV) 6A
- V_{DRM} 400V/600V
- I_{GT} 10mA

OUTLINE DRAWING

Dimensions in mm

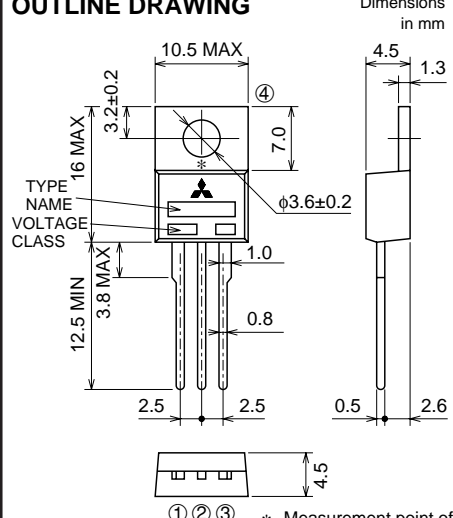

TYPE NAME
VOLTAGE CLASS

① ② ③ * Measurement point of case temperature

① CATHODE
② ANODE
③ GATE
④ ANODE

TO-220

APPLICATION

Switching mode power supply, ECR, regulator for auticycle, motor control

MAXIMUM RATINGS

Symbol	Parameter	Voltage class		Unit
		8	12	
VRRM	Repetitive peak reverse voltage	400	600	V
VRSM	Non-repetitive peak reverse voltage	500	720	V
VR (DC)	DC reverse voltage	320	480	V
VDRM	Repetitive peak off-state voltage	400	600	V
VD (DC)	DC off-state voltage	320	480	V

Symbol	Parameter	Conditions	Ratings	Unit
I_T (RMS)	RMS on-state current		9.4	A
I_T (AV)	Average on-state current	Commercial frequency, sine half wave, 180° conduction, $T_c=88^\circ\text{C}$	6	A
I_{TSM}	Surge on-state current	60Hz sine half wave 1 full cycle, peak value, non-repetitive	90	A
I^2_t	I^2_t for fusing	Value corresponding to 1 cycle of half wave 60Hz, surge on-state current	34	A ² s
PGM	Peak gate power dissipation		5	W
PG (AV)	Average gate power dissipation		0.5	W
VFGM	Peak gate forward voltage		6	V
VRGM	Peak gate reverse voltage		10	V
IFGM	Peak gate forward current		2	A
T_j	Junction temperature		-40 ~ +125	°C
T_{stg}	Storage temperature		-40 ~ +125	°C
—	Weight	Typical value	2.0	g

ELECTRICAL CHARACTERISTICS

Symbol	Parameter	Test conditions	Limits			Unit
			Min.	Typ.	Max.	
IRRM	Repetitive peak reverse current	$T_j=125^{\circ}\text{C}$, V_{RRM} applied	—	—	2.0	mA
IDRM	Repetitive peak off-state current	$T_j=125^{\circ}\text{C}$, V_{DRM} applied	—	—	2.0	mA
V _{TM}	On-state voltage	$T_c=25^{\circ}\text{C}$, $I_{TM}=20\text{A}$, instantaneous value	—	—	1.7	V
V _{GT}	Gate trigger voltage	$T_j=25^{\circ}\text{C}$, $V_D=6\text{V}$, $I_T=1\text{A}$	—	—	1.0	V
V _{GD}	Gate non-trigger voltage	$T_j=125^{\circ}\text{C}$, $V_D=1/2V_{DRM}$	0.2	—	—	V
I _{GT}	Gate trigger current	$T_j=25^{\circ}\text{C}$, $V_D=6\text{V}$, $I_T=1\text{A}$	—	—	10	mA
I _H	Holding current	$T_j=25^{\circ}\text{C}$, $V_D=12\text{V}$	—	15	—	mA
R _{th(j-c)}	Thermal resistance	Junction to case *1	—	—	3.0	$^{\circ}\text{C}/\text{W}$

*1. The contact thermal resistance R_{th(j-c)} is 1.0 $^{\circ}\text{C}/\text{W}$ with greased.

PERFORMANCE CURVES

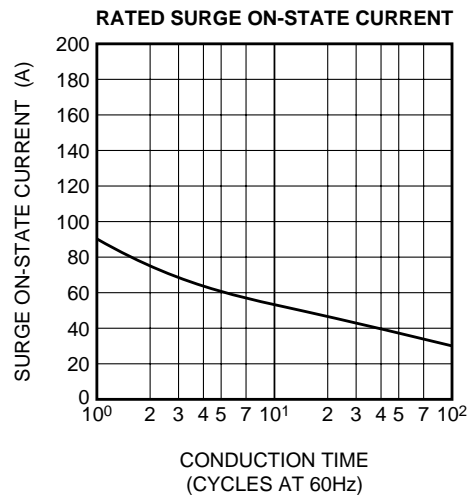
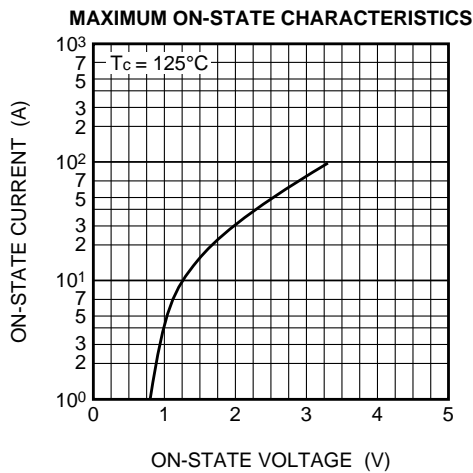

CR6CM

MEDIUM POWER USE

NON-INSULATED TYPE, GLASS PASSIVATION TYPE

GATE CHARACTERISTICS

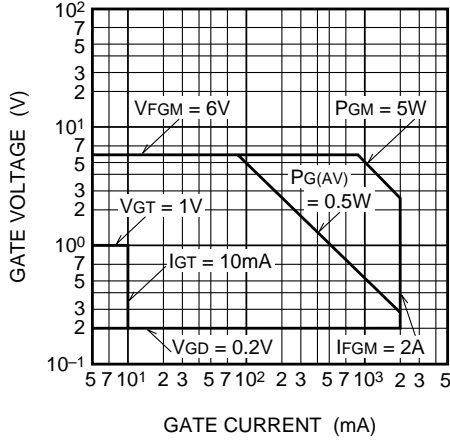

GATE TRIGGER CURRENT VS. JUNCTION TEMPERATURE

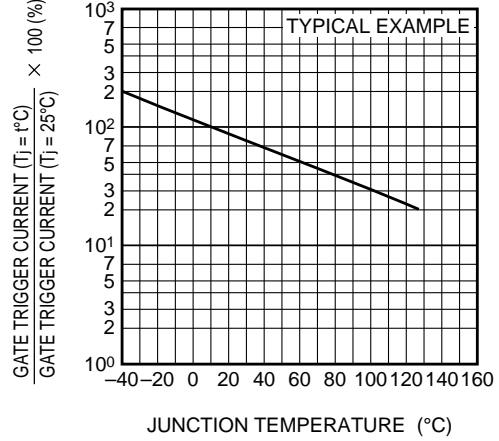

GATE TRIGGER VOLTAGE VS. JUNCTION TEMPERATURE

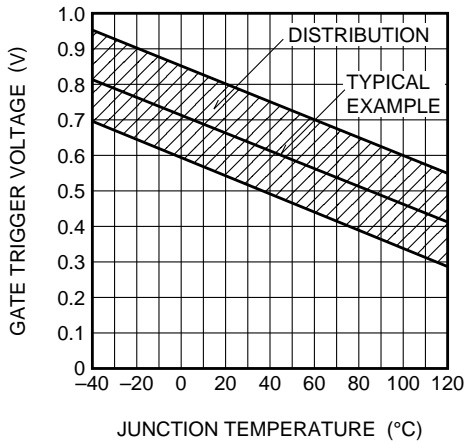

MAXIMUM TRANSIENT THERMAL IMPEDANCE CHARACTERISTICS (JUNCTION TO CASE)

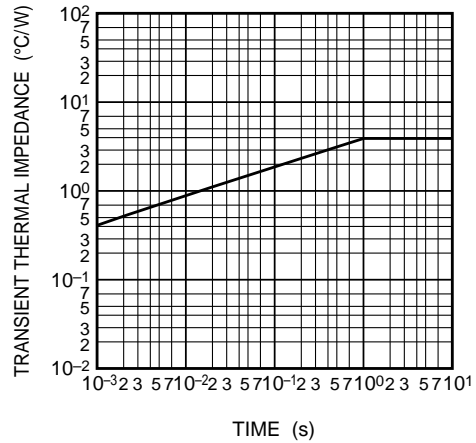

MAXIMUM AVERAGE POWER DISSIPATION (SINGLE-PHASE HALF WAVE)

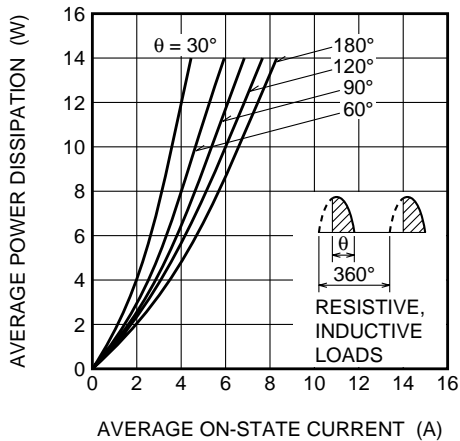

ALLOWABLE CASE TEMPERATURE VS. AVERAGE ON-STATE CURRENT (SINGLE-PHASE HALF WAVE)

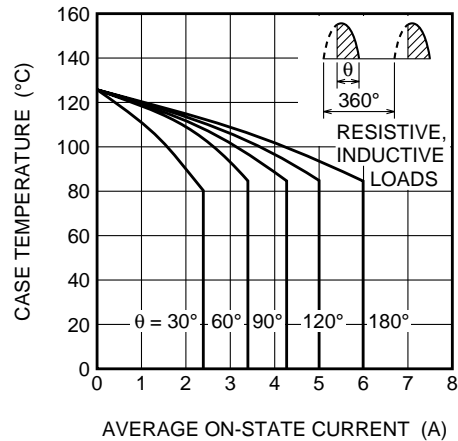

CR6CM

MEDIUM POWER USE

NON-INSULATED TYPE, GLASS PASSIVATION TYPE

**MAXIMUM AVERAGE POWER DISSIPATION
(SINGLE-PHASE FULL WAVE)**

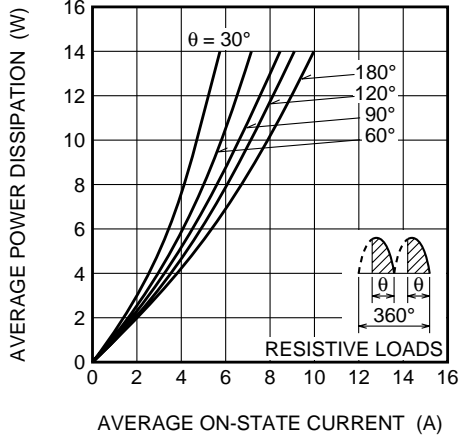

**ALLOWABLE CASE TEMPERATURE VS.
AVERAGE ON-STATE CURRENT
(SINGLE-PHASE FULL WAVE)**

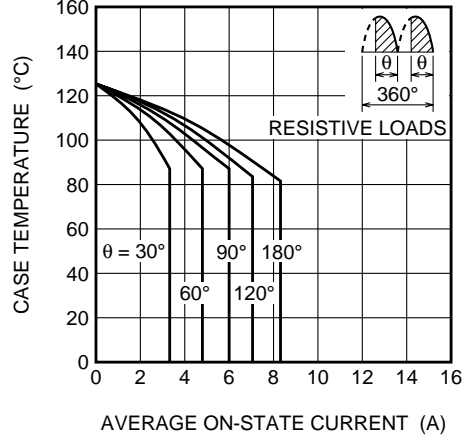

**MAXIMUM AVERAGE POWER DISSIPATION
(RECTANGULAR WAVE)**

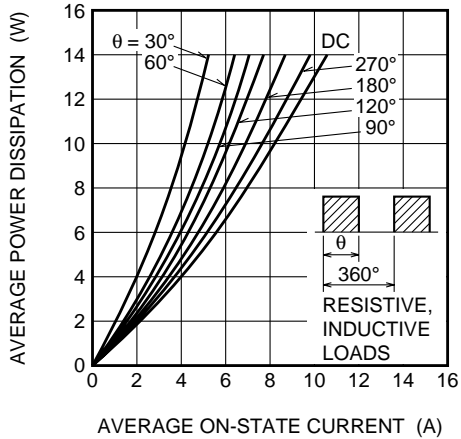

**ALLOWABLE AMBIENT TEMPERATURE VS.
AVERAGE ON-STATE CURRENT
(RECTANGULAR WAVE)**

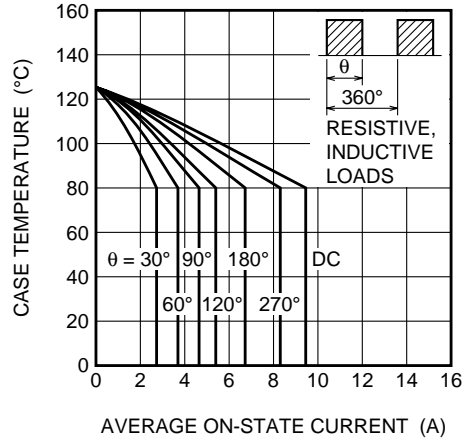

**BREAKOVER VOLTAGE VS.
JUNCTION TEMPERATURE**

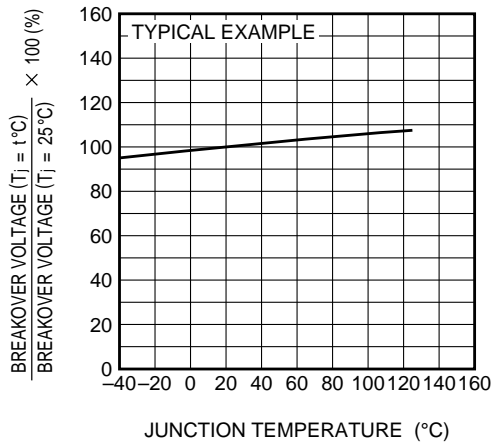

**BREAKOVER VOLTAGE VS.
RATE OF RISE OF OFF-STATE VOLTAGE**

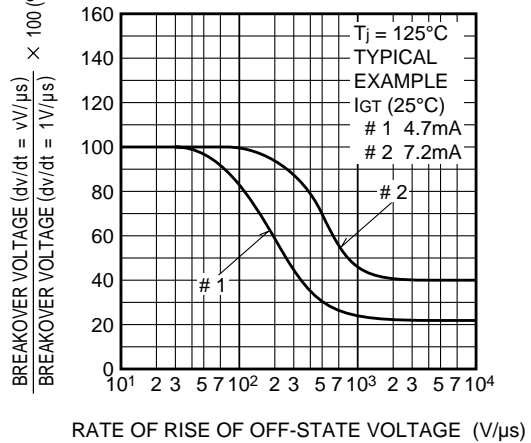

CR6CM

MEDIUM POWER USE

NON-INSULATED TYPE, GLASS PASSIVATION TYPE

HOLDING CURRENT VS. JUNCTION TEMPERATURE

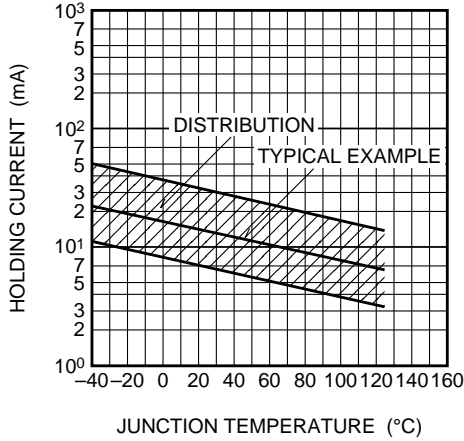

HOLDING CURRENT VS. GATE TRIGGER CURRENT

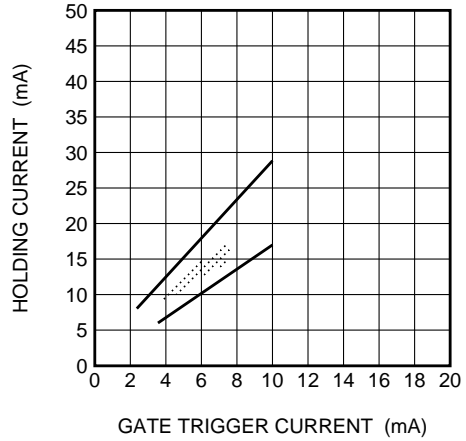

TURN-ON TIME VS. GATE CURRENT

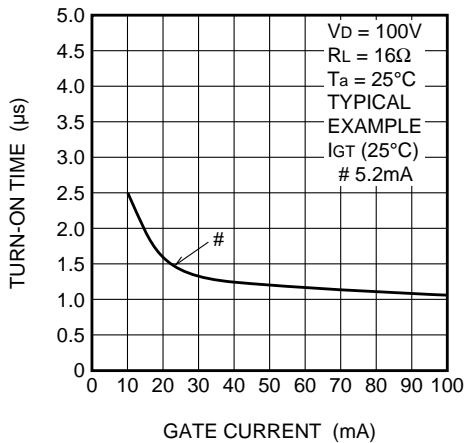

TURN-OFF TIME VS. JUNCTION TEMPERATURE

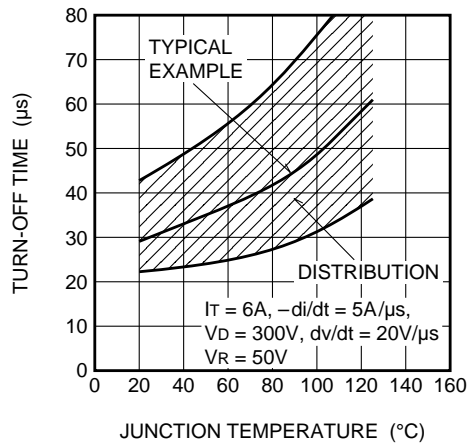

REPETITIVE PEAK REVERSE VOLTAGE VS. JUNCTION TEMPERATURE

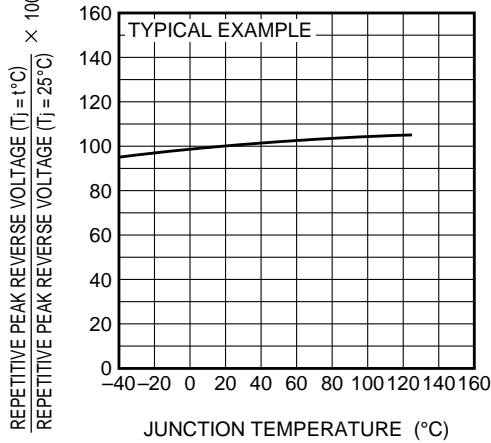

GATE TRIGGER CURRENT VS. GATE CURRENT PULSE WIDTH

