

Full - Bridge MOSFET Power Module

$V_{DSS} = 500V$
 $R_{DSon} = 100m\Omega \text{ typ @ } T_j = 25^\circ C$
 $I_D = 37A \text{ @ } T_c = 25^\circ C$

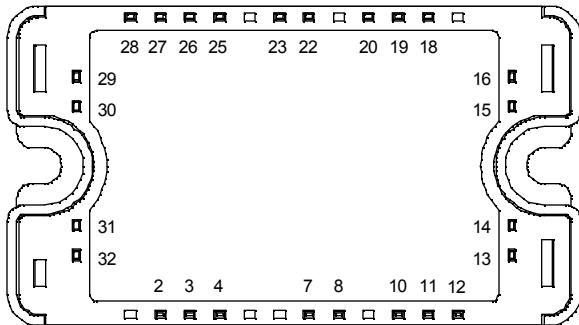
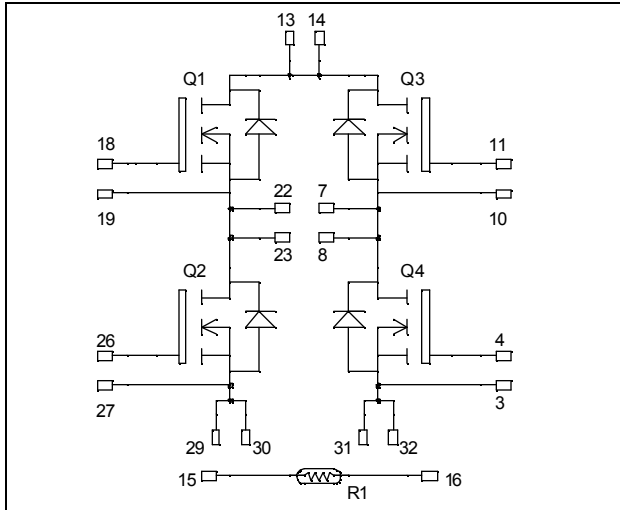

All multiple inputs and outputs must be shorted together
 Example: 13/14 ; 29/30 ; 22/23 ...

Application

- Welding converters
- Switched Mode Power Supplies
- Uninterruptible Power Supplies

Features

- Power MOS 7[®] FREDFETs
 - Low R_{DSon}
 - Low input and Miller capacitance
 - Low gate charge
 - Fast intrinsic reverse diode
 - Avalanche energy rated
 - Very rugged
- Kelvin source for easy drive
- Very low stray inductance
 - Symmetrical design
- Internal thermistor for temperature monitoring
- High level of integration

Benefits

- Outstanding performance at high frequency operation
- Direct mounting to heatsink (isolated package)
- Low junction to case thermal resistance
- Solderable terminals both for power and signal for easy PCB mounting
- Low profile
- Each leg can be easily paralleled to achieve a phase leg of twice the current capability
- RoHS Compliant

Absolute maximum ratings

Symbol	Parameter	Max ratings	Unit
V_{DSS}	Drain - Source Breakdown Voltage	500	V
I_D	Continuous Drain Current	$T_c = 25^\circ C$	37
		$T_c = 80^\circ C$	28
I_{DM}	Pulsed Drain current	140	A
V_{GS}	Gate - Source Voltage	± 30	V
R_{DSon}	Drain - Source ON Resistance	120	$m\Omega$
P_D	Maximum Power Dissipation	$T_c = 25^\circ C$	312
I_{AR}	Avalanche current (repetitive and non repetitive)	37	A
E_{AR}	Repetitive Avalanche Energy	50	mJ
E_{AS}	Single Pulse Avalanche Energy	1600	

CAUTION: These Devices are sensitive to Electrostatic Discharge. Proper Handling Procedures Should Be Followed. See application note APT0502 on www.microsemi.com

All ratings @ $T_j = 25^\circ\text{C}$ unless otherwise specified

Electrical Characteristics

Symbol	Characteristic	Test Conditions	Min	Typ	Max	Unit
I_{DSS}	Zero Gate Voltage Drain Current	$V_{GS} = 0\text{V}, V_{DS} = 500\text{V}$			100	μA
		$V_{GS} = 0\text{V}, V_{DS} = 400\text{V}$			500	
$R_{DS(on)}$	Drain – Source on Resistance	$V_{GS} = 10\text{V}, I_D = 18.5\text{A}$		100	120	$\text{m}\Omega$
$V_{GS(th)}$	Gate Threshold Voltage	$V_{GS} = V_{DS}, I_D = 1\text{mA}$	3		5	V
I_{GSS}	Gate – Source Leakage Current	$V_{GS} = \pm 30\text{V}, V_{DS} = 0\text{V}$			± 100	nA

Dynamic Characteristics

Symbol	Characteristic	Test Conditions	Min	Typ	Max	Unit
C_{iss}	Input Capacitance	$V_{GS} = 0\text{V}$		4367		pF
C_{oss}	Output Capacitance	$V_{DS} = 25\text{V}$		894		
C_{rss}	Reverse Transfer Capacitance	$f = 1\text{MHz}$		61		
Q_g	Total gate Charge	$V_{GS} = 10\text{V}$ $V_{Bus} = 250\text{V}$ $I_D = 37\text{A}$		96		nC
Q_{gs}	Gate – Source Charge			24		
Q_{gd}	Gate – Drain Charge			49		
$T_{d(on)}$	Turn-on Delay Time	Inductive switching @ 125°C $V_{GS} = 15\text{V}$ $V_{Bus} = 333\text{V}$ $I_D = 37\text{A}$ $R_G = 5\Omega$		15		ns
T_r	Rise Time			21		
$T_{d(off)}$	Turn-off Delay Time			73		
T_f	Fall Time			52		
E_{on}	Turn-on Switching Energy	Inductive switching @ 25°C $V_{GS} = 15\text{V}, V_{Bus} = 333\text{V}$ $I_D = 37\text{A}, R_G = 5\Omega$		566		μJ
E_{off}	Turn-off Switching Energy			545		
E_{on}	Turn-on Switching Energy	Inductive switching @ 125°C $V_{GS} = 15\text{V}, V_{Bus} = 333\text{V}$ $I_D = 37\text{A}, R_G = 5\Omega$		931		μJ
E_{off}	Turn-off Switching Energy			635		

Source - Drain diode ratings and characteristics

Symbol	Characteristic	Test Conditions	Min	Typ	Max	Unit
I_S	Continuous Source current (Body diode)	$T_c = 25^\circ\text{C}$		37		A
		$T_c = 80^\circ\text{C}$		28		
V_{SD}	Diode Forward Voltage	$V_{GS} = 0\text{V}, I_S = -37\text{A}$			1.3	V
dv/dt	Peak Diode Recovery ①				15	V/ns
t_{rr}	Reverse Recovery Time	$I_S = -37\text{A}$ $V_R = 333\text{V}$ $di/dt = 100\text{A}/\mu\text{s}$	$T_j = 25^\circ\text{C}$		280	ns
			$T_j = 125^\circ\text{C}$		600	
Q_{rr}	Reverse Recovery Charge	$I_S = -37\text{A}$ $V_R = 333\text{V}$ $di/dt = 100\text{A}/\mu\text{s}$	$T_j = 25^\circ\text{C}$		2.3	μC
			$T_j = 125^\circ\text{C}$		6.4	

① dv/dt numbers reflect the limitations of the circuit rather than the device itself.

 $I_S \leq -37\text{A}$ $di/dt \leq 100\text{A}/\mu\text{s}$ $V_R \leq V_{DSS}$ $T_j \leq 150^\circ\text{C}$

Thermal and package characteristics

Symbol	Characteristic	Min	Typ	Max	Unit	
R _{thJC}	Junction to Case Thermal Resistance			0.40	°C/W	
V _{ISOL}	RMS Isolation Voltage, any terminal to case t=1 min, I _{isol} <1mA, 50/60Hz	2500			V	
T _J	Operating junction temperature range	-40		150	°C	
T _{STG}	Storage Temperature Range	-40		125		
T _C	Operating Case Temperature	-40		100		
Torque	Mounting torque	To heatsink	M4	2.5	4.7	N.m
Wt	Package Weight				110	g

Temperature sensor NTC (see application note APT0406 on www.microsemi.com for more information).

Symbol	Characteristic	Min	Typ	Max	Unit
R ₂₅	Resistance @ 25°C		50		kΩ
B _{25/85}	T ₂₅ = 298.15 K		3952		K

$$R_T = \frac{R_{25}}{\exp\left[B_{25/85}\left(\frac{1}{T_{25}} - \frac{1}{T}\right)\right]}$$

T: Thermistor temperature
 R_T: Thermistor value at T

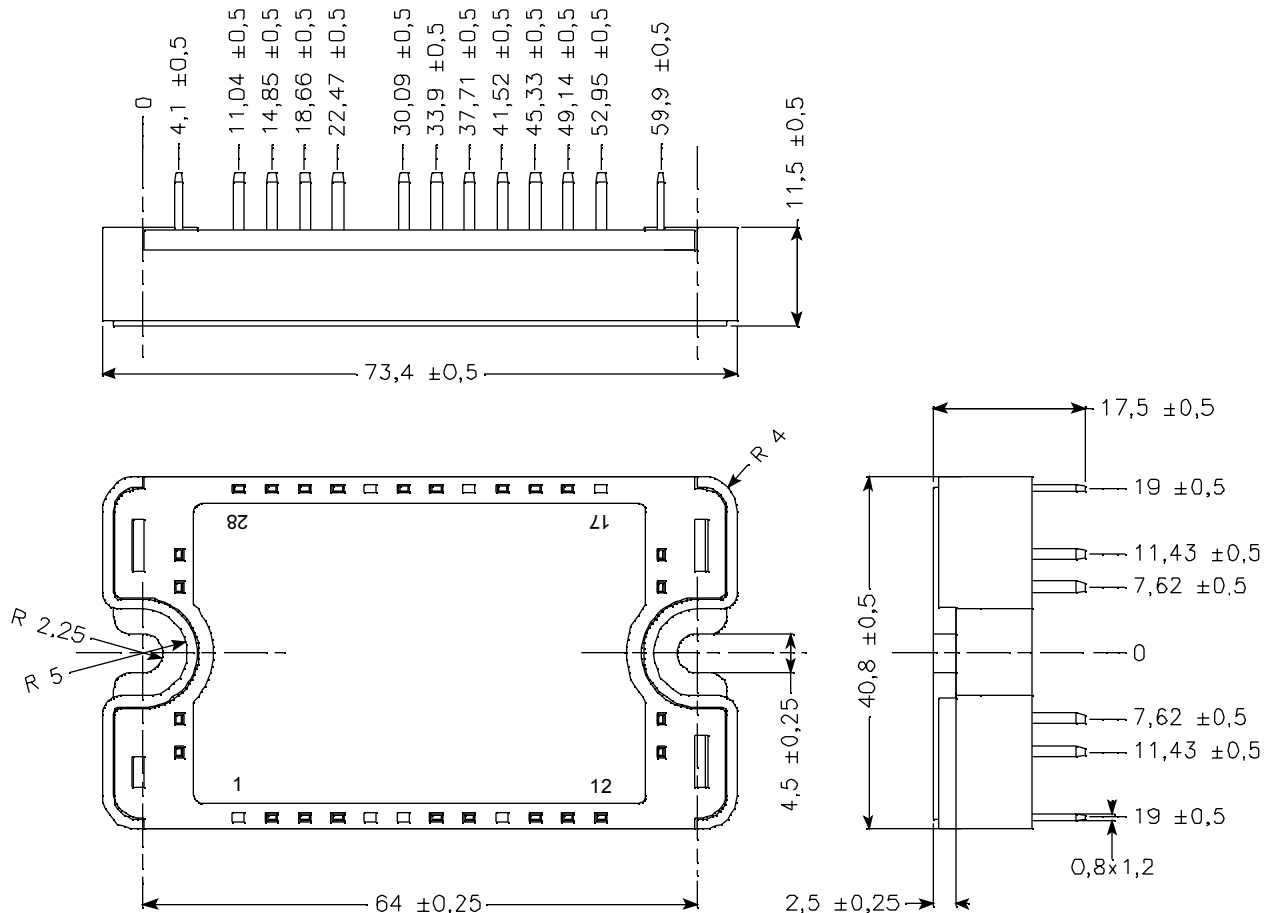
SP3 Package outline (dimensions in mm)

 See application note 1901 - Mounting Instructions for SP3 Power Modules on www.microsemi.com

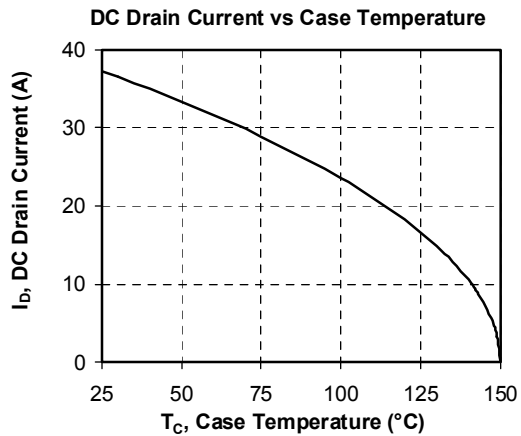
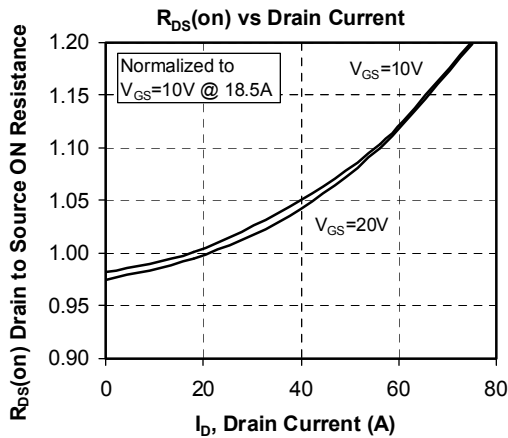
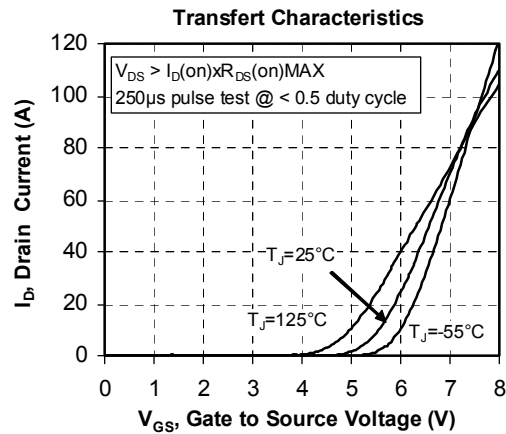
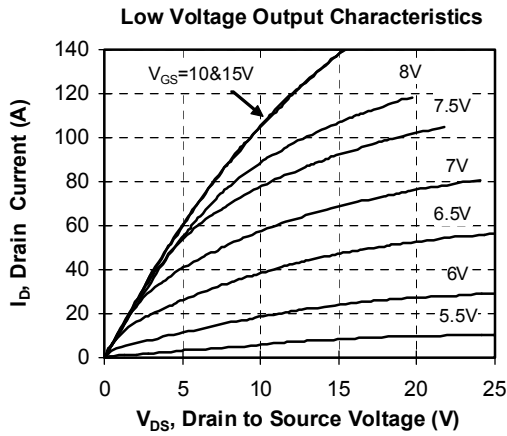
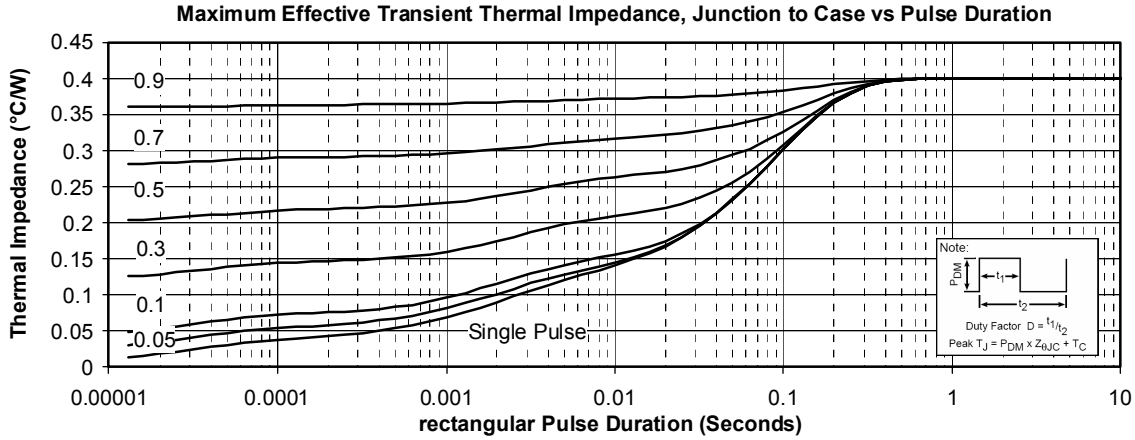
Typical Performance Curve

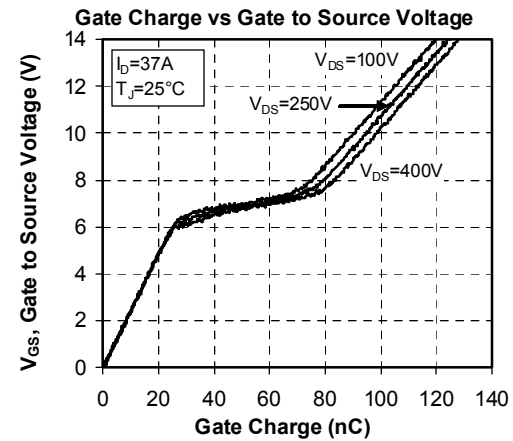
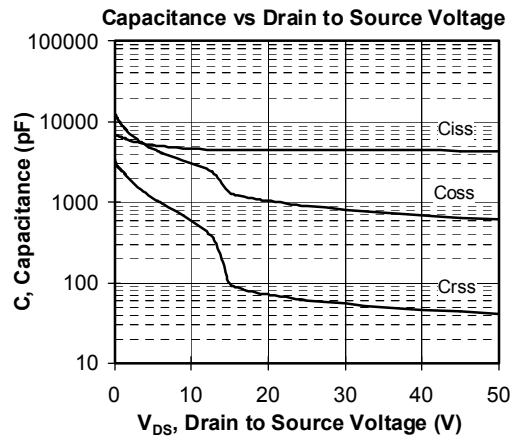
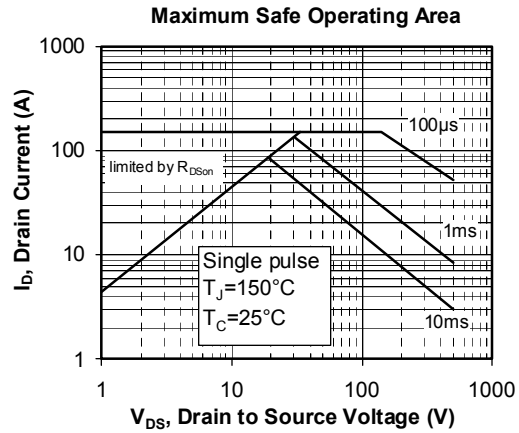
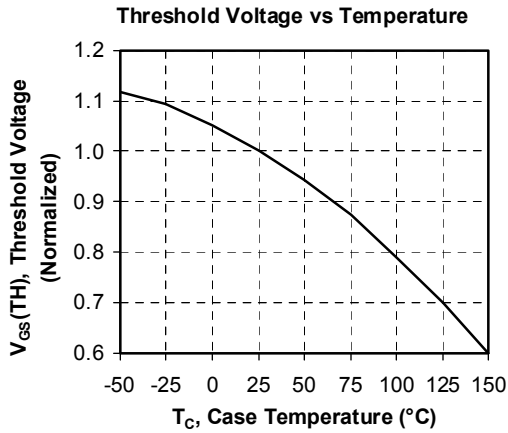
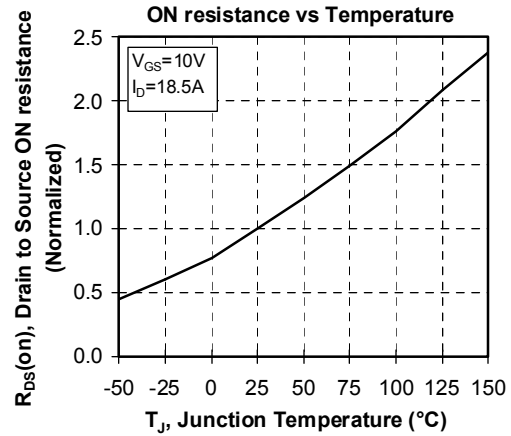
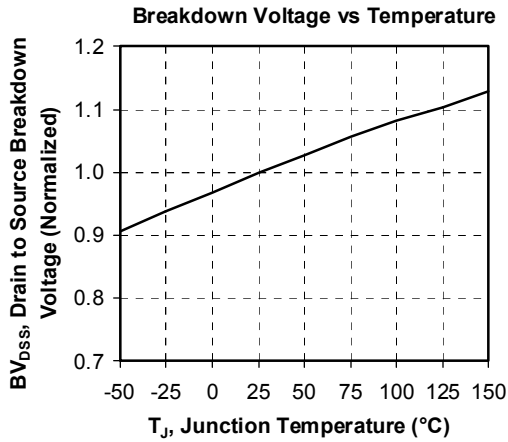

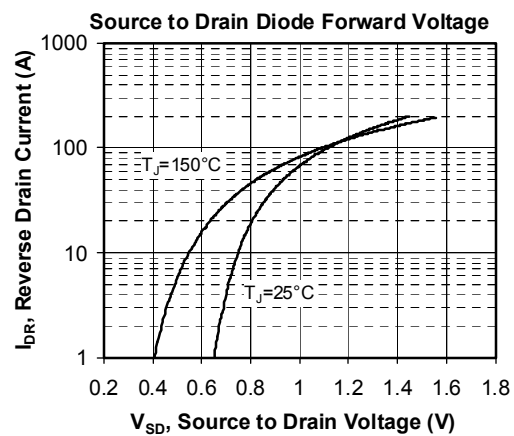
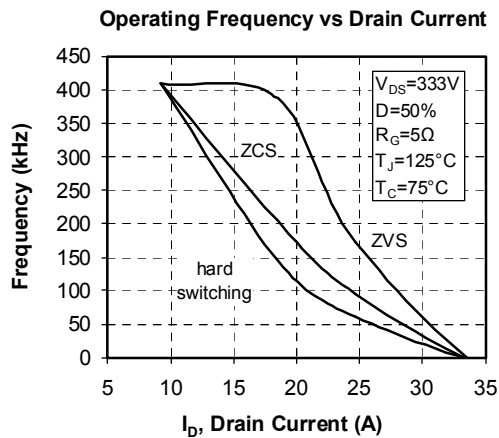
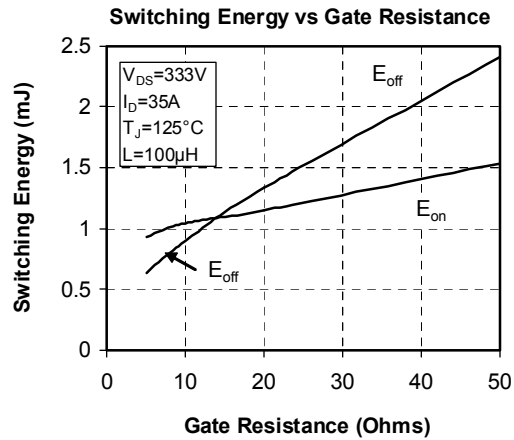
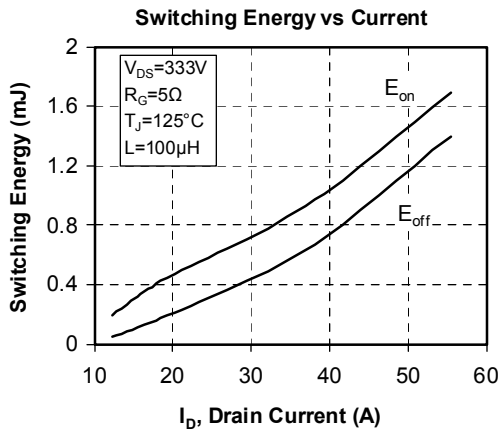
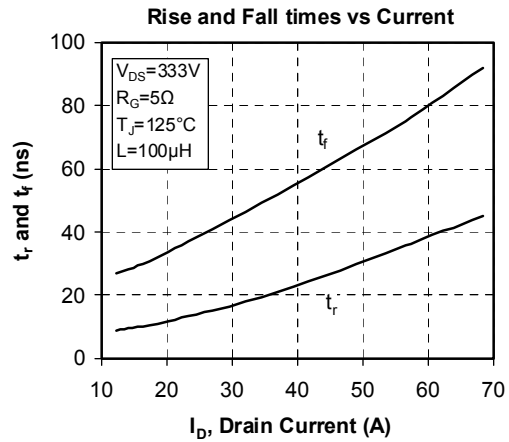
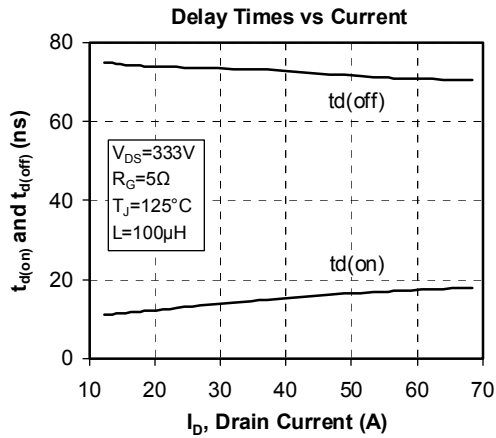



Microsemi reserves the right to change, without notice, the specifications and information contained herein

Microsemi's products are covered by one or more of U.S. patents 4,895,810 5,045,903 5,089,434 5,182,234 5,019,522 5,262,336 6,503,786 5,256,583 4,748,103 5,283,202 5,231,474 5,434,095 5,528,058 and foreign patents. U.S. and Foreign patents pending. All Rights Reserved.