

Triple dual common source MOSFET Power Module

$V_{DSS} = 75V$
 $R_{DSon} = 4.2m\Omega \text{ max @ } T_j = 25^\circ C$
 $I_D = 120A \text{ @ } T_c = 25^\circ C$

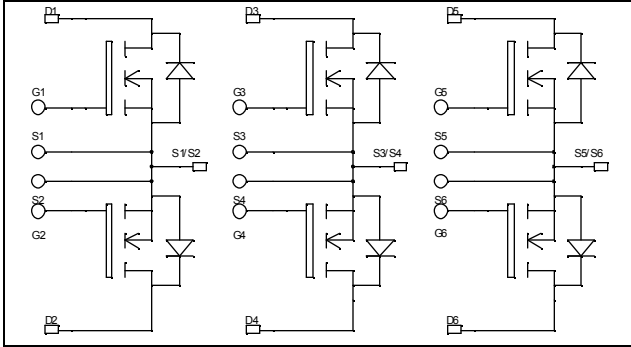

Application

- AC Switches
- Switched Mode Power Supplies
- Uninterruptible Power Supplies

Features

- Power MOSFETs
 - Low R_{DSon}
 - Low input and Miller capacitance
 - Low gate charge
 - Avalanche energy rated
 - Very rugged
- Kelvin source for easy drive
- Very low stray inductance
 - Symmetrical design
 - Lead frames for power connections
- High level of integration

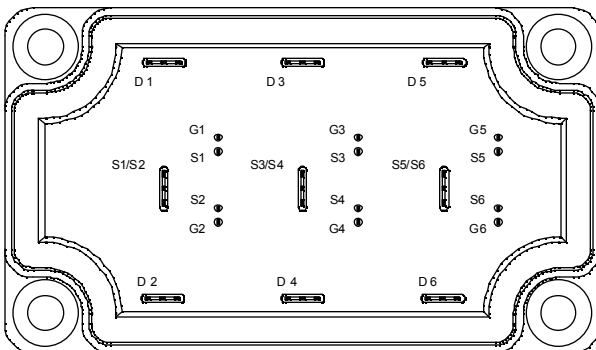

Benefits

- Outstanding performance at high frequency operation
- Direct mounting to heatsink (isolated package)
- Low junction to case thermal resistance
- Solderable terminals both for power and signal for easy PCB mounting
- Very low (12mm) profile
- Each leg can be easily paralleled to achieve a phase leg of three times the current capability
- RoHS Compliant

Absolute maximum ratings

Symbol	Parameter	Max ratings	Unit
V_{DSS}	Drain - Source Breakdown Voltage	75	V
I_D	Continuous Drain Current	$T_c = 25^\circ C$	120
		$T_c = 80^\circ C$	90
I_{DM}	Pulsed Drain current	250	A
V_{GS}	Gate - Source Voltage	± 30	V
R_{DSon}	Drain - Source ON Resistance	4.5	$m\Omega$
P_D	Maximum Power Dissipation	$T_c = 25^\circ C$	138
I_{AR}	Avalanche current (repetitive and non repetitive)	75	A
E_{AR}	Repetitive Avalanche Energy	50	mJ
E_{AS}	Single Pulse Avalanche Energy	1500	

CAUTION: These Devices are sensitive to Electrostatic Discharge. Proper Handling Procedures Should Be Followed. See application note APT0502 on www.microsemi.com

All ratings @ $T_j = 25^\circ\text{C}$ unless otherwise specified

Electrical Characteristics

Symbol	Characteristic	Test Conditions	Min	Typ	Max	Unit
I_{DSS}	Zero Gate Voltage Drain Current	$V_{GS} = 0\text{V}, V_{DS} = 75\text{V}$			100	μA
		$V_{GS} = 0\text{V}, V_{DS} = 60\text{V}$	$T_j = 25^\circ\text{C}$		250	
$R_{DS(on)}$	Drain – Source on Resistance	$V_{GS} = 10\text{V}, I_D = 60\text{A}$		4.2	4.5	$\text{m}\Omega$
$V_{GS(th)}$	Gate Threshold Voltage	$V_{GS} = V_{DS}, I_D = 1\text{mA}$	2		4	V
I_{GSS}	Gate – Source Leakage Current	$V_{GS} = \pm 30\text{V}, V_{DS} = 0\text{V}$			± 100	nA

Dynamic Characteristics

Symbol	Characteristic	Test Conditions	Min	Typ	Max	Unit
C_{iss}	Input Capacitance	$V_{GS} = 0\text{V}$ $V_{DS} = 25\text{V}$ $f = 1\text{MHz}$		4530		pF
C_{oss}	Output Capacitance			1080		
C_{rss}	Reverse Transfer Capacitance			450		
Q_g	Total gate Charge	$V_{GS} = 10\text{V}$ $V_{Bus} = 60\text{V}$ $I_D = 120\text{A}$		153		nC
Q_{gs}	Gate – Source Charge			25		
Q_{gd}	Gate – Drain Charge			82		
$T_{d(on)}$	Turn-on Delay Time	Inductive switching @ 125°C $V_{GS} = 15\text{V}$ $V_{Bus} = 40\text{V}$ $I_D = 120\text{A}$ $R_G = 5\Omega$		35		ns
T_r	Rise Time			60		
$T_{d(off)}$	Turn-off Delay Time			100		
T_f	Fall Time			65		
E_{on}	Turn-on Switching Energy	Inductive switching @ 25°C $V_{GS} = 15\text{V}, V_{Bus} = 40\text{V}$ $I_D = 120\text{A}, R_G = 5\Omega$		290		μJ
E_{off}	Turn-off Switching Energy			317		
E_{on}	Turn-on Switching Energy	Inductive switching @ 125°C $V_{GS} = 15\text{V}, V_{Bus} = 40\text{V}$ $I_D = 120\text{A}, R_G = 5\Omega$		319		μJ
E_{off}	Turn-off Switching Energy			336		

Source - Drain diode ratings and characteristics

Symbol	Characteristic	Test Conditions	Min	Typ	Max	Unit
I_S	Continuous Source current (Body diode)		$T_c = 25^\circ\text{C}$		120	A
			$T_c = 80^\circ\text{C}$		90	
V_{SD}	Diode Forward Voltage	$V_{GS} = 0\text{V}, I_S = -120\text{A}$			1.3	V
dv/dt	Peak Diode Recovery ①				6	V/ns
t_{rr}	Reverse Recovery Time	$I_S = -120\text{A}$ $V_R = 40\text{V}$	$T_j = 25^\circ\text{C}$	100	200	ns
Q_{rr}	Reverse Recovery Charge	$di_s/dt = 100\text{A}/\mu\text{s}$	$T_j = 25^\circ\text{C}$	300		nC

① dv/dt numbers reflect the limitations of the circuit rather than the device itself.

$$I_S \leq -120\text{A} \quad di/dt \leq 700\text{A}/\mu\text{s} \quad V_R \leq V_{DSS} \quad T_j \leq 150^\circ\text{C}$$

Thermal and package characteristics
Symbol Characteristic

		<i>Min</i>	<i>Typ</i>	<i>Max</i>	<i>Unit</i>	
R_{thJC}	Junction to Case Thermal Resistance			0.9	°C/W	
V_{ISOL}	RMS Isolation Voltage, any terminal to case t=1 min, I isol<1mA, 50/60Hz	2500			V	
T_J	Operating junction temperature range	-40		150	°C	
T_{STG}	Storage Temperature Range	-40		125		
T_C	Operating Case Temperature	-40		100		
Torque	Mounting torque	To heatsink	M6	3	5	N.m
Wt	Package Weight				250	g

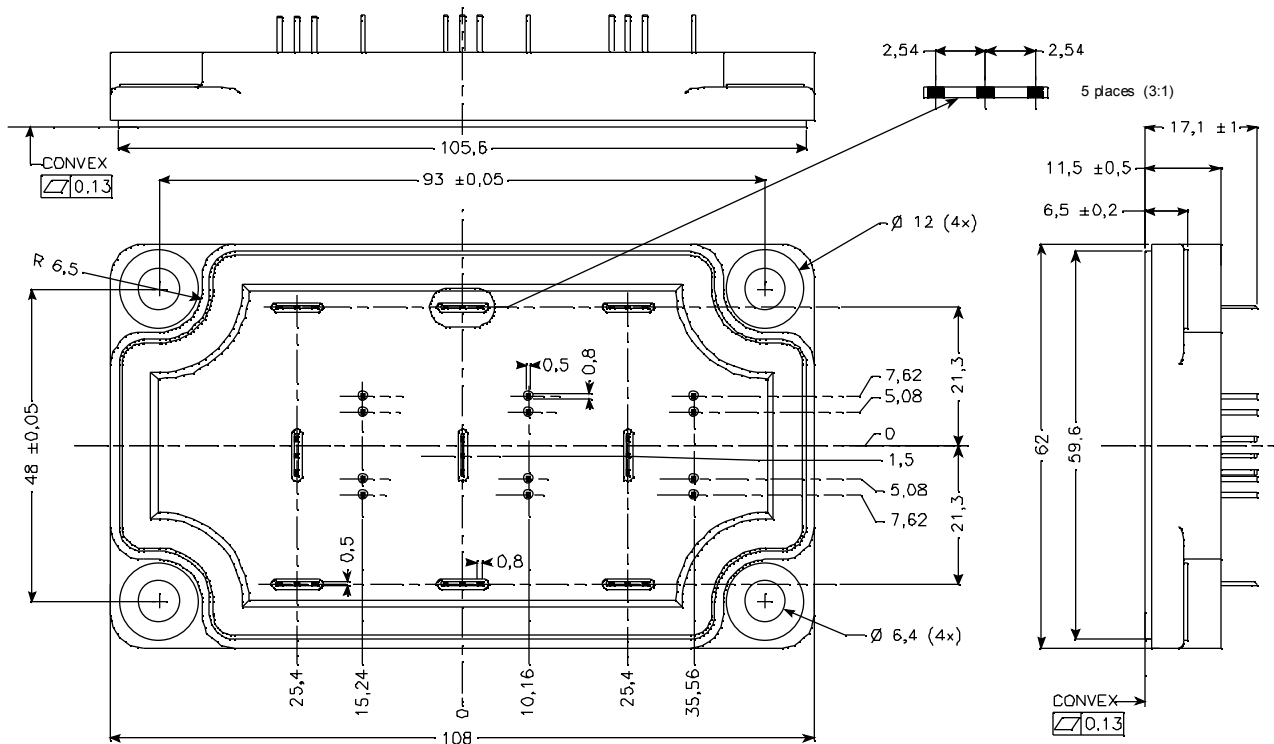
SP6-P Package outline (dimensions in mm)

 See application note 1902 - Mounting Instructions for SP6-P (12mm) Power Modules on www.microsemi.com

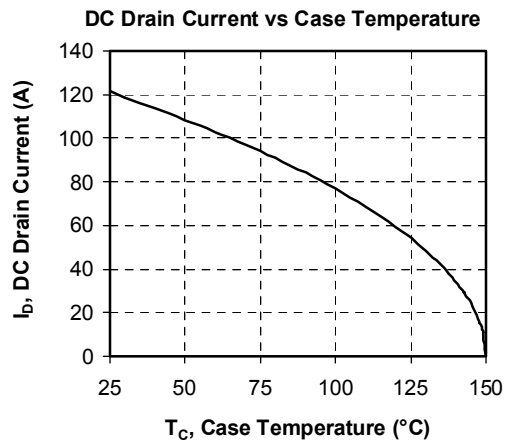
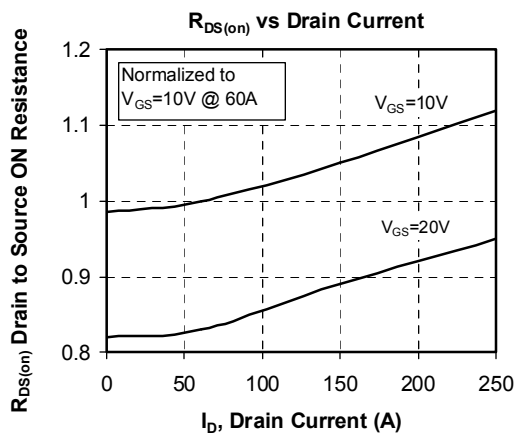
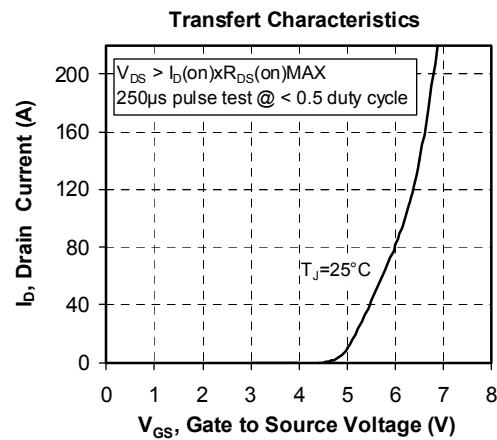
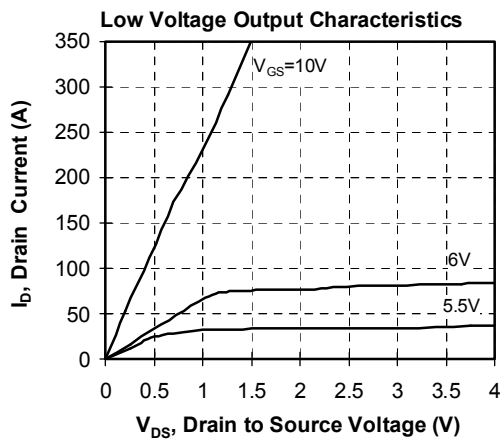
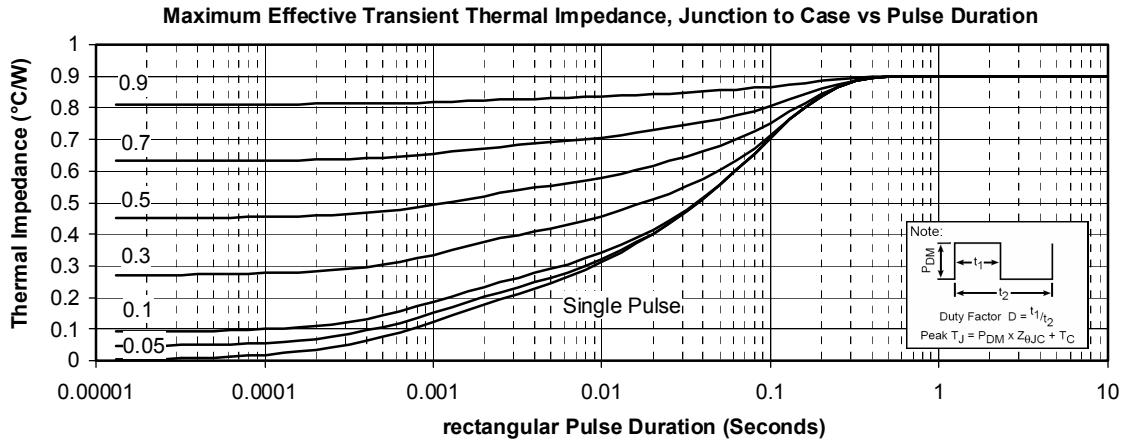
Typical Performance Curve

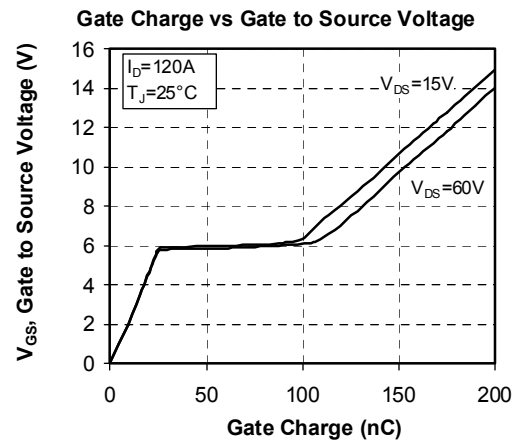
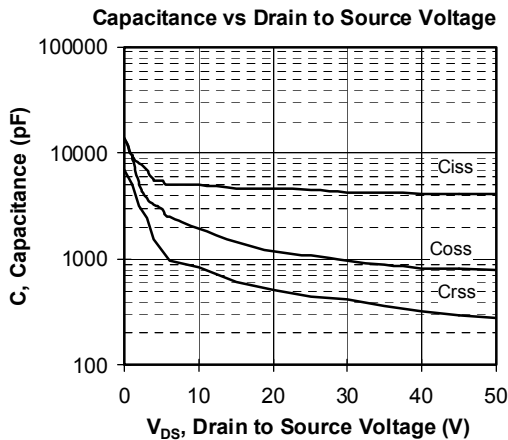
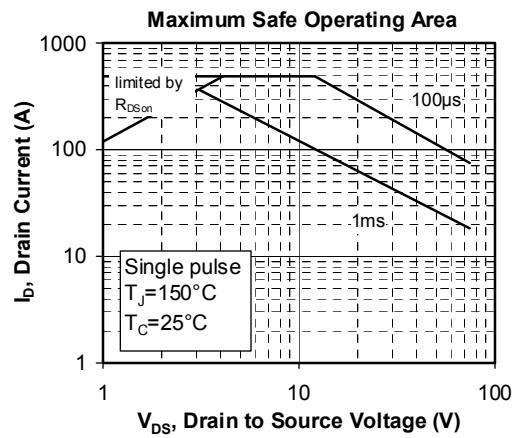
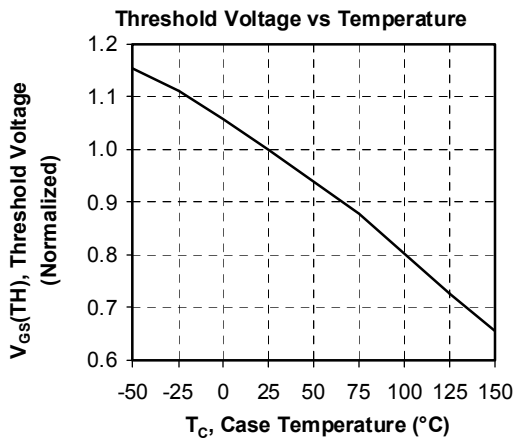
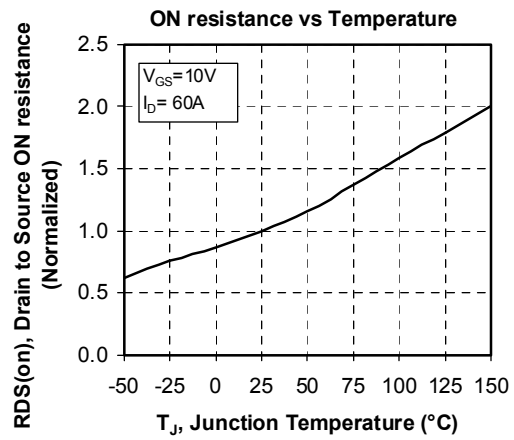
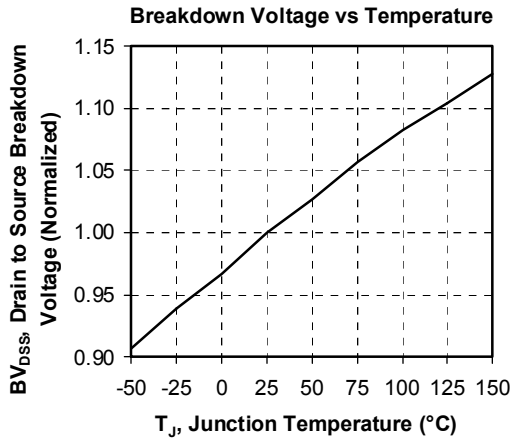

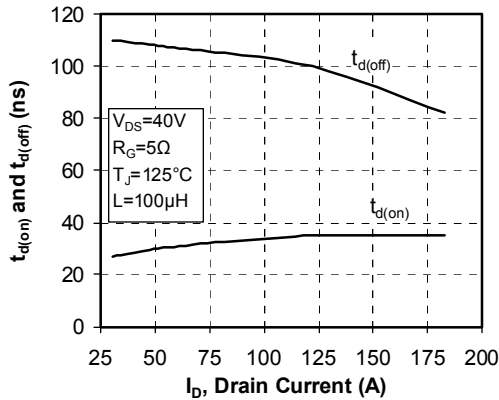
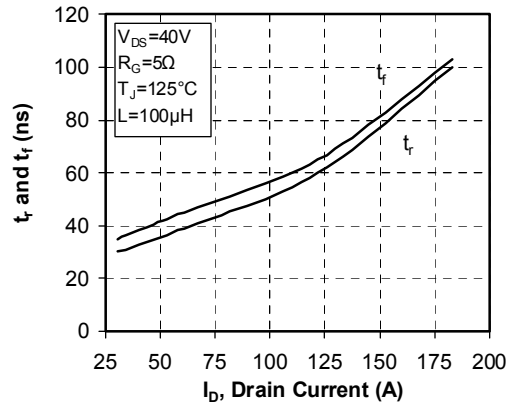
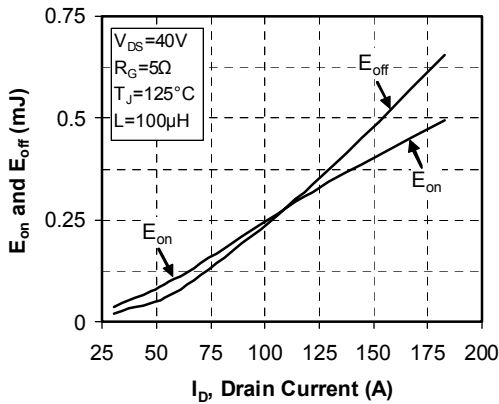
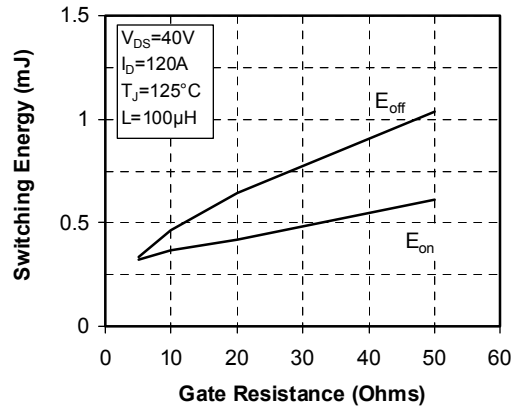
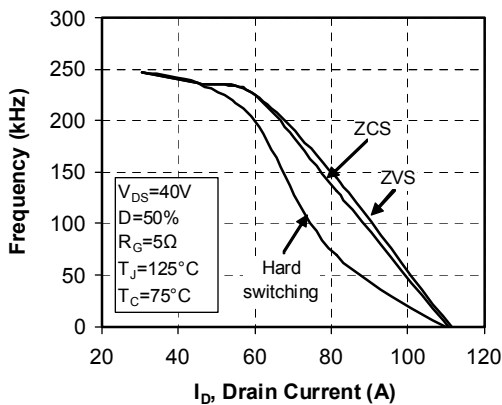
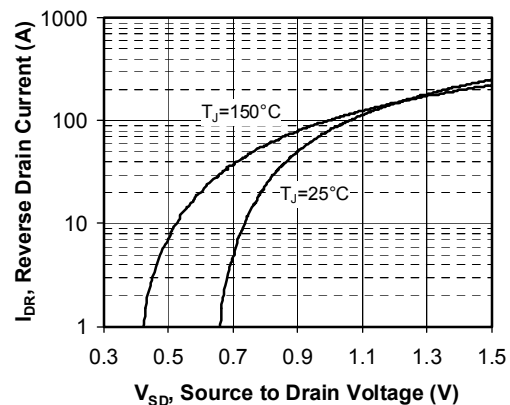

Delay Times vs Current

Rise and Fall times vs Current

Switching Energy vs Current

Switching Energy vs Gate Resistance

Operating Frequency vs Drain Current

Source to Drain Diode Forward Voltage

Microsemi reserves the right to change, without notice, the specifications and information contained herein

Microsemi's products are covered by one or more of U.S. patents 4,895,810 5,045,903 5,089,434 5,182,234 5,019,522 5,262,336 6,503,786 5,256,583 4,748,103 5,283,202 5,231,474 5,434,095 5,528,058 and foreign patents. U.S. and Foreign patents pending. All Rights Reserved.