

## Buck chopper NPT IGBT Power Module

$V_{CES} = 1200V$   
 $I_C = 50A @ T_c = 80^\circ C$

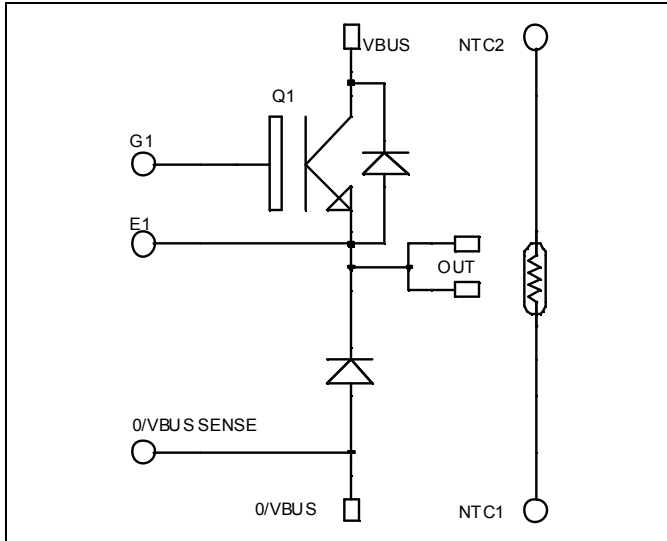

### Application

- AC and DC motor control
- Switched Mode Power Supplies

### Features

- Non Punch Through (NPT) Fast IGBT®
  - Low voltage drop
  - Low tail current
  - Switching frequency up to 50 kHz
  - Soft recovery parallel diodes
  - Low diode VF
  - Low leakage current
  - Avalanche energy rated
  - RBSOA and SCSOA rated
- Kelvin emitter for easy drive
- Very low stray inductance
  - Symmetrical design
  - Lead frames for power connections
- Internal thermistor for temperature monitoring
- High level of integration

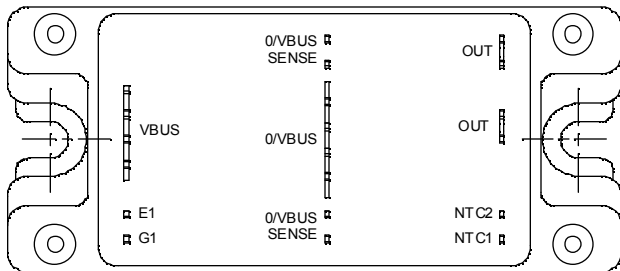

### Benefits

- Outstanding performance at high frequency operation
- Stable temperature behavior
- Very rugged
- Direct mounting to heatsink (isolated package)
- Low junction to case thermal resistance
- Solderable terminals both for power and signal for easy PCB mounting
- Easy paralleling due to positive  $T_C$  of  $V_{CESat}$
- Low profile
- RoHS compliant

### Absolute maximum ratings

Symbol	Parameter	Max ratings	Unit
$V_{CES}$	Collector - Emitter Breakdown Voltage	1200	V
$I_C$	Continuous Collector Current	$T_c = 25^\circ C$	75
		$T_c = 80^\circ C$	50
$I_{CM}$	Pulsed Collector Current	$T_c = 25^\circ C$	150
$V_{GE}$	Gate - Emitter Voltage	$\pm 20$	V
$P_D$	Maximum Power Dissipation	$T_c = 25^\circ C$	312
RBSOA	Reverse Bias Safe Operating Area	$T_j = 150^\circ C$	100A @ 1200V

**CAUTION:** These Devices are sensitive to Electrostatic Discharge. Proper Handling Procedures Should Be Followed. See application note APT0502 on [www.microsemi.com](http://www.microsemi.com)

All ratings @  $T_j = 25^\circ\text{C}$  unless otherwise specified

**Electrical Characteristics**

Symbol	Characteristic	Test Conditions	Min	Typ	Max	Unit
$I_{CES}$	Zero Gate Voltage Collector Current	$V_{GE} = 0\text{V}$ $V_{CE} = 1200\text{V}$			250 500	$\mu\text{A}$
$V_{CE(sat)}$	Collector Emitter saturation Voltage	$V_{GE} = 15\text{V}$ $I_C = 50\text{A}$		3.2 4.0	3.7	V
$V_{GE(th)}$	Gate Threshold Voltage	$V_{GE} = V_{CE}, I_C = 1\text{mA}$	4.5		6.5	V
$I_{GES}$	Gate – Emitter Leakage Current	$V_{GE} = 20\text{V}, V_{CE} = 0\text{V}$			100	nA

**Dynamic Characteristics**

Symbol	Characteristic	Test Conditions	Min	Typ	Max	Unit
$C_{ies}$	Input Capacitance	$V_{GE} = 0\text{V}$		3450		pF
$C_{oes}$	Output Capacitance	$V_{CE} = 25\text{V}$		330		
$C_{res}$	Reverse Transfer Capacitance	$f = 1\text{MHz}$		220		
$Q_g$	Total gate Charge	$V_{GS} = 15\text{V}$		330		nC
$Q_{ge}$	Gate – Emitter Charge	$V_{Bus} = 600\text{V}$		35		
$Q_{gc}$	Gate – Collector Charge	$I_C = 50\text{A}$		200		
$T_{d(on)}$	Turn-on Delay Time	Inductive Switching ( $25^\circ\text{C}$ )		35		ns
$T_r$	Rise Time	$V_{GE} = 15\text{V}$ $V_{Bus} = 600\text{V}$		65		
$T_{d(off)}$	Turn-off Delay Time	$I_C = 50\text{A}$		320		
$T_f$	Fall Time	$R_G = 5\ \Omega$		30		
$T_{d(on)}$	Turn-on Delay Time	Inductive Switching ( $125^\circ\text{C}$ )		35		ns
$T_r$	Rise Time	$V_{GE} = \pm 15\text{V}$ $V_{Bus} = 600\text{V}$		65		
$T_{d(off)}$	Turn-off Delay Time	$I_C = 50\text{A}$		360		
$T_f$	Fall Time	$R_G = 5\ \Omega$		40		
$E_{on}$	Turn-on Switching Energy	$V_{GE} = \pm 15\text{V}$ $V_{Bus} = 600\text{V}$	$T_j = 125^\circ\text{C}$	6.9		mJ
$E_{off}$	Turn-off Switching Energy	$I_C = 50\text{A}$ $R_G = 5\ \Omega$	$T_j = 125^\circ\text{C}$	3.05		

**Chopper diode ratings and characteristics**

Symbol	Characteristic	Test Conditions	Min	Typ	Max	Unit
$V_{RRM}$	Maximum Peak Repetitive Reverse Voltage		1200			V
$I_{RM}$	Maximum Reverse Leakage Current	$V_R = 1200\text{V}$			250 500	$\mu\text{A}$
$I_F$	DC Forward Current			60		A
$V_F$	Diode Forward Voltage	$I_F = 60\text{A}$		2.0	2.5	V
		$I_F = 120\text{A}$		2.3		
		$I_F = 60\text{A}$ $T_j = 125^\circ\text{C}$		1.8		
$t_{rr}$	Reverse Recovery Time	$I_F = 60\text{A}$ $V_R = 800\text{V}$	$T_j = 25^\circ\text{C}$ $T_j = 125^\circ\text{C}$	400 470		ns
$Q_{rr}$	Reverse Recovery Charge	$di/dt = 200\text{A}/\mu\text{s}$	$T_j = 25^\circ\text{C}$ $T_j = 125^\circ\text{C}$	1200 4000		



## Typical Performance Curve

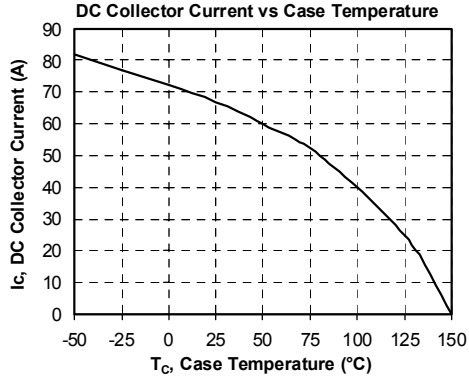
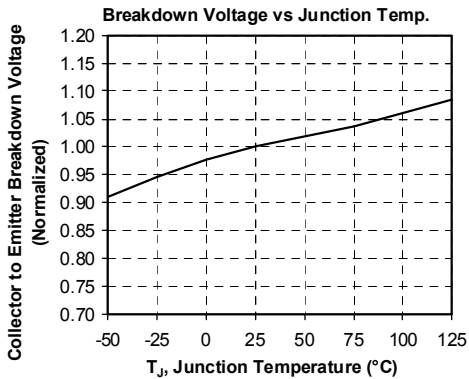
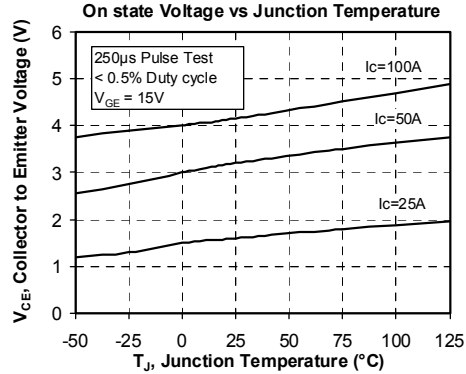
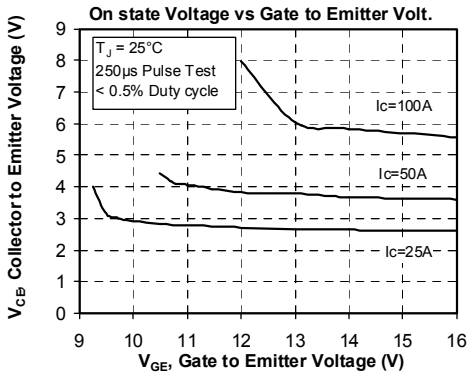
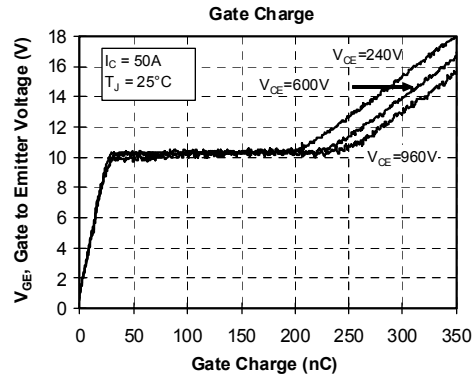
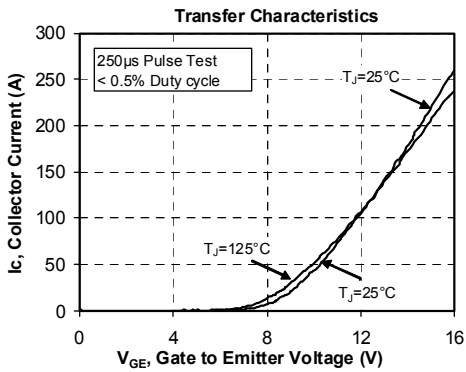
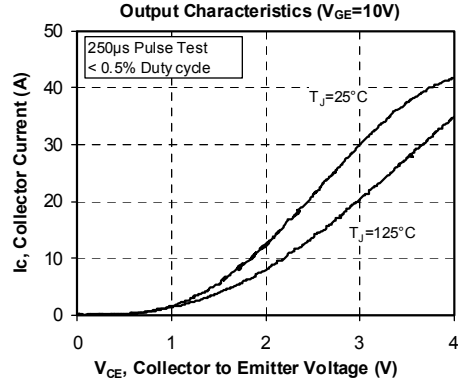
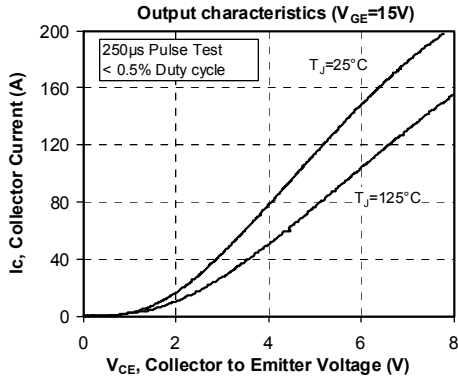

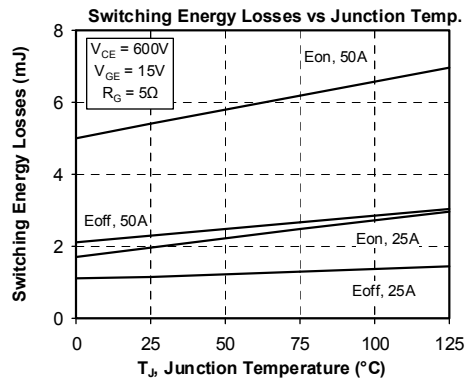
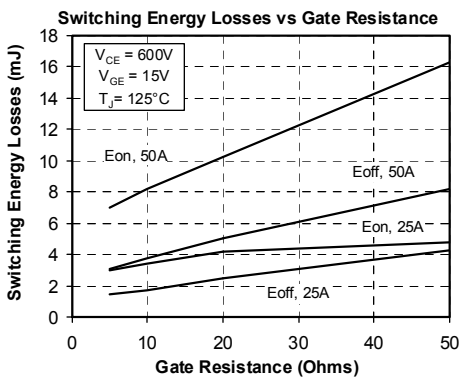
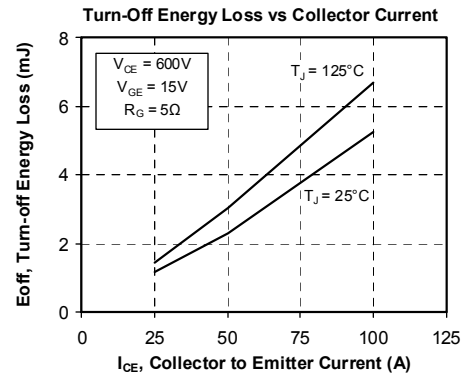
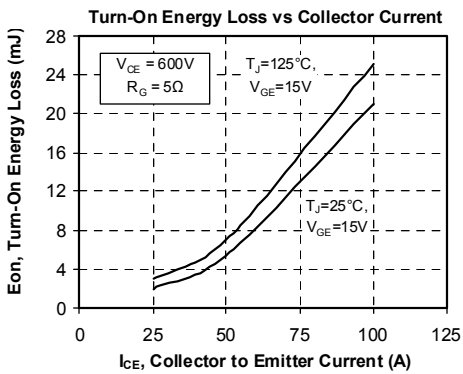
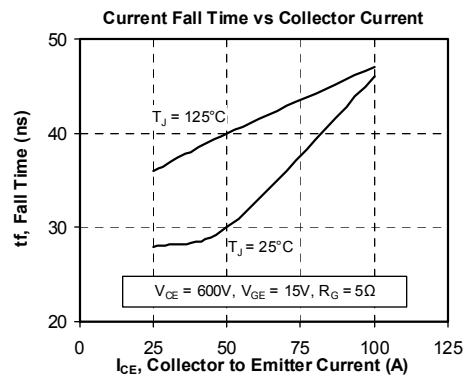
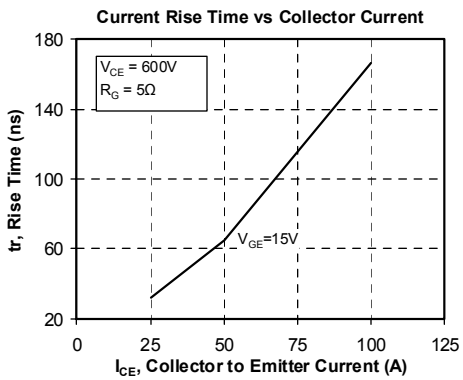
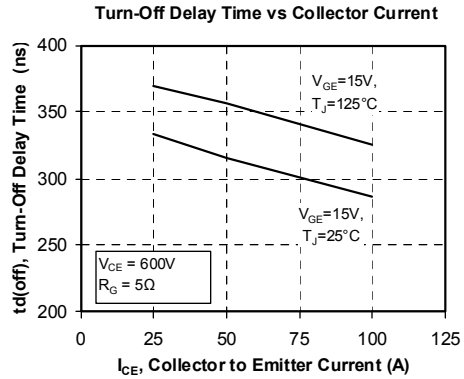
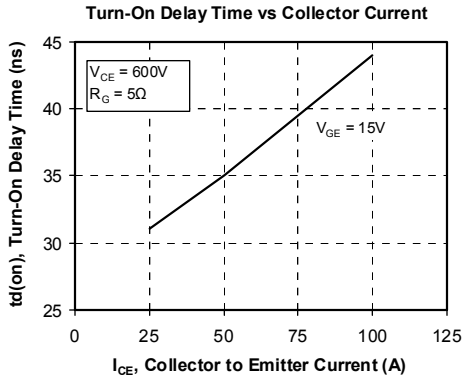

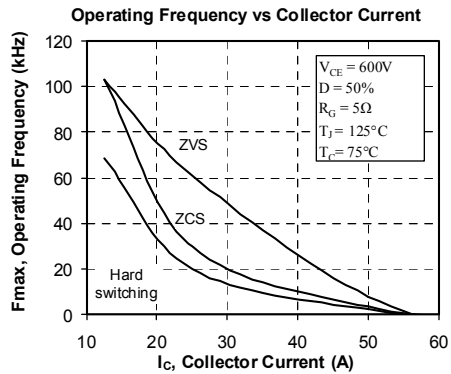
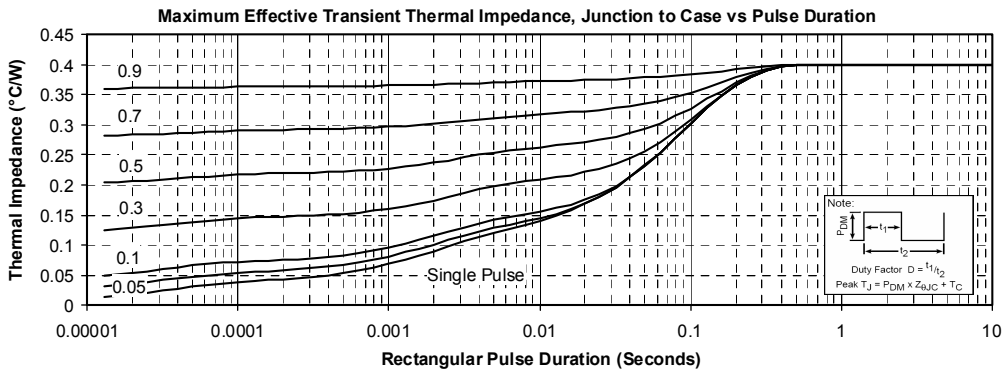
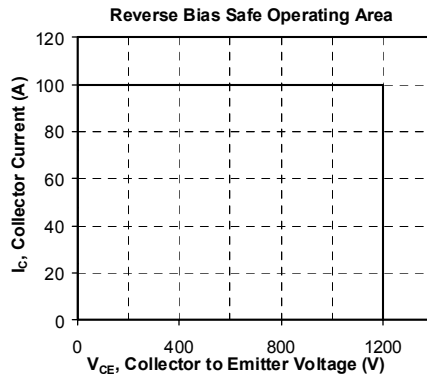
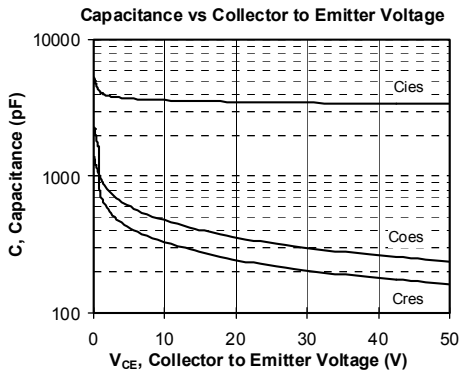

Microsemi reserves the right to change, without notice, the specifications and information contained herein

Microsemi's products are covered by one or more of U.S. patents 4,895,810 5,045,903 5,089,434 5,182,234 5,019,522 5,262,336 6,503,786 5,256,583 4,748,103 5,283,202 5,231,474 5,434,095 5,528,058 and foreign patents. U.S. and Foreign patents pending. All Rights Reserved.