

High Voltage Hall Effect Latch

■ Features

- On-chip Hall plate
- Operating voltage: 4V~28V
- Output current: 400mA(Continuous, 25°C)
- Reverse protection diode only for chip reverse power connecting ^(Note)
- Output protection Zener breakdown Vz=62V(Typ)
- Package: SIP-4L

(Note)

Protection diode only exists at power pin(1,4) output, not including pin (2,3).

■ Application

- Dual-coil Brush-less DC Motor
- Dual-coil Brush-less DC Fan
- Revolution Counting
- Speed Measurement

■ Pin Assignment

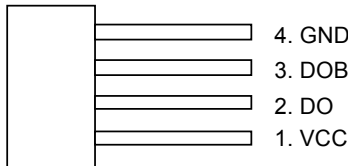

■ General Description

AH266 is an integrated Hall sensor with output drivers designed for electronic commutation of brush-less DC motor applications. The device includes an on-chip Hall voltage generator for magnetic sensing, a comparator that amplifies the Hall voltage, and a Schmitt trigger to provide switching hysteresis for noise rejection, and complementary darlington open-collector drivers for sinking large current loads. An internal bandgap regulator is used to provide temperature compensated supply voltage for internal circuits and allows a wide operating supply range.

If a magnetic flux density (B) is larger than operate point (Bop), DO turn on (low) and DOB turn off (high). The outputs state is latched prior to reach release point (Brp). if B < Brp, DO turn off and DOB turn on. AT266 is rated for operation over temperature range from -20°C to 85°C and voltage range from 4V to 28V. The devices are available in low cost die forms or rugged 4 pin SIP packages.

■ Pin Configuration

Name	Description
VCC	Positive Power Supply
DO	Output Pin
DOB	Output Pin
GND	Ground

■ Ordering Information

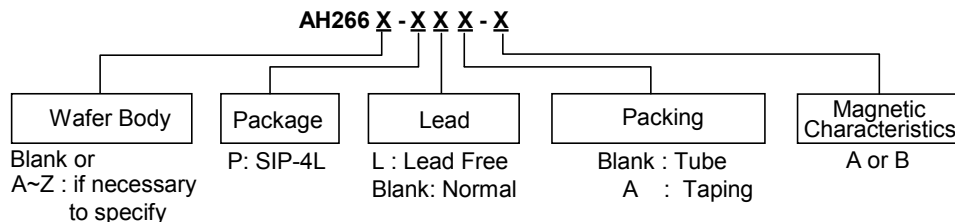

■ Block Diagram

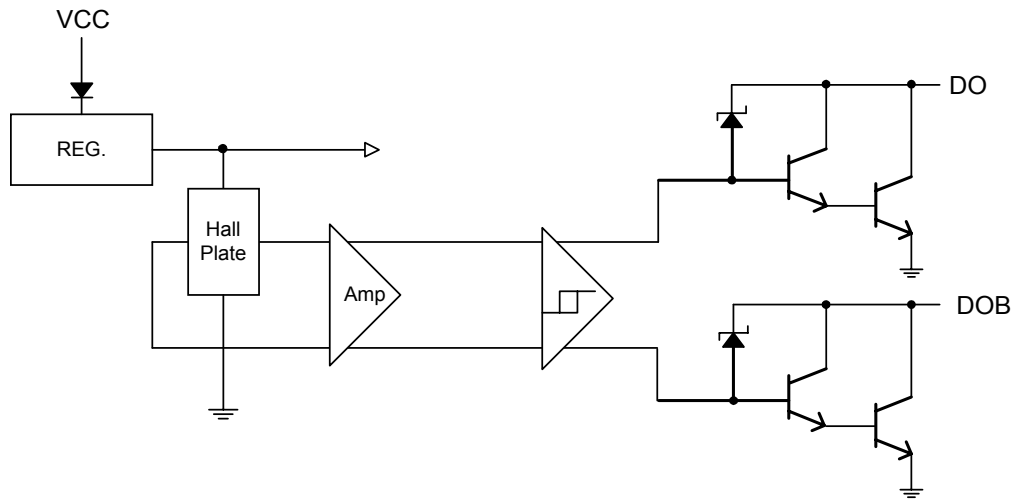

■ Application Circuit

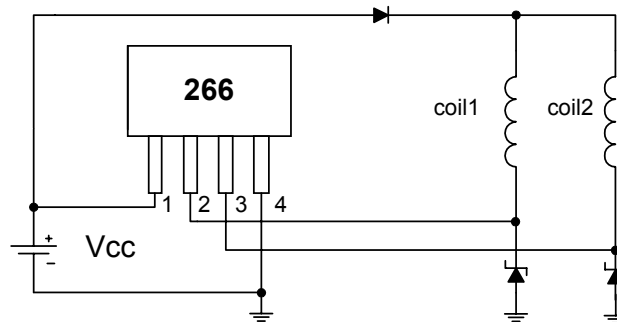

Brush-less DC Fan

Note: This application circuit can't protect reverse coil current if power is connecting reverse.

High Voltage Hall Effect Latch

■ Magnetic Characteristics (Ta=+25°C)

(1mT = 10 Gauss)

A grade

Characteristic	Symbol	Min.	Typ.	Max.	Unit
Operate Point	Bop	10	-	70	Gauss
Release Point	Brp	-70	-	-10	Gauss
Hysteresis	Bhy	-	80	-	Gauss

B grade

Characteristic	Symbol	Min.	Typ.	Max.	Unit
Operate Point	Bop	-	-	100	Gauss
Release Point	Brp	-100	-	-	Gauss
Hysteresis	Bhy	-	80	-	Gauss

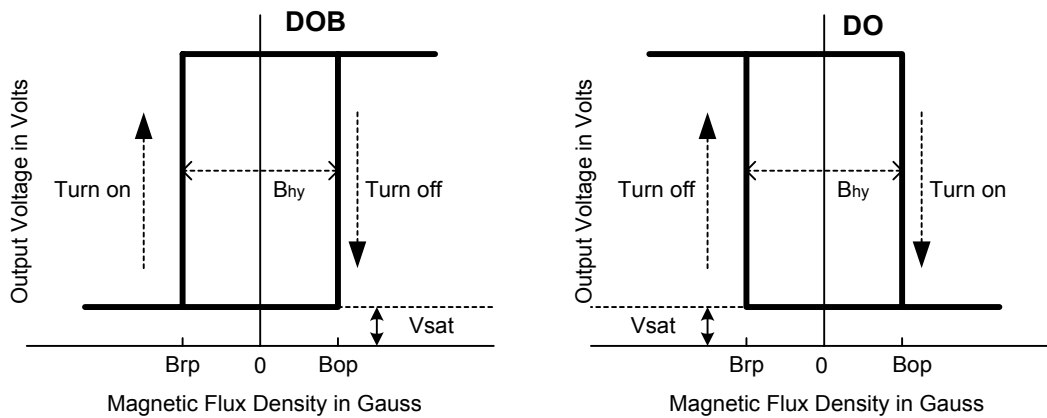

■ Performance Characteristics (SIP-4L)

Ta (°C)	25	50	60	70	80	85	90	95	100	105	110	115	120
Pd (mW)	550	440	396	352	308	286	264	242	220	198	176	154	132

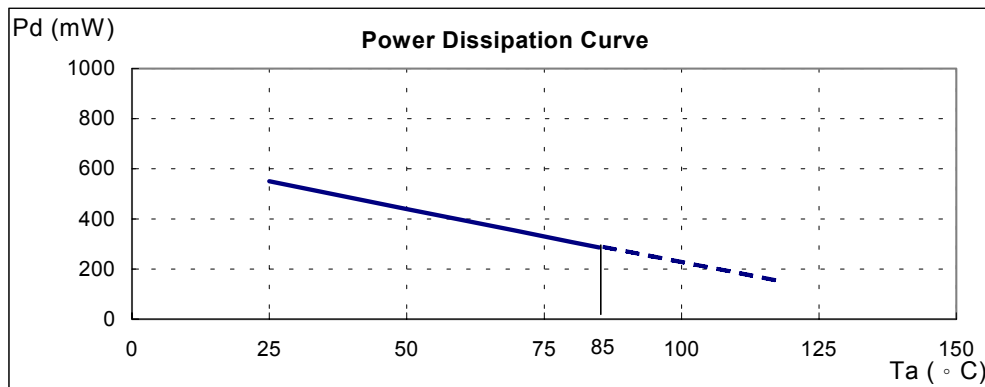

■ Operation Characteristics

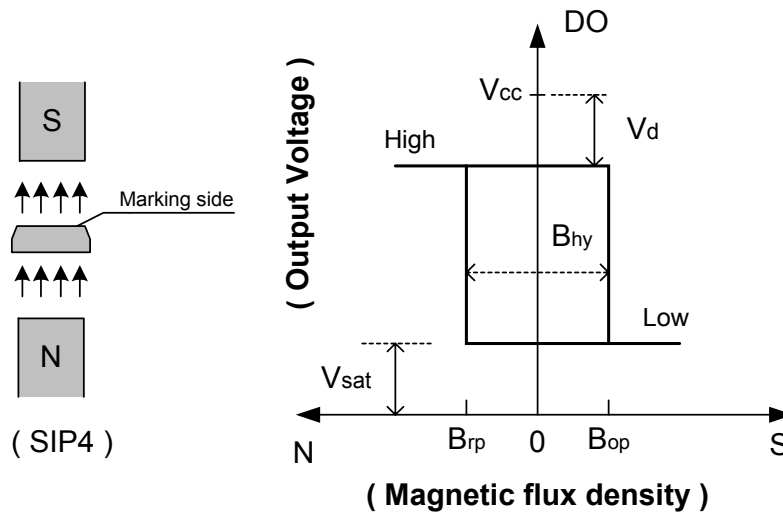

■ Marking Information

