



8ETL06PbF 8ETL06FPPbF

Ultra-low V_F Hyperfast Rectifier for Discontinuous Mode PFC

Features

- Benchmark Ultra-low Forward Voltage Drop
- Hyperfast Recovery Time
- Low Leakage Current
- 175°C Operating Junction Temperature
- Fully Isolated package ($V_{INS} = 2500 V_{RMS}$)
- UL E78996 approved 
- Lead-Free ("PbF" suffix)

$V_F = 0.96V$ typ.
 $I_{F(AV)} = 8Amp$
 $V_R = 600V$

Description

State of the art, ultra-low V_F , soft-switching Hyperfast Rectifiers optimized for Discontinuous (Critical) Mode (DCM) Power Factor Correction (PFC).

The minimised conduction loss, optimized stored charge and low recovery current minimize the switching losses and reduce over dissipation in the switching element and snubbers.

The device is also intended for use as a free wheeling diode in power supplies and other power switching applications.

Applications



AC-DC SMPS 70W-400W

e.g. Laptop & Printer AC Adaptors, Desktop PC, TV & Monitor, Games units and DVD AC-DC power supplies.

Absolute Maximum Ratings

Parameters	Max	Units
V_{RRM} Peak Repetitive Reverse Voltage	600	V
$I_{F(AV)}$ Average Rectified Forward Current @ $T_C = 160^\circ C$ @ $T_C = 142^\circ C$ (FULLPACK)	8	A
I_{FSM} Non Repetitive Peak Surge Current @ $T_J = 25^\circ C$	175	
I_{FM} Peak Repetitive Forward Current	16	
T_J, T_{STG} Operating Junction and Storage Temperatures	- 65 to 175	$^\circ C$

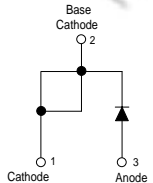
Case Styles

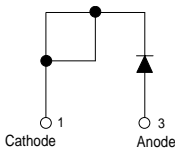
<p>8ETL06PbF</p>   <p>TO-220AC</p>	<p>8ETL06FPPbF</p>   <p>TO-220 FULLPACK</p>
------------------------------------------------------------------------------------------------------------------------------------------------------------------------------------------------------------------------	------------------------------------------------------------------------------------------------------------------------------------------------------------------------------------------------------------------------------------

Electrical Characteristics @ T_J = 25°C (unless otherwise specified)

Parameters	Min	Typ	Max	Units	Test Conditions
V _{BR} , V _F Breakdown Voltage, Blocking Voltage	600	-	-	V	I _R = 100μA
V _F Forward Voltage	-	0.96	1.05	V	I _F = 8A, T _J = 25°C
	-	0.81	0.86	V	I _F = 8A, T _J = 150°C
I _R Reverse Leakage Current	-	0.05	5	μA	V _R = V _R Rated
	-	20	100	μA	T _J = 150°C, V _R = V _R Rated
C _T Junction Capacitance	-	17	-	pF	V _R = 600V
L _S Series Inductance	-	8.0	-	nH	Measured lead to lead 5mm from package

body

Dynamic Recovery Characteristics @ T_C = 25°C (unless otherwise specified)

Parameters	Min	Typ	Max	Units	Test Conditions
t _{rr} Reverse Recovery Time	-	60	100	ns	I _F = 1A, di _F /dt = 100A/μs, V _R = 30V
	-	150	250		I _F = 8A, di _F /dt = 100A/μs, V _R = 30V
	-	170	-		T _J = 25°C
	-	250	-		T _J = 125°C
I _{RRM} Peak Recovery Current	-	15	-	A	T _J = 25°C
	-	20	-		T _J = 125°C
Q _{rr} Reverse Recovery Charge	-	1.3	-	μC	T _J = 25°C
	-	2.6	-		T _J = 125°C

I_F = 8A
di_F/dt = 200A/μs
V_R = 390V

Thermal - Mechanical Characteristics

Parameters	Min	Typ	Max	Units
T _J Max. Junction Temperature Range	-	-	175	°C
T _{Stg} Max. Storage Temperature Range	- 65	-	175	
R _{thJC} Thermal Resistance, Junction to Case	-	1.4	2	°C/W
	-	3.4	4.3	
R _{thJA} ^① Thermal Resistance, Junction to Ambient	-	-	70	°C/W
R _{thCS} ^② Thermal Resistance, Case to Heatsink	-	0.5	-	
Weight	-	2.0	-	g
	-	0.07	-	(oz)
Mounting Torque	6.0	-	12	Kg-cm
	5.0	-	10	lbf.in

① Typical Socket Mount

② Mounting Surface, Flat, Smooth and Greased

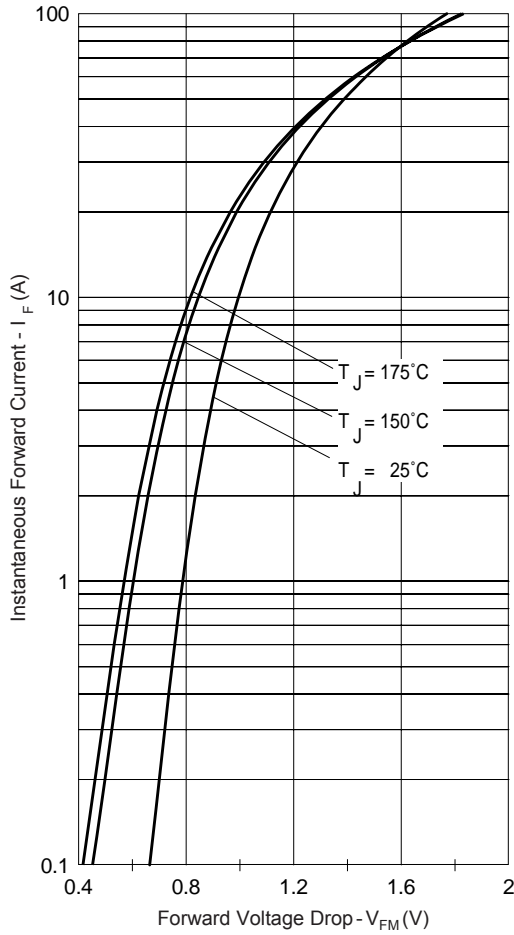

Fig. 1 - Typical Forward Voltage Drop Characteristics

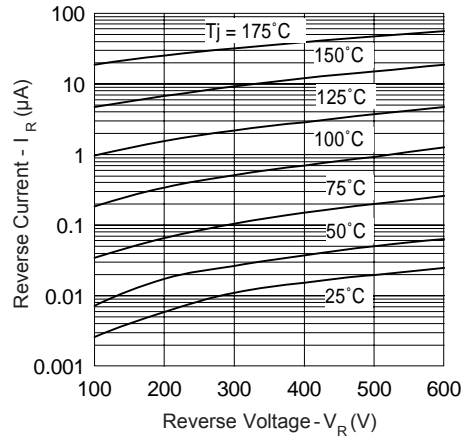

Fig. 2 - Typical Values Of Reverse Current Vs. Reverse Voltage

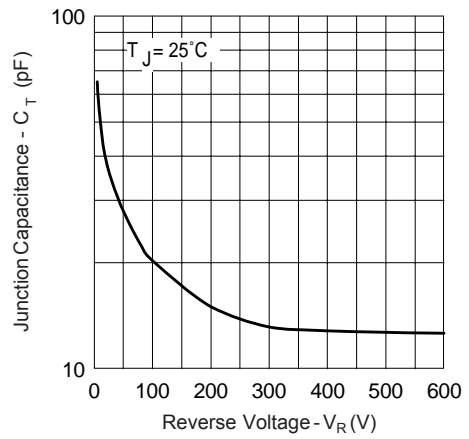

Fig. 3 - Typical Junction Capacitance Vs. Reverse Voltage

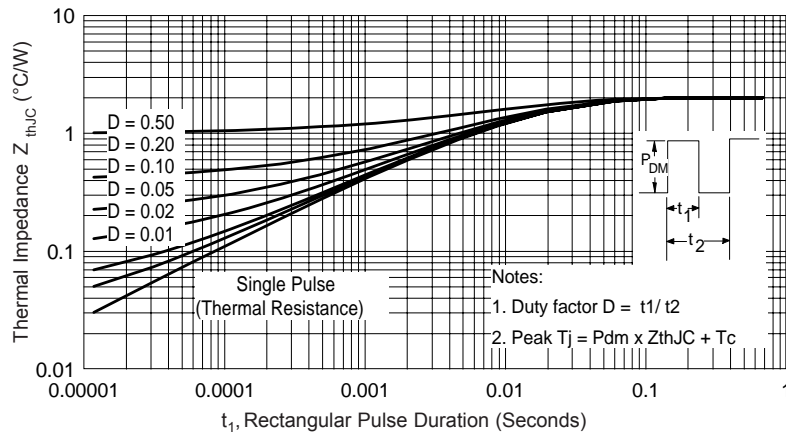

Fig. 4 - Max. Thermal Impedance Z_{thJC} Characteristics

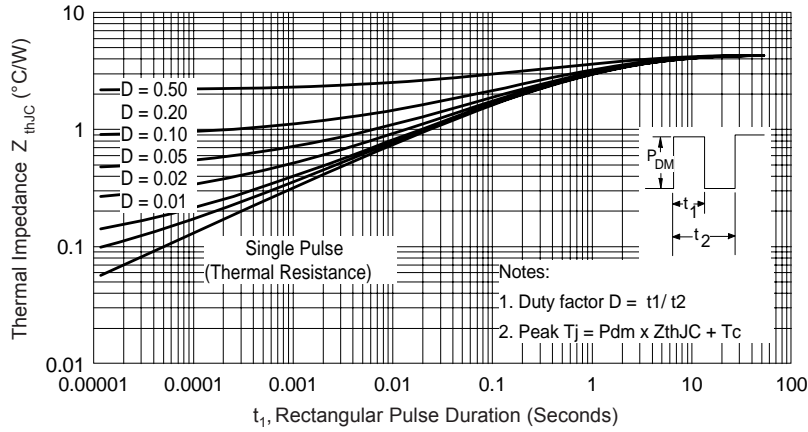

Fig. 5 - Max. Thermal Impedance Z_{thJC} Characteristics (FULLPACK)

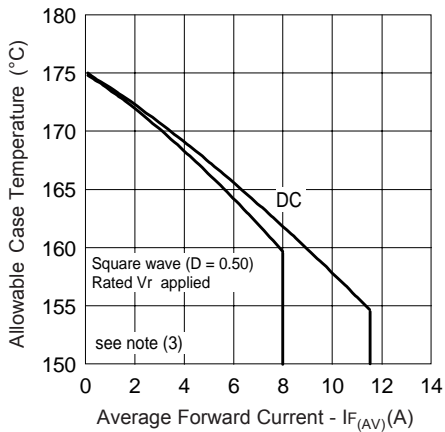

Fig. 6 - Max. Allowable Case Temperature Vs. Average Forward Current

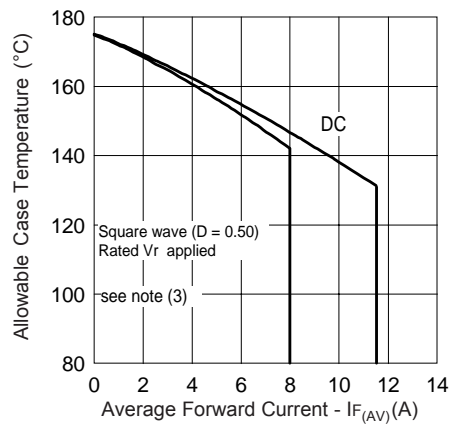

Fig. 7 - Max. Allowable Case Temperature Vs. Average Forward Current (FULLPACK)

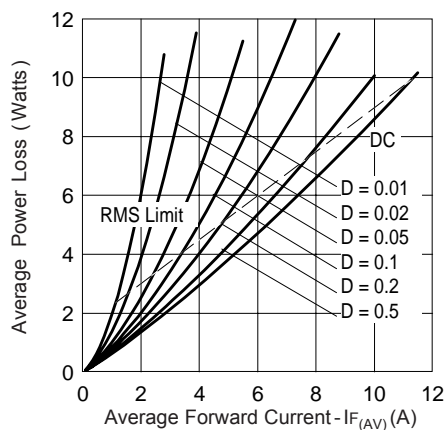

Fig. 8 - Forward Power Loss Characteristics

(3) Formula used: $T_C = T_J - (Pd + Pd_{REV}) \times R_{thJC}$;
 Pd = Forward Power Loss =
 $I_{F(AV)} \times V_{FM} @ (I_{F(AV)}/D)$
 (see Fig. 8);
 Pd_{REV} = Inverse Power Loss = $V_{R1} \times I_R (1 - D)$;
 $I_R @ V_{R1}$ = rated V_R

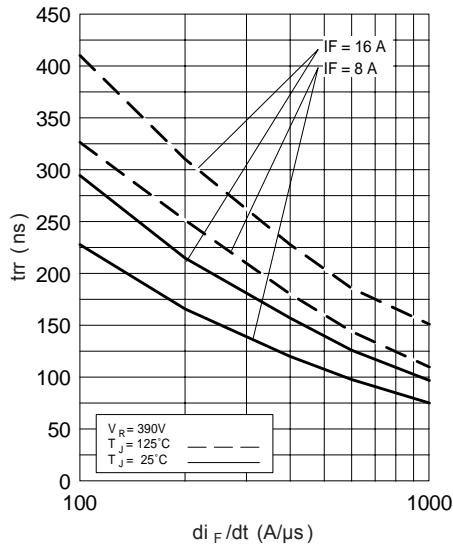

Fig. 9 - Typical Reverse Recovery vs. di_F/dt

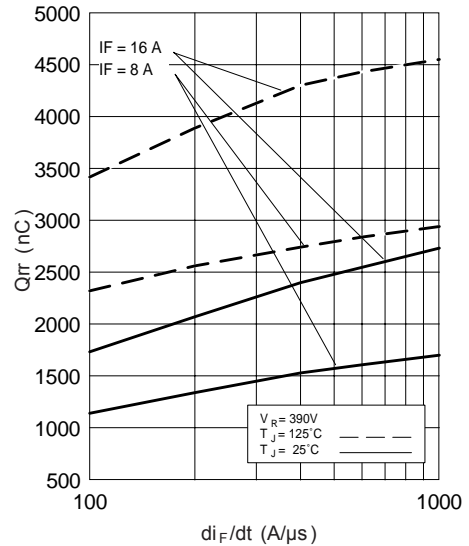

Fig. 10 - Typical Stored Charge vs. di_F/dt

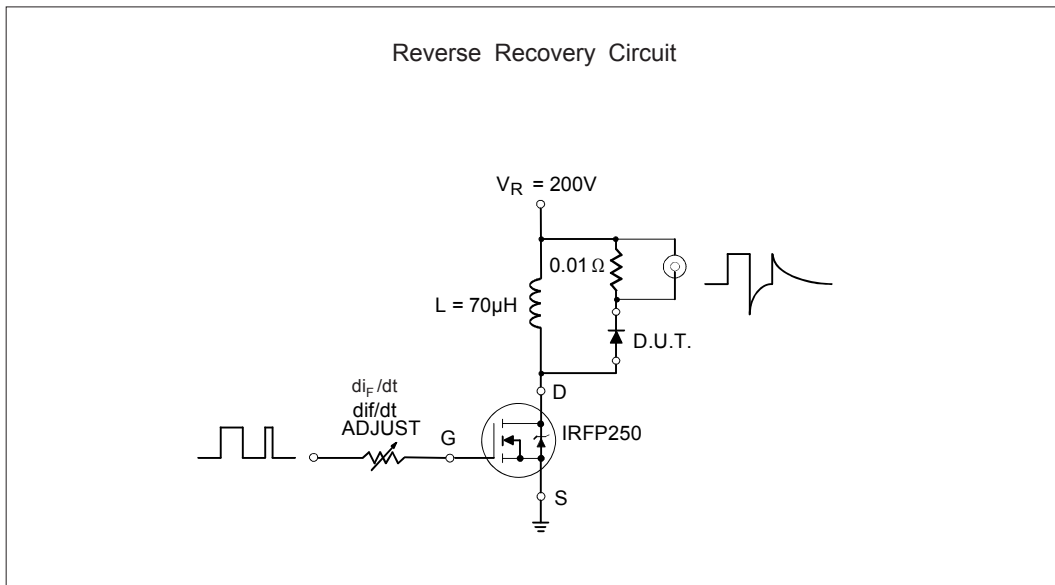

Fig. 11 - Reverse Recovery Parameter Test Circuit

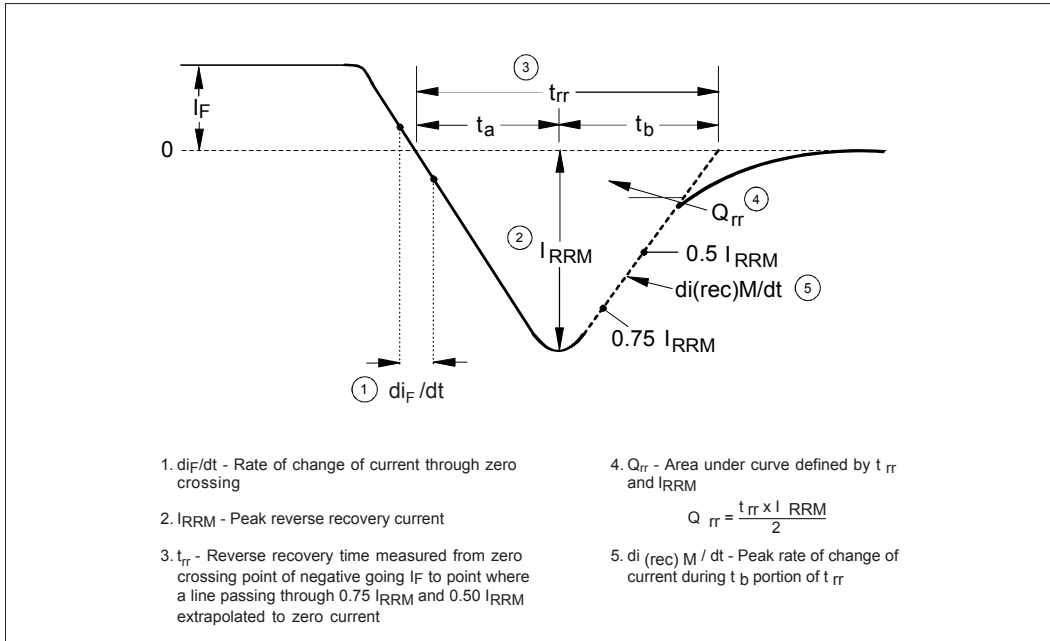
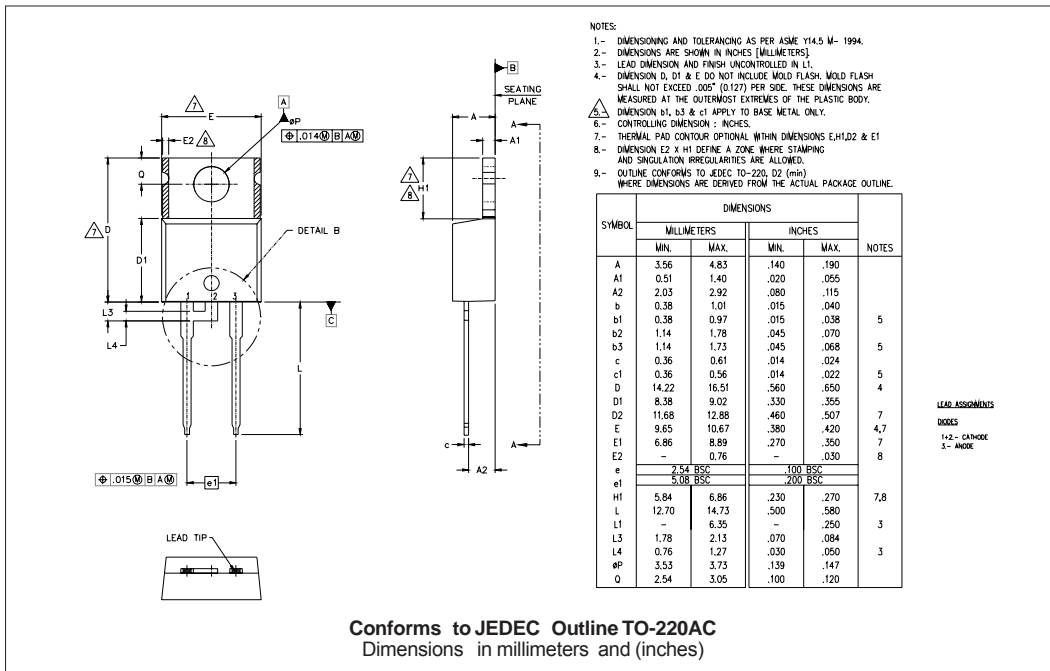
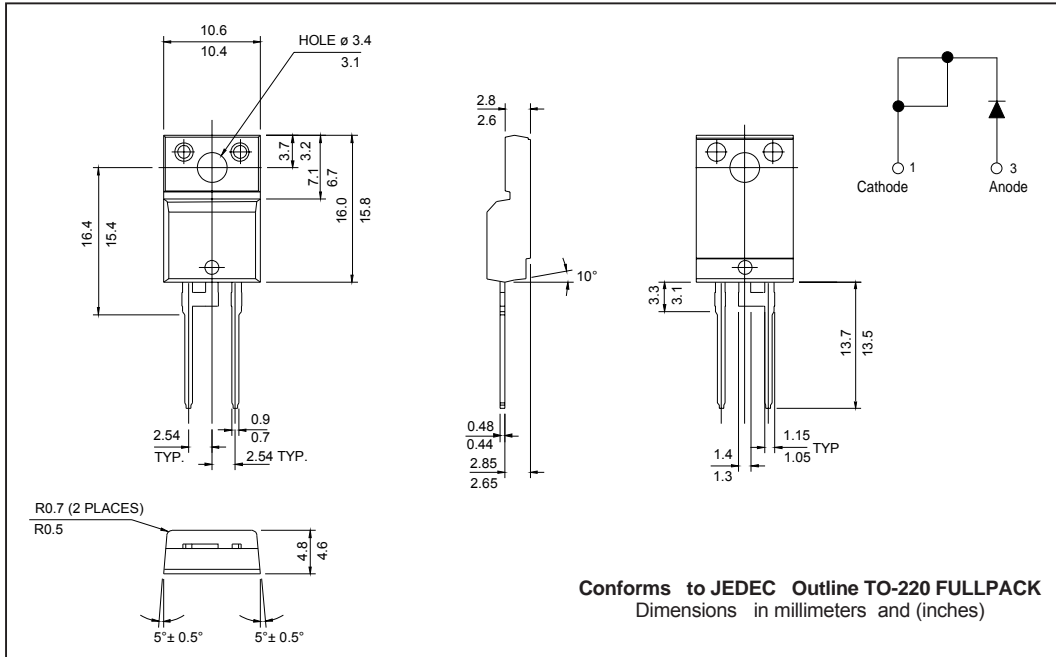

Fig. 12 - Reverse Recovery Waveform and Definitions

Outline Table



Outline Table



Part Marking Information (TO-220)

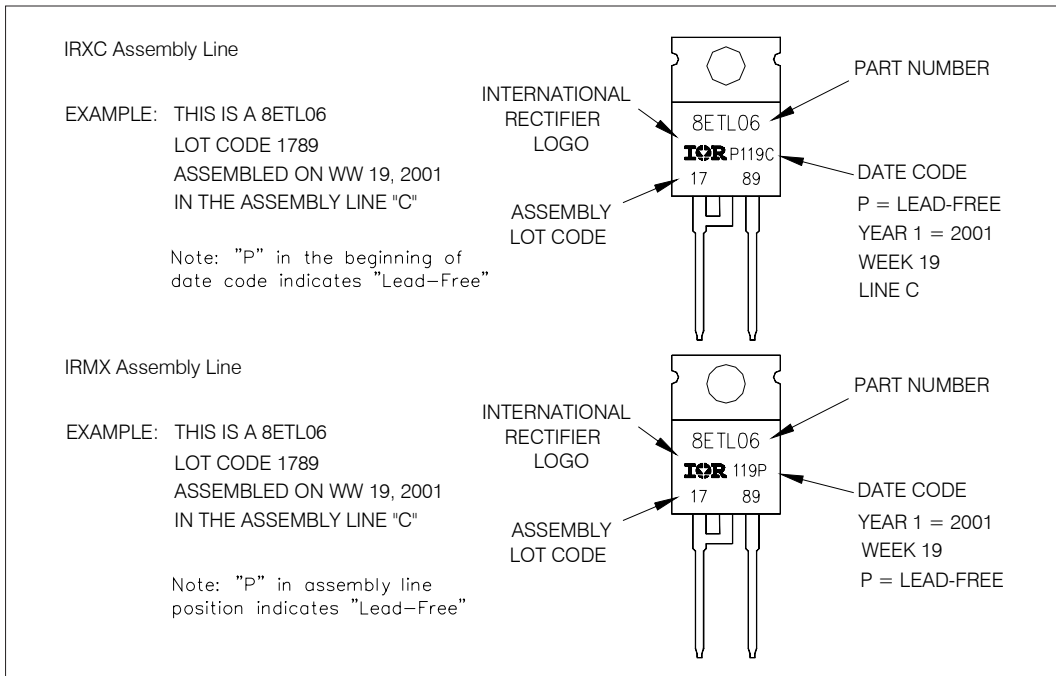

Part Marking Information (TO-220 FULL-PAK)

EXAMPLE: THIS IS A 8ETL06FP
 LOT CODE 1789
 ASSEMBLED ON WW 19, 2002
 IN THE ASSEMBLY LINE "C"

Note: "P" in assembly line position indicates "Lead-Free"

INTERNATIONAL RECTIFIER LOGO

ASSEMBLY LOT CODE

PART NUMBER
FP = Fullpack

DATE CODE
YEAR = 2002
WEEK 19
P = Lead-Free

Ordering Information Table

Device Code						
8	E	T	L	06	FP	PbF
①	②	③	④	⑤	⑥	⑦

1	- Current Rating (8 = 8A)
2	- E = Single Diode
3	- T = TO-220, D ² Pak
4	- L = Ultra-low V _F HyperFast Recovery
5	- Voltage Rating (06 = 600V)
6	- • none = TO-220AC • FP = TO-220 FULLPACK
7	- • none = Standard Production • PbF = Lead-Free

Tube Standard Pack Quantity: 50 pieces

Data and specifications subject to change without notice.
 This product has been designed and qualified for Industrial Level and Lead-Free.
 Qualification Standards can be found on IR's Web site.