

Features

- N channel
- Logic level
- Enhancement mode
- Temperature sensor with thyristor characteristic
- The drain pin is electrically shorted to the tab

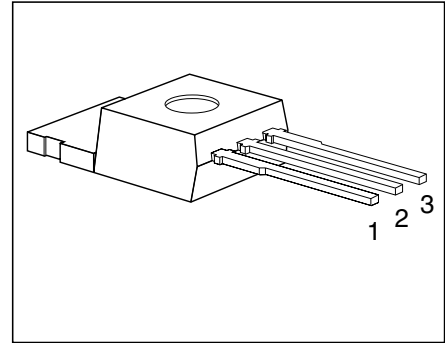

| Pin | 1 | 2 | 3 |
|-----|---|---|---|
| | G | D | S |

| Type | V_{DS} | I_D | $R_{DS(on)}$ | Package | Ordering Code |
|----------|----------|--------|---------------|----------|-----------------|
| BTS 115A | 50 V | 15.5 A | 0.12 Ω | TO-220AB | C67078-S5004-A2 |

Maximum Ratings

| Parameter | Symbol | Values | Unit |
|--|----------------------|------------------|------------------|
| Drain-source voltage | V_{DS} | 50 | V |
| Drain-gate voltage, $R_{GS} = 20 \text{ k}\Omega$ | V_{DGR} | 50 | |
| Gate-source voltage | V_{GS} | ± 10 | |
| Continuous drain current, $T_C = 25 \text{ }^\circ\text{C}$ | I_D | 15.5 | A |
| ISO drain current $T_C = 85 \text{ }^\circ\text{C}$, $V_{GS} = 4.5 \text{ V}$, $V_{DS} = 0.5 \text{ V}$ | I_{D-ISO} | 3.2 | |
| Pulsed drain current, $T_C = 25 \text{ }^\circ\text{C}$ | $I_{D \text{ puls}}$ | 62 | |
| Short circuit current, $T_j = -55 \dots +150 \text{ }^\circ\text{C}$ | I_{SC} | 37 | |
| Short circuit dissipation, $T_j = -55 \dots +150 \text{ }^\circ\text{C}$ | P_{SCmax} | 550 | W |
| Power dissipation | P_{tot} | 50 | |
| Operating and storage temperature range | T_j, T_{stg} | $-55 \dots +150$ | $^\circ\text{C}$ |
| DIN humidity category, DIN 40 040 | – | E | |
| IEC climatic category, DIN IEC 68-1 | – | 55/150/56 | |
| Thermal resistance | | | K/W |
| Chip-case | $R_{th \text{ JC}}$ | ≤ 2.5 | |
| Chip-ambient | $R_{th \text{ JA}}$ | ≤ 75 | |

Electrical Characteristics

 at $T_j = 25\text{ °C}$, unless otherwise specified.

| Parameter | Symbol | Values | | | Unit |
|-----------|--------|--------|------|------|------|
| | | min. | typ. | max. | |

Static Characteristics

| | | | | | |
|---|---------------|-----------------------|------|------|---------------|
| Drain-source breakdown voltage $V_{GS} = 0, I_D = 0.25\text{ mA}$ | $V_{(BR)DSS}$ | 50 | – | – | V |
| Gate threshold voltage $V_{GS} = V_{DS}, I_D = 1.0\text{ mA}$ | $V_{GS(th)}$ | 1.5 | 2.0 | 2.5 | |
| Zero gate voltage drain current $V_{GS} = 0\text{ V}, V_{DS} = 50\text{ V}$ | I_{DSS} | | | | μA |
| | | $T_j = 25\text{ °C}$ | 0.1 | 1.0 | |
| | | $T_j = 125\text{ °C}$ | 10 | 100 | |
| Gate-source leakage current $V_{GS} = 20\text{ V}, V_{DS} = 0$ | I_{GSS} | | | | |
| | | $T_j = 25\text{ °C}$ | 10 | 100 | nA |
| | | $T_j = 150\text{ °C}$ | 2 | 4 | μA |
| Drain-source on-state resistance $V_{GS} = 4.5\text{ V}, I_D = 7.8\text{ A}$ | $R_{DS(on)}$ | – | 0.09 | 0.12 | Ω |

Dynamic Characteristics

| | | | | | |
|---|--------------|-----|-----|-----|----|
| Forward transconductance $V_{DS} \geq 2 \times I_D \times R_{DS(on)max}, I_D = 7.8\text{ A}$ | g_{fs} | 5.5 | 9.5 | – | S |
| Input capacitance $V_{GS} = 0, V_{DS} = 25\text{ V}, f = 1\text{ MHz}$ | C_{iss} | – | 550 | 735 | pF |
| Output capacitance $V_{GS} = 0, V_{DS} = 25\text{ V}, f = 1\text{ MHz}$ | C_{oss} | – | 220 | 320 | |
| Reverse transfer capacitance $V_{GS} = 0, V_{DS} = 25\text{ V}, f = 1\text{ MHz}$ | C_{rss} | – | 85 | 150 | |
| Turn-on time t_{on} , ($t_{on} = t_{d(on)} + t_r$) $V_{CC} = 30\text{ V}, V_{GS} = 5\text{ V}, I_D = 3\text{ A}, R_{GS} = 50\text{ }\Omega$ | $t_{d(on)}$ | – | 15 | 25 | ns |
| | t_r | – | 70 | 100 | |
| Turn-off time t_{off} , ($t_{off} = t_{d(off)} + t_f$) $V_{CC} = 30\text{ V}, V_{GS} = 10\text{ V}, I_D = 3\text{ A}, R_{GS} = 50\text{ }\Omega$ | $t_{d(off)}$ | – | 70 | 90 | |
| | t_f | – | 50 | 70 | |

Electrical Characteristics (cont'd)

 at $T_j = 25\text{ °C}$, unless otherwise specified.

| Parameter | Symbol | Values | | | Unit |
|-----------|--------|--------|------|------|------|
| | | min. | typ. | max. | |

Reverse Diode

| | | | | | |
|---|----------|---|------|------|---------------|
| Continuous source current | I_S | – | – | 15.5 | A |
| Pulsed source current | I_{SM} | – | – | 62 | |
| Diode forward on-voltage $I_F = 15.5\text{ A}$, $V_{GS} = 0\text{ V}$ | V_{SD} | – | 1.3 | 1.6 | V |
| Reverse recovery time $I_F = I_S$, $di_F/dt = 100\text{ A}/\mu\text{s}$, $V_R = 30\text{ V}$ | t_{rr} | – | 60 | – | ns |
| Reverse recovery charge $I_F = I_S$, $di_F/dt = 100\text{ A}/\mu\text{s}$, $V_R = 30\text{ V}$ | Q_{rr} | – | 0.10 | – | μC |

Temperature Sensor

| | | | | | |
|--|--------------|--------------|------------|------------|---------------|
| Forward voltage $I_{TS(on)} = 5.0\text{ mA}$, $T_j = -55 \dots +150\text{ °C}$ Sensor override, $t_p \leq 100\text{ }\mu\text{s}$ $T_j = -55 \dots +160\text{ °C}$ | $V_{TS(on)}$ | | 1.3 | 1.4 | V |
| | | – | – | 10 | |
| Forward current $T_j = -55 \dots +150\text{ °C}$ Sensor override, $t_p \leq 100\text{ }\mu\text{s}$ $T_j = -55 \dots +160\text{ °C}$ | $I_{TS(on)}$ | – | – | 5 | mA |
| | | – | – | 600 | |
| Holding current, $V_{TS(off)} = 5\text{ V}$, $T_j = 25\text{ °C}$ $T_j = 150\text{ °C}$ | I_H | 0.05 0.05 | 0.1 0.2 | 0.5 0.3 | |
| Switching temperature $V_{TS} = 5\text{ V}$ | $T_{TS(on)}$ | 150 | – | – | °C |
| Turn-off time $V_{TS} = 5\text{ V}$, $I_{TS(on)} = 2\text{ mA}$ | t_{off} | 0.5 | – | 2.5 | μs |

Examples for short-circuit protection

 at $T_j = -55 \dots +150 \text{ }^\circ\text{C}$, unless otherwise specified.

| Parameter | Symbol | Examples | | | Unit |
|---|---------------|----------|-----|---|------|
| | | 1 | 2 | – | |
| Drain-source voltage | V_{DS} | 15 | 30 | – | V |
| Gate-source voltage | V_{GS} | 5.0 | 3.5 | – | |
| Short-circuit current | I_{SC} | 37 | 17 | – | A |
| Short-circuit dissipation | P_{SC} | 550 | 510 | – | W |
| Response time $T_j = 25 \text{ }^\circ\text{C}$, before short circuit | $t_{SC(off)}$ | 25 | 25 | – | ms |

Short-circuit protection $I_{SC} = f(V_{DS})$

 Parameter: V_{GS}

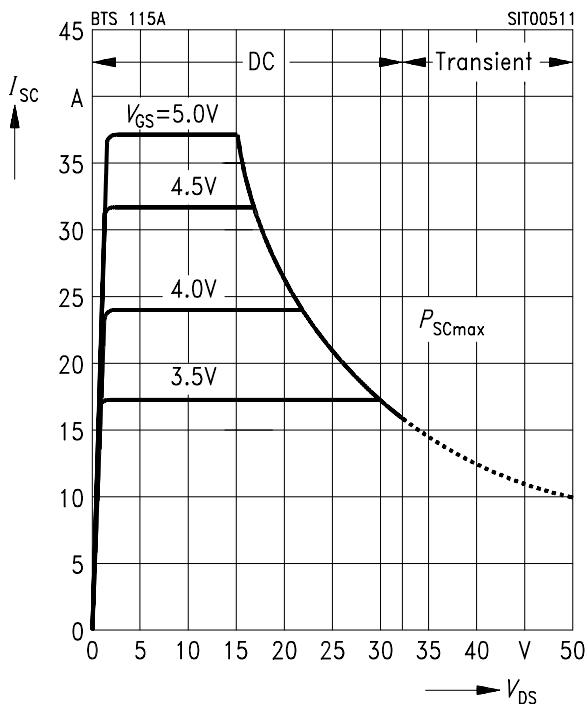
 Diagram to determine I_{SC} for $T_j = -55 \dots +150 \text{ }^\circ\text{C}$

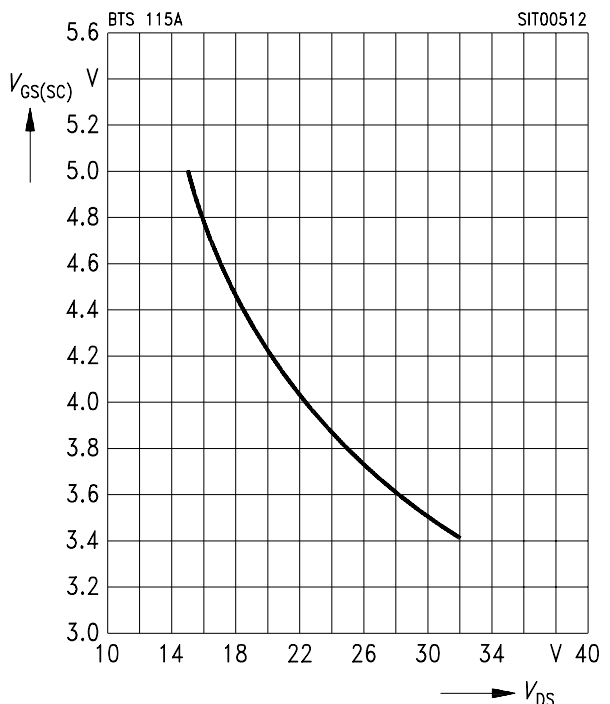
Max. gate voltage $V_{GS(SC)} = f(V_{DS})$

 Parameter: $T_j = -55 \dots +150 \text{ }^\circ\text{C}$

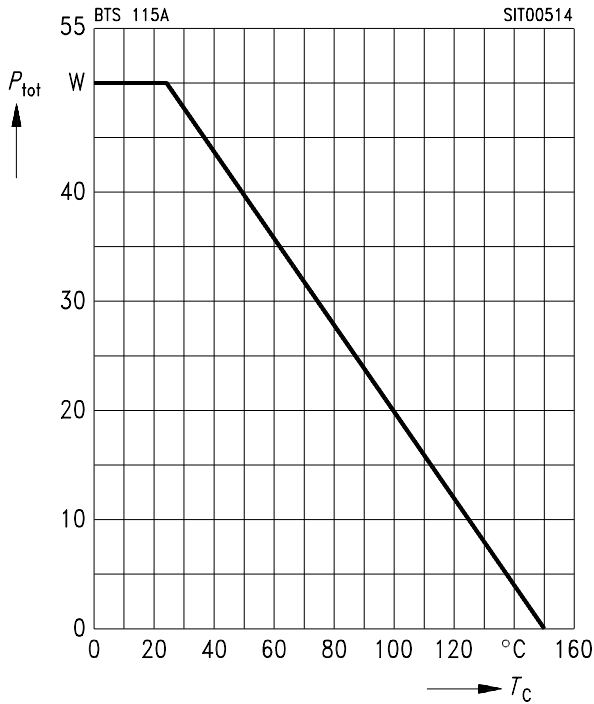
Max. power dissipation $P_{tot} = f(T_C)$



Typ. drain-source on-state resistance $R_{DS(on)} = f(I_D)$

Parameter: V_{GS}

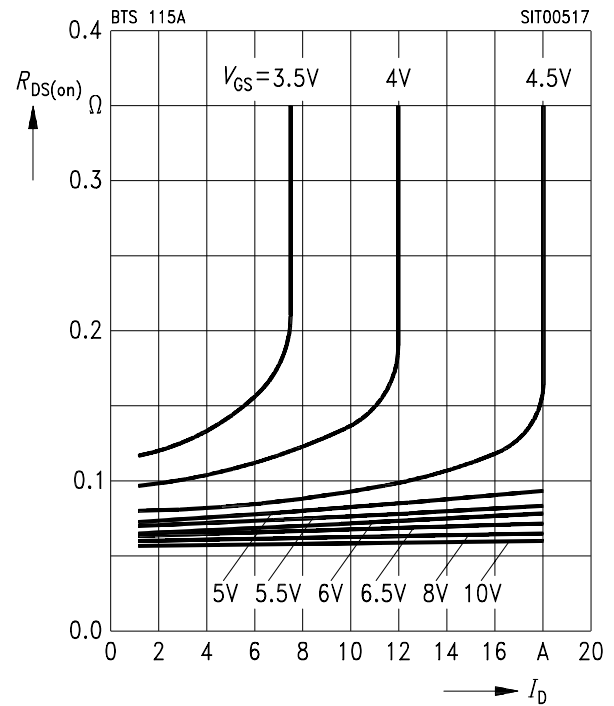

Typical output characteristics $I_D = f(V_{DS})$

Parameter: $t_p = 80 \mu s$

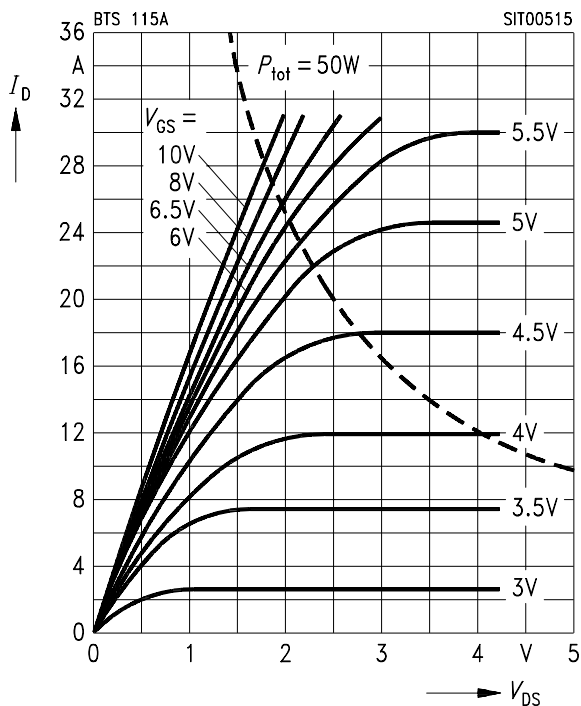

Safe operating area $I_D = f(V_{DS})$

Parameter: $D = 0.01$, $T_C = 25^\circ C$

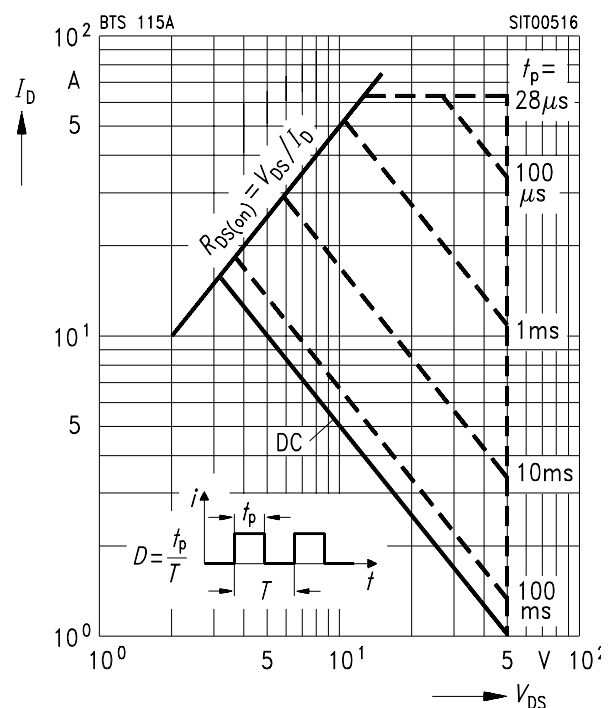

Drain-source on-state resistance

$R_{DS(on)} = f(T_j)$

Parameter: $I_D = 7.8 \text{ A}$, $V_{GS} = 4.5 \text{ V}$

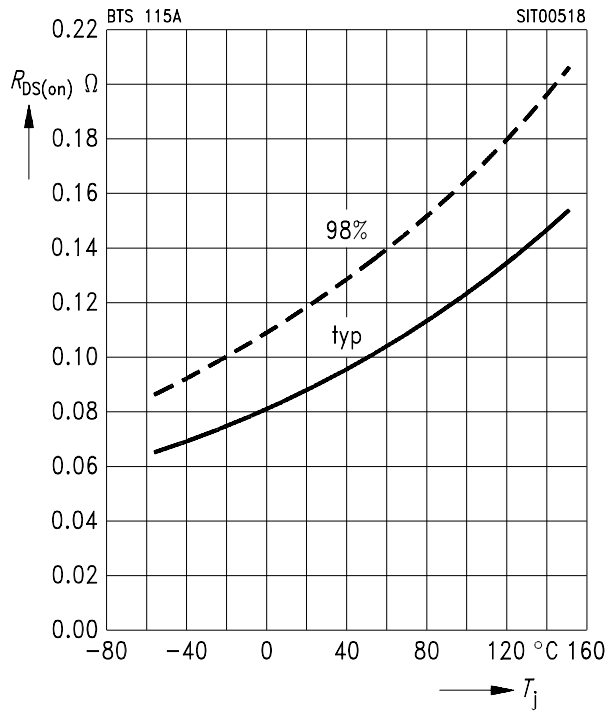

Gate threshold voltage $V_{GS(th)} = f(T_j)$

Parameter: $V_{DS} = V_{GS}$, $I_D = -1 \text{ mA}$

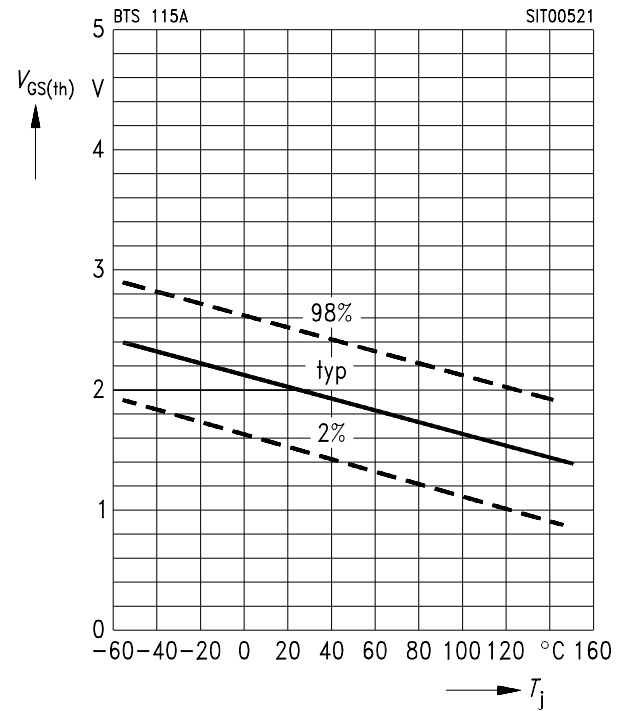

Typ. transfer characteristic

$I_D = f(V_{GS})$

Parameter: $t_p = 80 \mu\text{s}$, $V_{DS} = -25 \text{ V}$

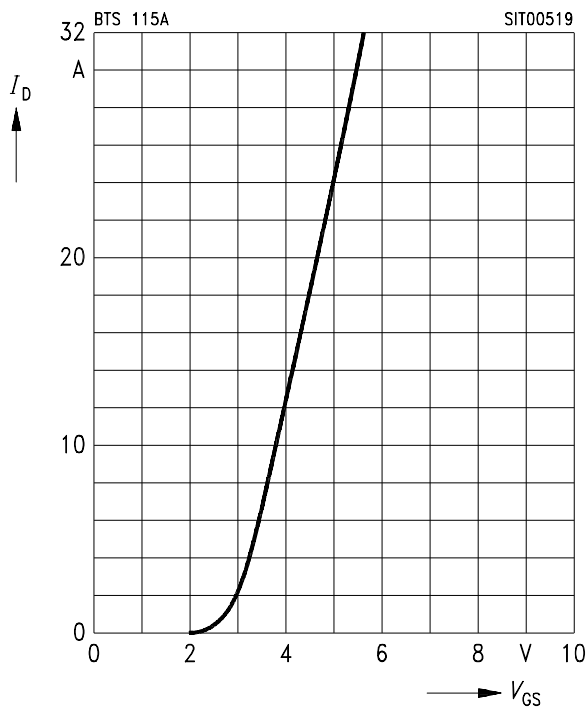

Typ. transconductance $g_{fs} = f(I_D)$

Parameter: $t_p = 80 \mu\text{s}$, $V_{DS} = -25 \text{ V}$

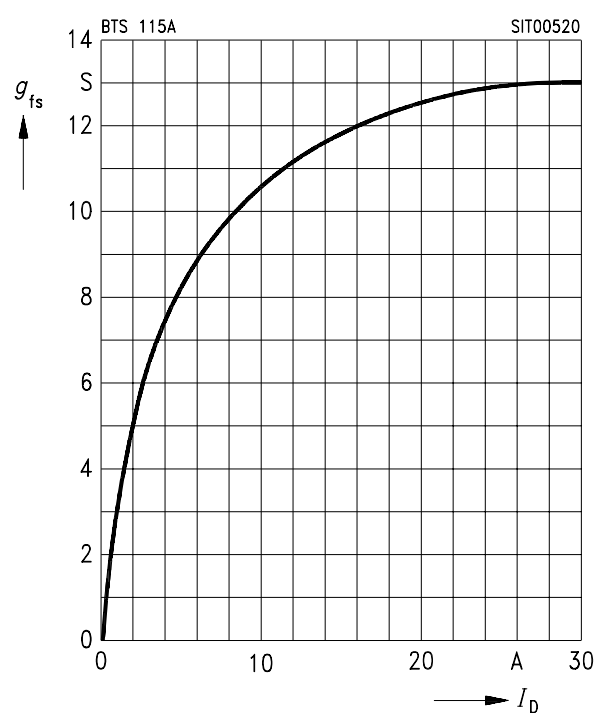

Continuous drain current $I_D = f(T_C)$

Parameter: $V_{GS} \geq 4.5 \text{ V}$

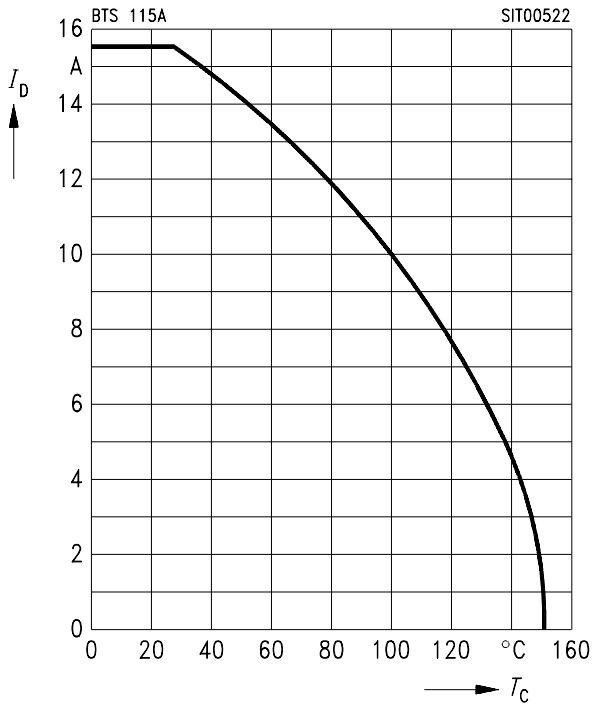

Forward characteristics of reverse diode $I_F = f(V_{SD})$

Parameter: $T_j, t_p = 80 \mu\text{s}$

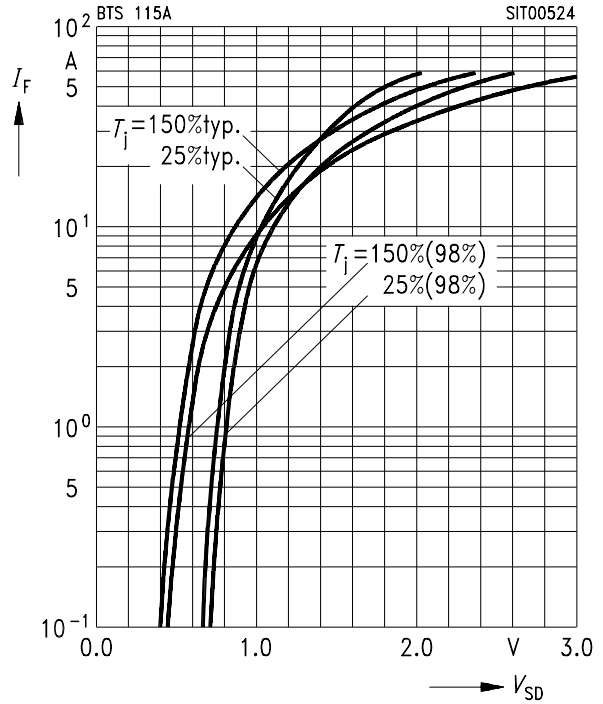

Typ. gate-source leakage current $I_{GSS} = f(T_C)$

Parameter: $V_{GS} = -20 \text{ V}, V_{DS} = 0$

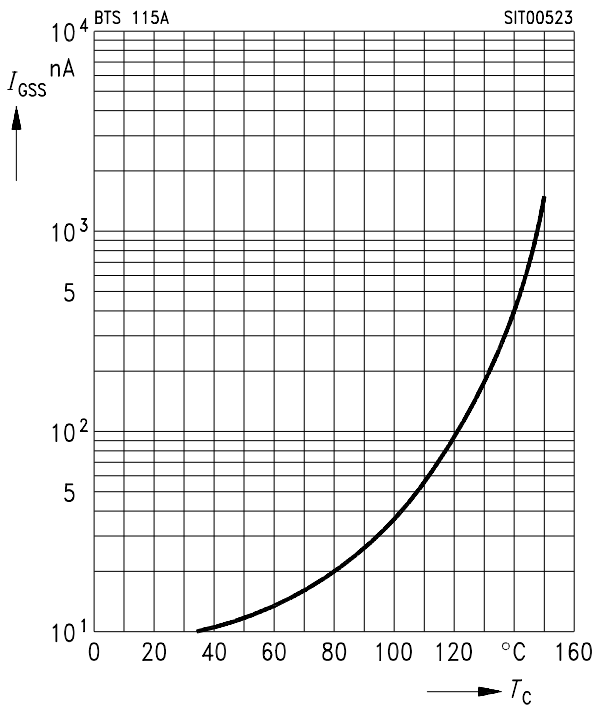

Typ. capacitances $C = f(V_{DS})$

Parameter: $V_{GS} = 0, f = 1 \text{ MHz}$

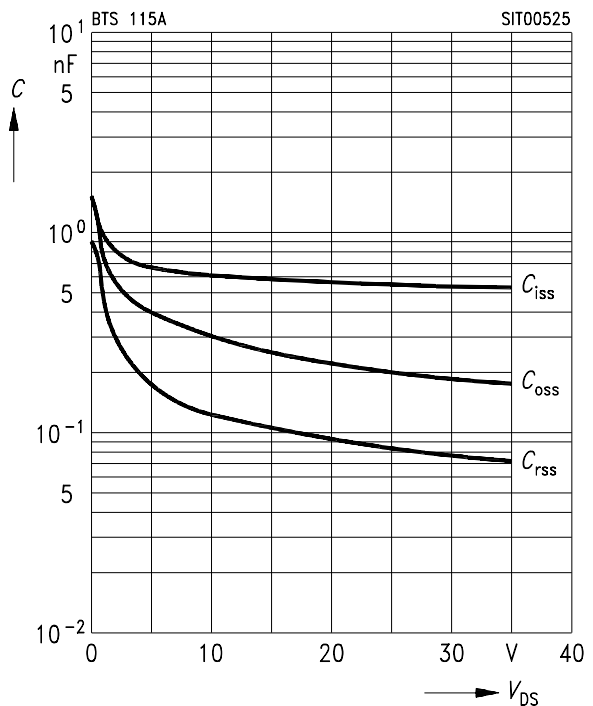

Transient thermal impedance $Z_{thJC} = f(t_p)$
 Parameter: $D = t_p/T$

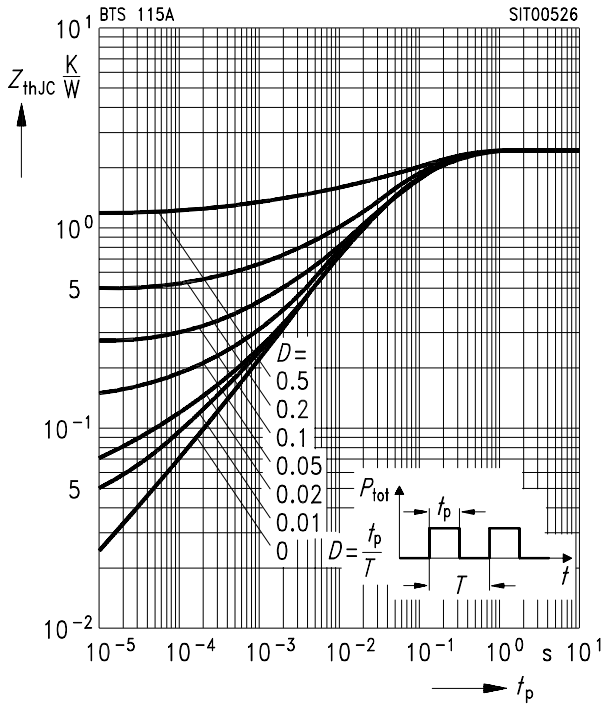

TO 220 AB
Standard

Ordering Code
C67078-S5004-A2

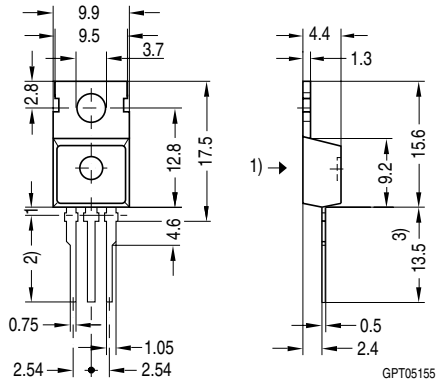

- 1) punch direction, burr max. 0.04
- 2) dip tinning
- 3) max. 14.5 by dip tinning press burr max. 0.05

GPT05155

TO 220 AB
SMD Version E 3045

Ordering Code
C67078-S5004-A8

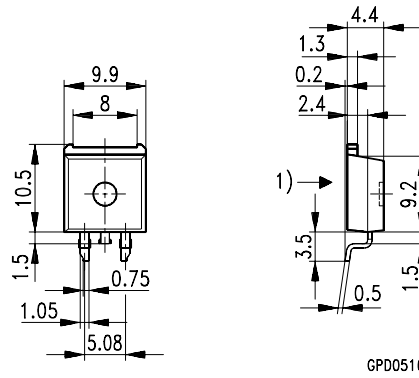

- 1) shear and punch direction no burrs this surface

GPD05164

Edition 04.97

**Published by Infineon Technologies AG,
St.-Martin-Strasse 53,
D-81541 München, Germany**

**© Infineon Technologies AG 2000.
All Rights Reserved.**

Attention please!

The information herein is given to describe certain components and shall not be considered as warranted characteristics.

Terms of delivery and rights to technical change reserved.

We hereby disclaim any and all warranties, including but not limited to warranties of non-infringement, regarding circuits, descriptions and charts stated herein.

Infineon Technologies is an approved CECC manufacturer.

Information

For further information on technology, delivery terms and conditions and prices please contact your nearest Infineon Technologies Office in Germany or our Infineon Technologies Representatives worldwide (see address list).

Warnings

Due to technical requirements components may contain dangerous substances. For information on the types in question please contact your nearest Infineon Technologies Office.

Infineon Technologies Components may only be used in life-support devices or systems with the express written approval of Infineon Technologies, if a failure of such components can reasonably be expected to cause the failure of that life-support device or system, or to affect the safety or effectiveness of that device or system. Life support devices or systems are intended to be implanted in the human body, or to support and/or maintain and sustain and/or protect human life. If they fail, it is reasonable to assume that the health of the user or other persons may be endangered.