

Bias Resistor Transistor NPN Silicon

(Pb) Lead(Pb)-Free

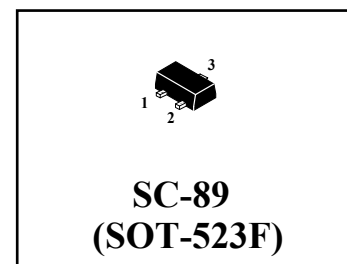
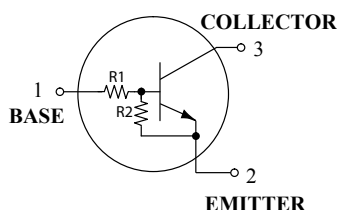

Maximum Ratings (TA=25°C unless otherwise noted)

Rating	Symbol	Value	Unit
Collector-Emitter Voltage	V _{CEO}	50	V
Collector-Base Voltage	V _{CBO}	50	V
Collector Current-Continuous	I _C	100	mA

Thermal Characteristics

Characteristics	Symbol	Max	Unit
Total Device Dissipation FR-5 Board FR-4 Board ⁽¹⁾ T _A =25°C Derate above 25°C	P _D	200 1.6	mW mW/°C
Thermal Resistance, Junction to Ambient ⁽¹⁾	R _{θJA}	600	°C/W
Total Device Dissipation FR-5 Board FR-4 Board ⁽²⁾ T _A =25°C Derate above 25°C	P _D	300 2.4	mW mW/°C
Thermal Resistance, Junction to Ambient ⁽²⁾	R _{θJA}	400	°C/W
Junction Temperature Range	T _J	-55 to +150	°C
Storage Temperature Range	T _{stg}	-55 to +150	°C

1.FR-4 @ Minimum pad

2.FR-4 @1.0 x 1.0 Inch pad

Device Marking and Resistor Values

Device	Marking	R1(K)	R2(K)
DTC114EE	8A	10	10
DTC124EE	8B	22	22
DTC144EE	8C	47	47
DTC114YE	8D	10	47
DTC114TE	94	10	∞
DTC143TE	8F	4.7	∞

Device	Marking	R1(K)	R2(K)
DTC123EE	8H	2.2	2.2
DTC143EE	8J	4.7	4.7
DTC143ZE	8K	4.7	47
DTC124XE	8L	22	47
DTC123JE	8M	2.2	47
DTC115EE	8N	100	100
DTC144WE	8P	47	22

Electrical Characteristics (T_A=25°C Unless Otherwise noted)

Characteristics	Symbol	Min	Typ	Max	Unit
-----------------	--------	-----	-----	-----	------

Off Characteristics

Collector-Emitter Breakdown Voltage ⁽²⁾ I _C =2.0mA, I _B =0	V _{(BR)CEO}	50	-	-	V	
Collector-Base Breakdown Voltage I _C =10μA, I _E =0	V _{(BR)CBO}	50	-	-	V	
Collector-Base Cutoff Voltage V _{CB} =50V, I _E =0	I _{CBO}	-	-	100	nA	
Collector-Emitter Cutoff Current V _{CE} =50V, I _B =0	I _{CEO}	-	-	500	nA	
Emitter-Base Cutoff Current V _{EB} =6.0V, I _C =0	DTC114EE DTC124EE DTC144EE DTC114YE DTC114TE DTC143TE DTC123EE DTC143EE DTC143ZE DTC124XE DTC123JE DTC115EE DTC144WE	I _{EBO}	- - - - - - - - - - - - -	- - - - - - - - - - - - -	0.5 0.2 0.1 0.2 0.9 1.9 2.3 1.5 0.18 0.13 0.2 0.05 0.13	mA

2. Pulse Test: Pulse Width < 300us, Duty Cycle < 2.0%

Electrical Characteristics (TA=25°C Unless Otherwise noted)

Characteristics	Symbol	Min	Typ	Max	Unit	
On Characteristics⁽³⁾						
DC Current Gain $V_{CE}=-10V, I_C=5.0mA$	DTC114EE DTC124EE DTC144EE DTC114YE DTC114TE DTC143TE DTC123EE DTC143EE DTC143ZE DTC124XE DTC123JE DTC115EE DTC144WE	h_{FE}	35 60 80 80 160 160 8.0 15 80 80 80 80 80	60 100 140 140 250 250 15 27 140 130 140 150 140	- - - - - - - - - - - - -	-
Collector-Emitter Saturation Voltage $I_C=10mA, I_E=0.3mA$ $I_C=10mA, I_E=5.0mA$ $I_C=10mA, I_E=1.0mA$	DTC123EE DTC114TE / DTC143TE DTC143ZE / DTC124XE DTC143EE	$V_{CE(sat)}$	-	-	0.25	-
Output Voltage(on) $V_{CC}=5.0V, V_B=2.5V R_L=1.0K\Omega$ $V_{CC}=5.0V, V_B=3.5V R_L=1.0K\Omega$ $V_{CC}=5.0V, V_B=5.5V R_L=1.0K\Omega$ $V_{CC}=5.0V, V_B=4.0V R_L=1.0K\Omega$	DTC114EE DTC124EE DTC144EE DTC114YE DTC114TE DTC143TE DTC123EE DTC143EE DTC143ZE DTC124XE DTC123JE DTC115EE DTC144WE	V_{OL}	-	-	0.2	V

3. Pulse Test: Pulse Width < 300us, Duty Cycle < 2.0%

Electrical Characteristics (TA=25°C Unless Otherwise noted)

Characteristics	Symbol	Min	Typ	Max	Unit
On Characteristics⁽⁴⁾					
Output Voltage(off) V _{CC} =5.0V, V _B =0.5V R _L =1.0KΩ V _{CC} =5.0V, V _B =0.25V R _L =1.0KΩ	DTC114TE DTC143TE DTC143ZE V _{OH}	4.9	-	-	V
Input Resistor	DTC114EE DTC124EE DTC144EE DTC114YE DTC114TE DTC143TE DTC123EE DTC143EE DTC143ZE DTC124XE DTC123JE DTC115EE DTC144WE R1	7.0 15.4 32.9 7.0 7.0 3.3 1.5 3.3 3.3 15.4 15.4 70 32.9	10 22 47 10 10 4.7 2.2 4.7 4.7 22 2.2 100 47	13 28.6 61.1 13 13 6.1 2.9 6.1 6.1 28.6 2.86 130 61.1	kΩ
Resistor Ratio	DTC114EE / DTC124EE DTC144EE / DTC115EE DTC114YE DTC114TE / DTC143TE DTC123EE / DTC143EE DTC143ZE DTC124XE DTC123JE DTC144WE R1/R2	0.8 0.17 - 0.8 0.055 0.38 0.038 1.7	1.0 0.21 - 1.0 0.1 0.47 0.047 2.1	1.2 0.25 - 1.2 0.185 0.56 0.056 2.6	-

4. PulseTest: Pulse Width < 300us, Duty Cycle < 2.0%

DTC114EE Series

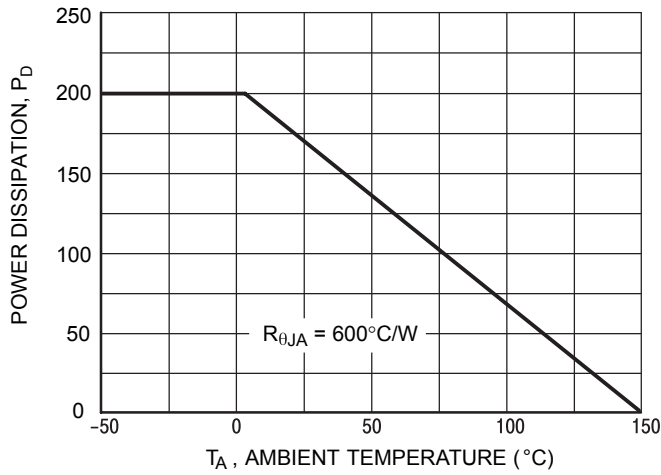

Figure 1. Derating Curve

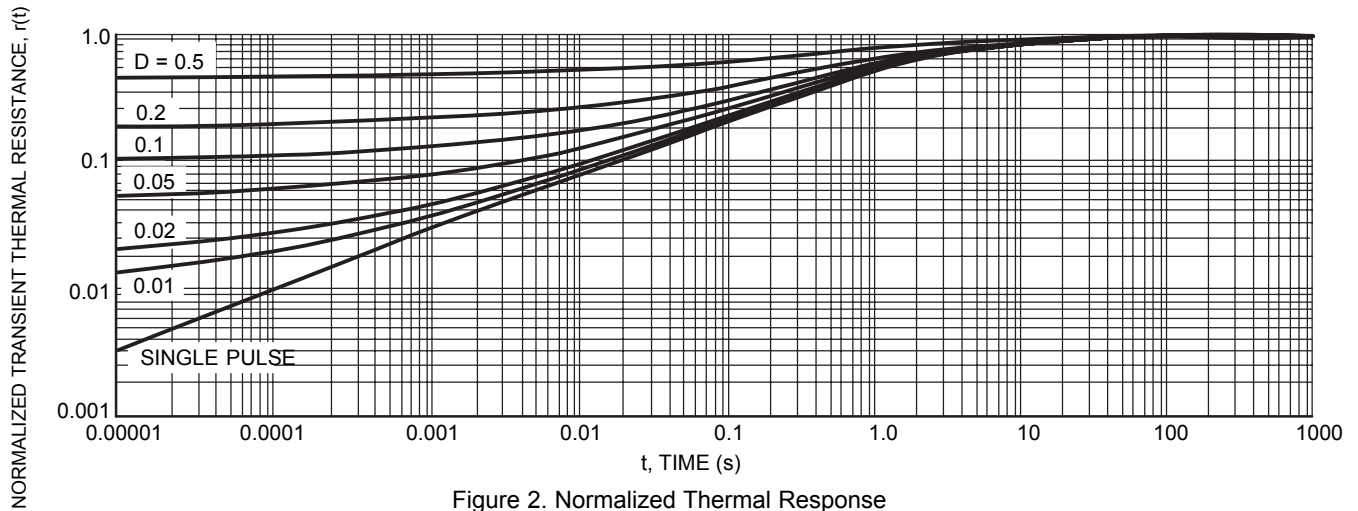

Figure 2. Normalized Thermal Response

TYPICAL ELECTRICAL CHARACTERISTICS – DTC114EE

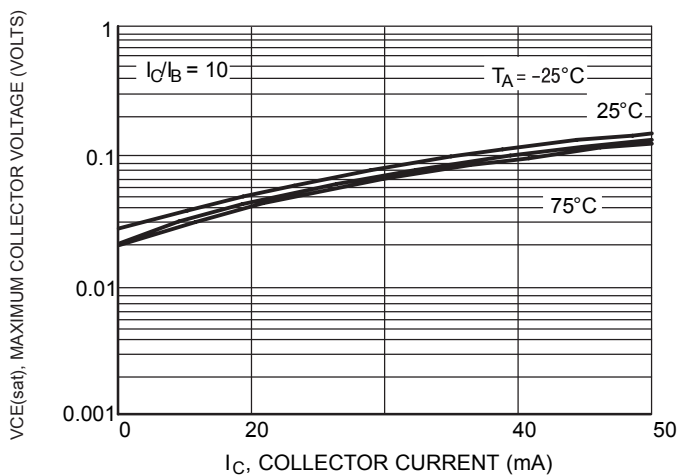

Figure 3. $V_{CE(sat)}$ versus I_C

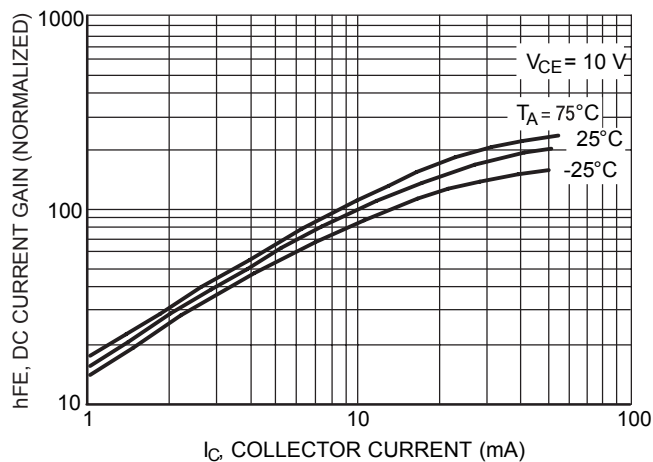

Figure 4. DC Current Gain

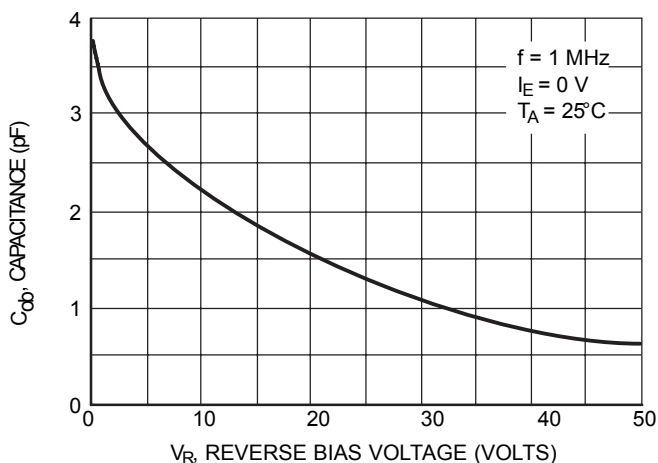

Figure 5. Output Capacitance

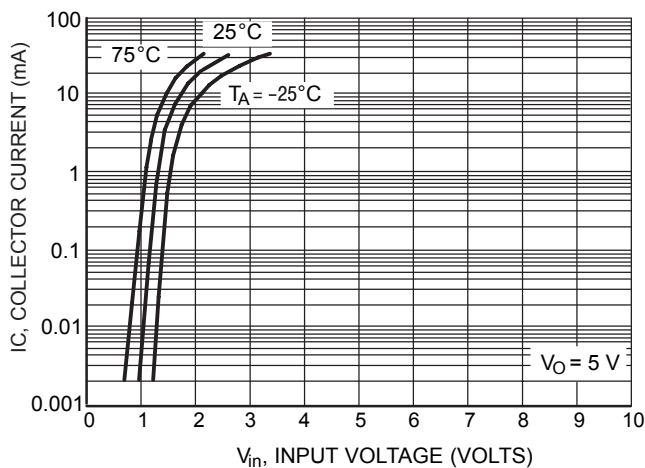

Figure 6. Output Current versus Input Voltage

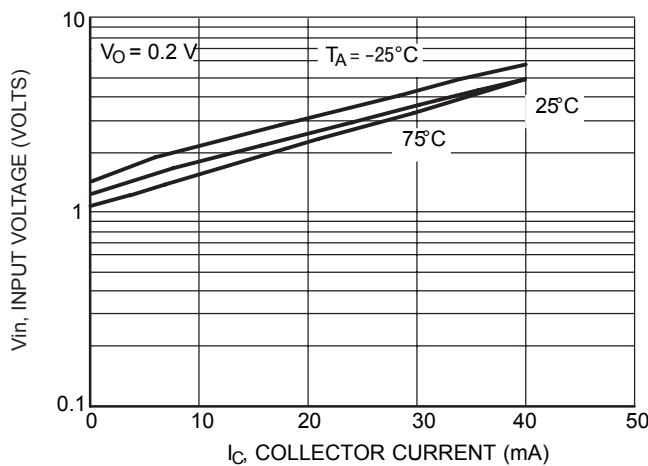

Figure 7. Input Voltage versus Output Current

TYPICAL ELECTRICAL CHARACTERISTICS – DTC123EE

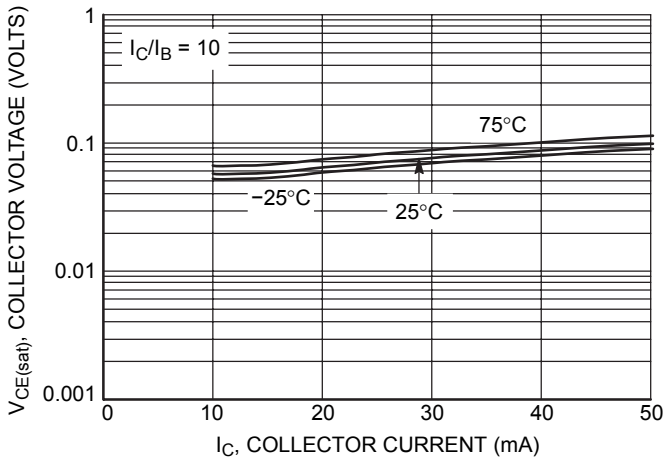

Figure 8. $V_{CE(sat)}$ versus I_C

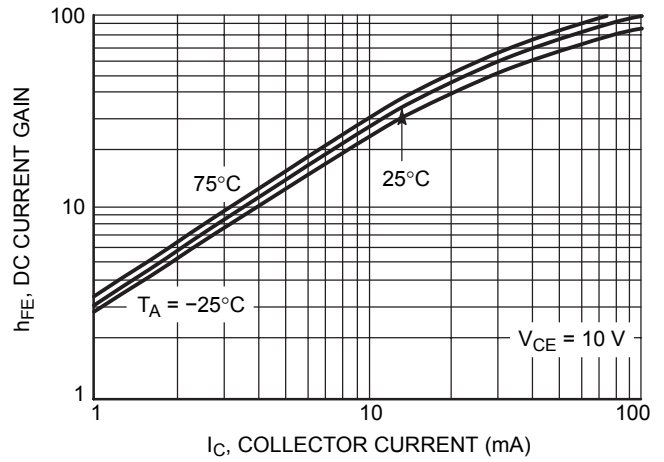

Figure 9. DC Current Gain

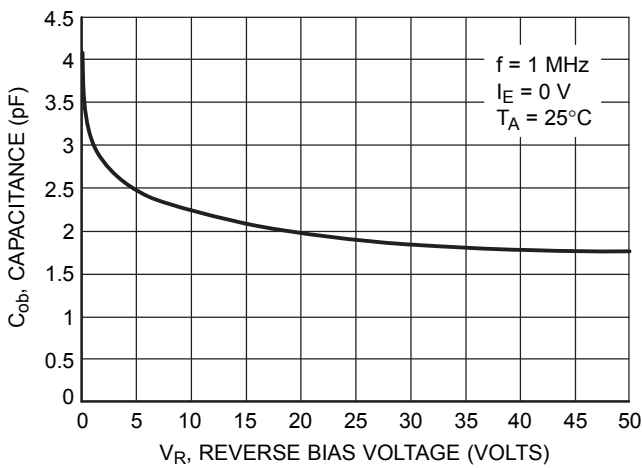

Figure 10. Output Capacitance

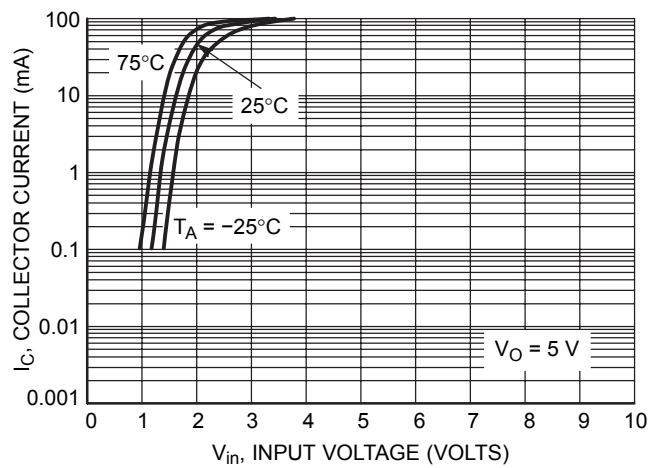

Figure 11. Output Current versus Input Voltage

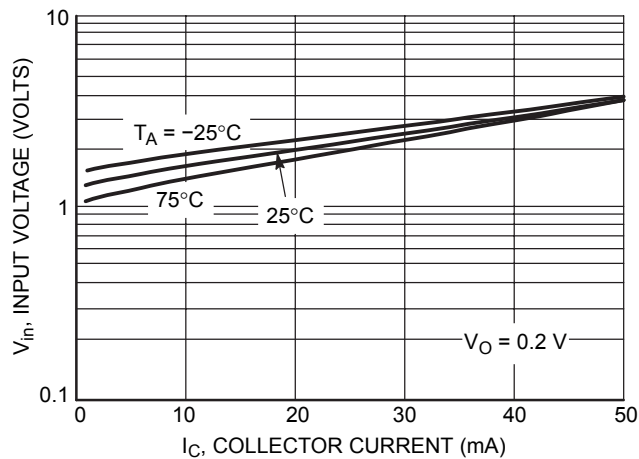

Figure 12. Input Voltage versus Output Current

TYPICAL ELECTRICAL CHARACTERISTICS – DTC124EE

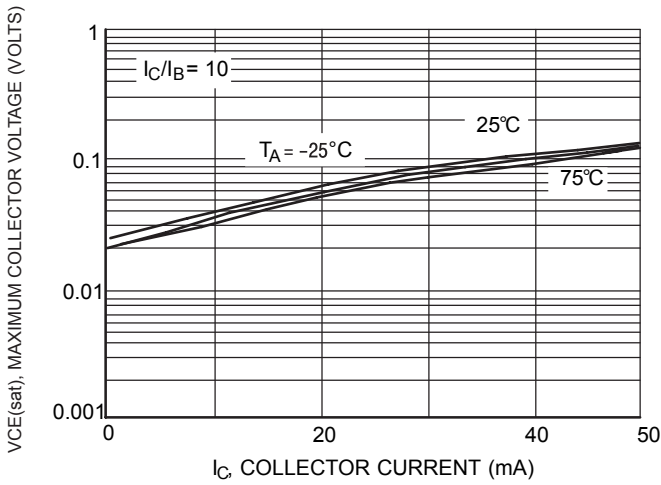

Figure 13. $V_{CE(sat)}$ versus I_C

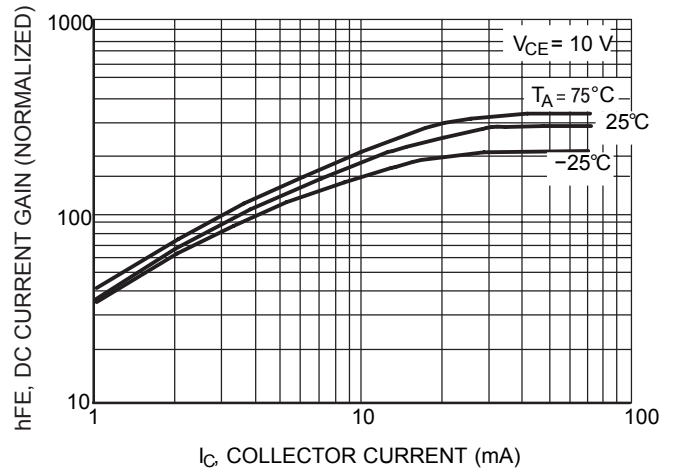

Figure 14. DC Current Gain

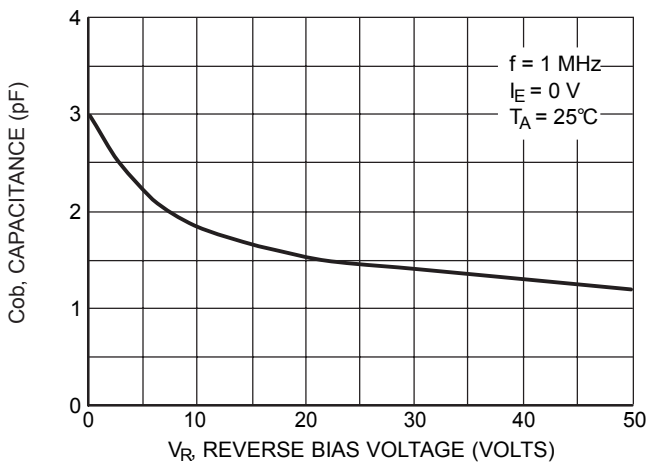

Figure 15. Output Capacitance

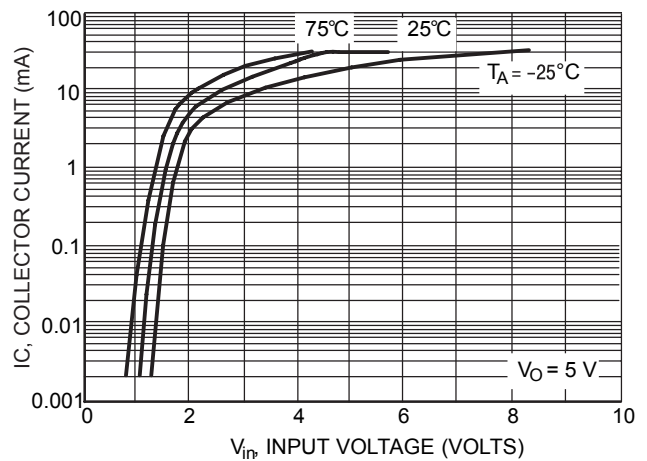

Figure 16. Output Current versus Input Voltage

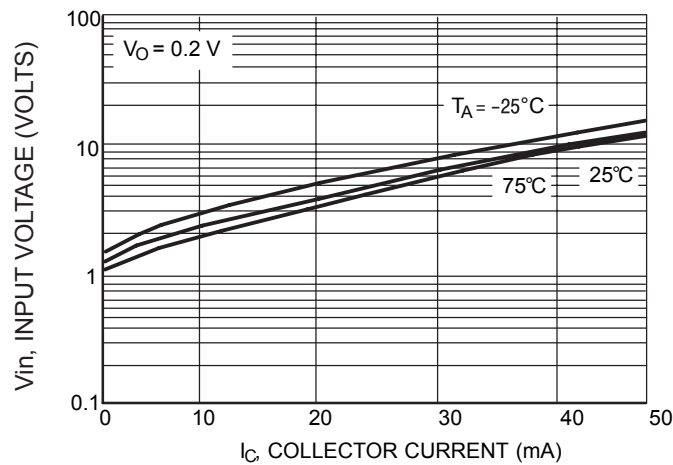

Figure 17. Input Voltage versus Output Current

TYPICAL ELECTRICAL CHARACTERISTICS - DTC114EE

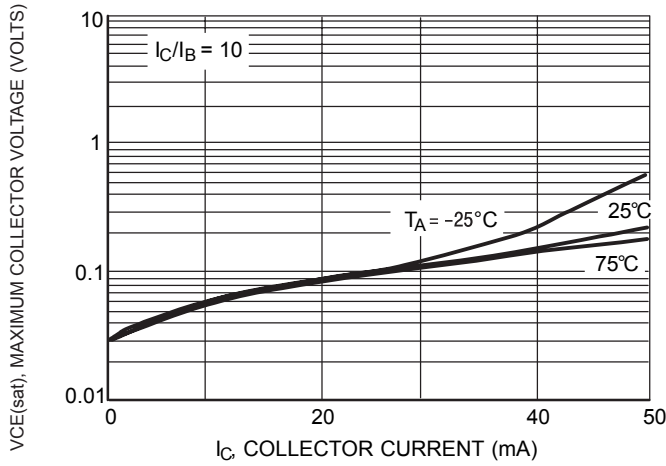

Figure 18. $V_{CE(sat)}$ versus I_C

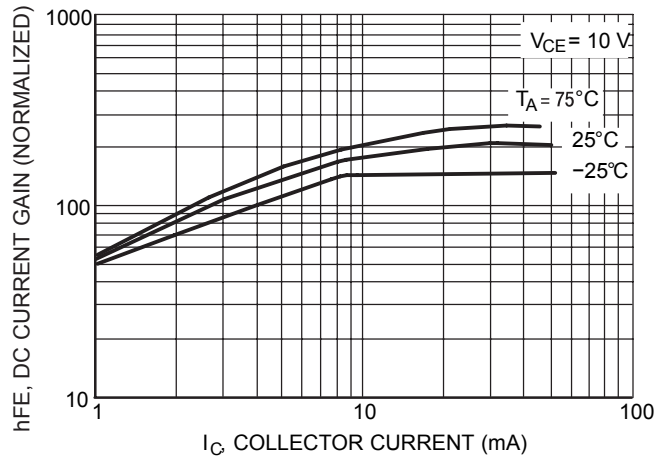

Figure 19. DC Current Gain

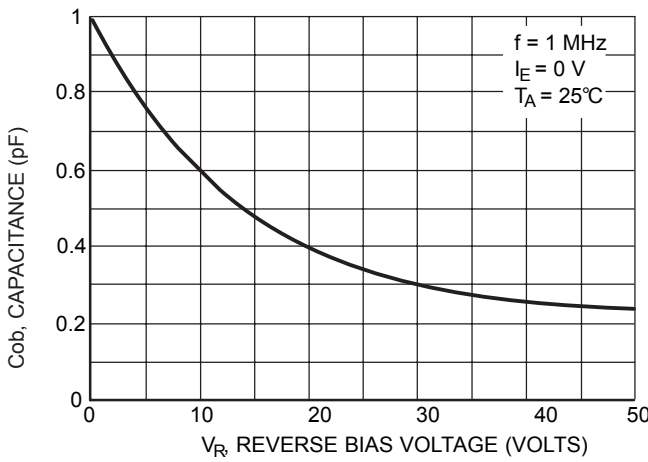

Figure 20. Output Capacitance

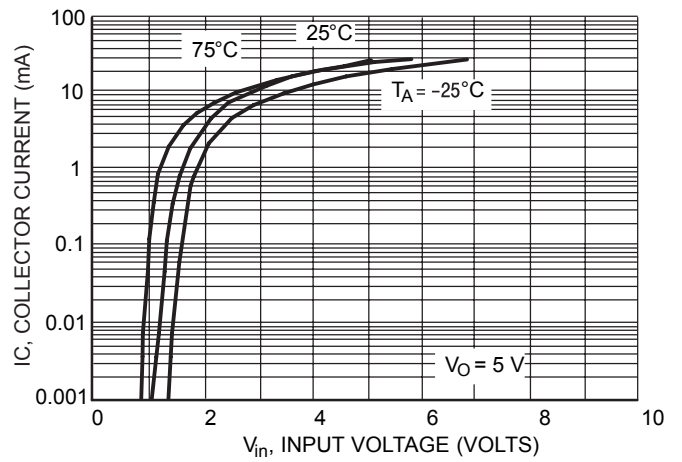

Figure 21. Output Current versus Input Voltage

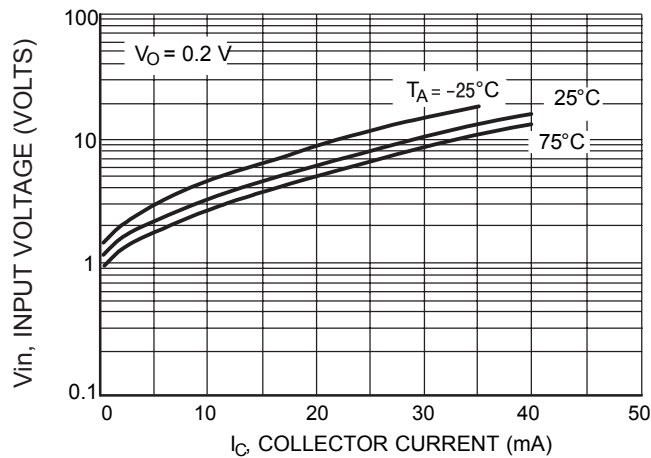

Figure 22. Input Voltage versus Output Current

TYPICAL ELECTRICAL CHARACTERISTICS – DTC114YE

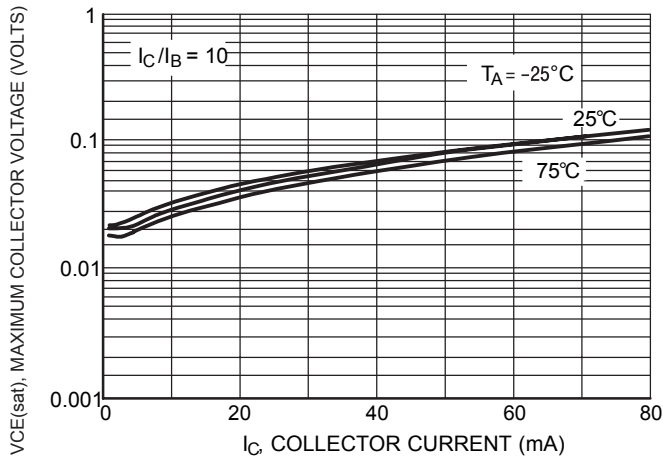

Figure 23. $V_{CE(sat)}$ versus I_C

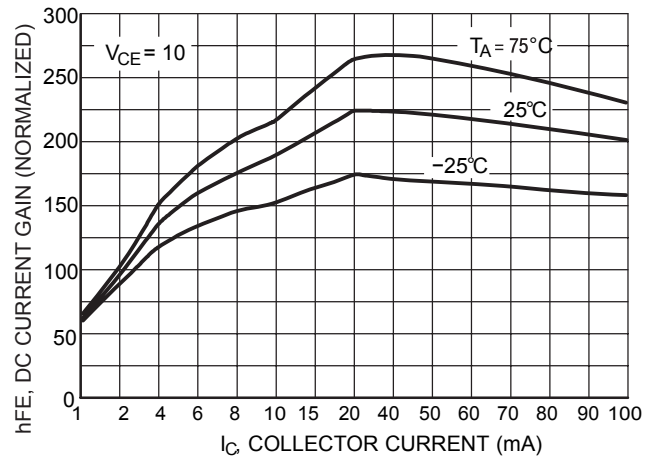

Figure 24. DC Current Gain

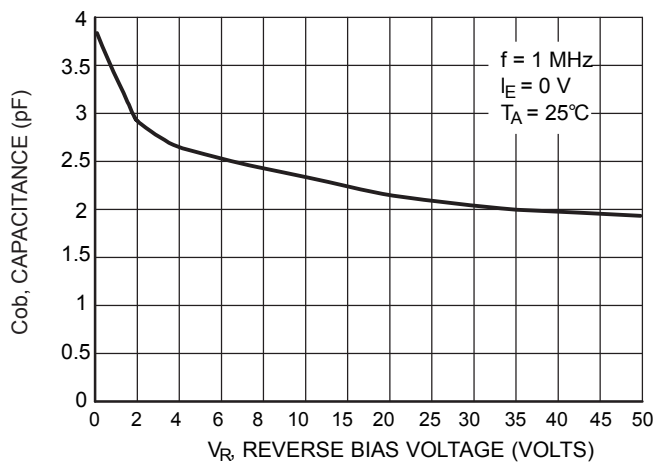

Figure 25. Output Capacitance

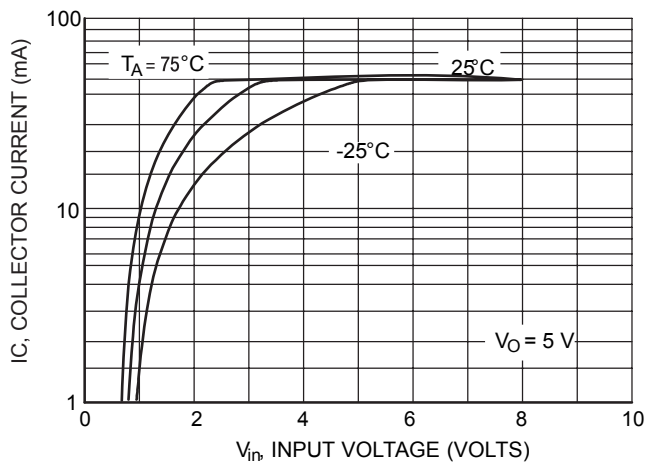

Figure 26. Output Current versus Input Voltage

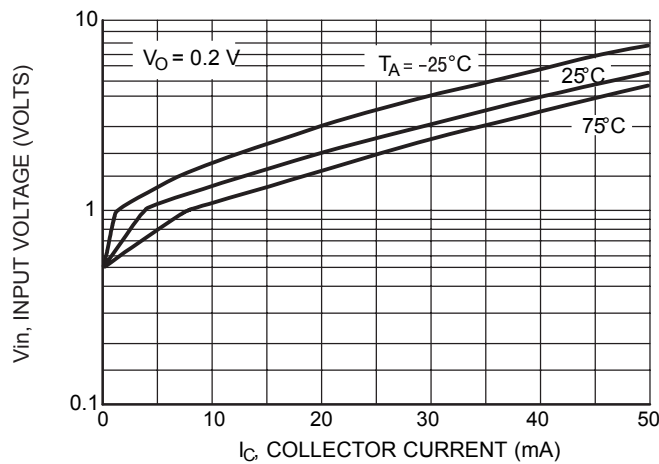

Figure 27. Input Voltage versus Output Current

TYPICAL ELECTRICAL CHARACTERISTICS — DTA115EE1

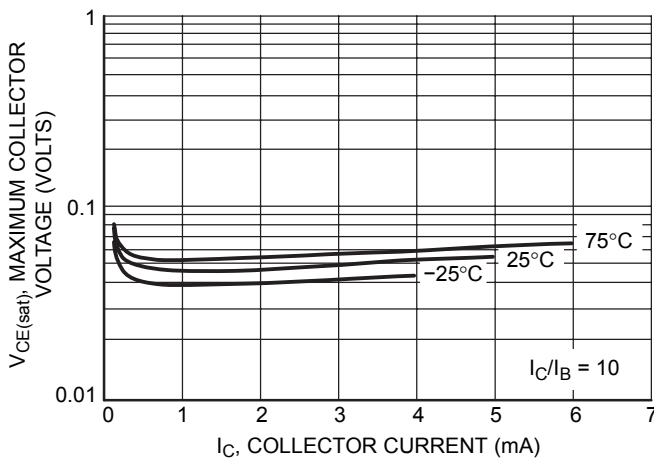

Figure 29. Maximum Collector Voltage versus Collector Current

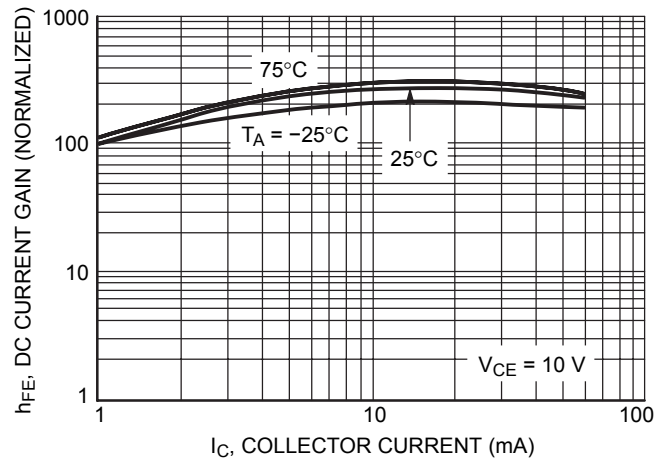

Figure 30. DC Current Gain

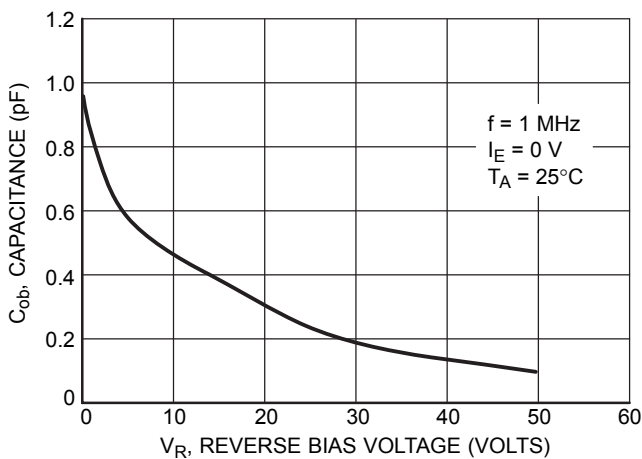

Figure 31. Output Capacitance

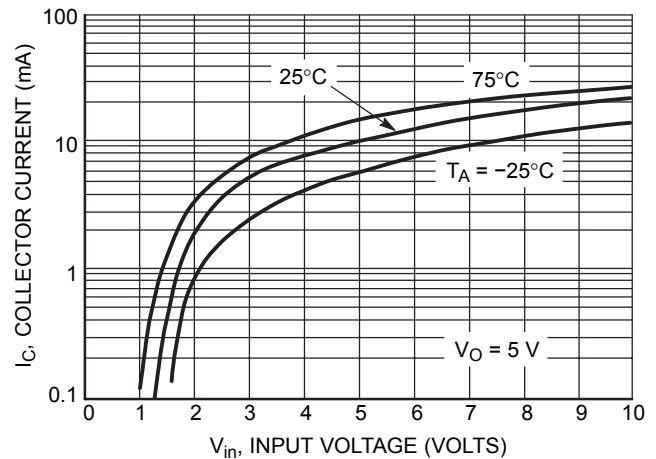

Figure 32. Output Current versus Input Voltage

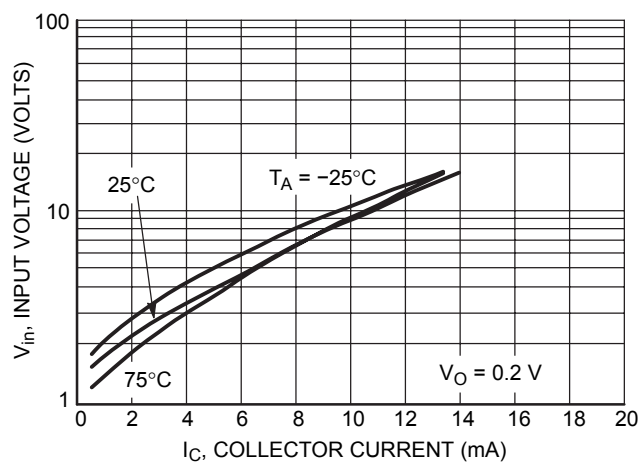

Figure 33. Input Voltage versus Output Current

TYPICAL APPLICATIONS FOR NPN BRTs

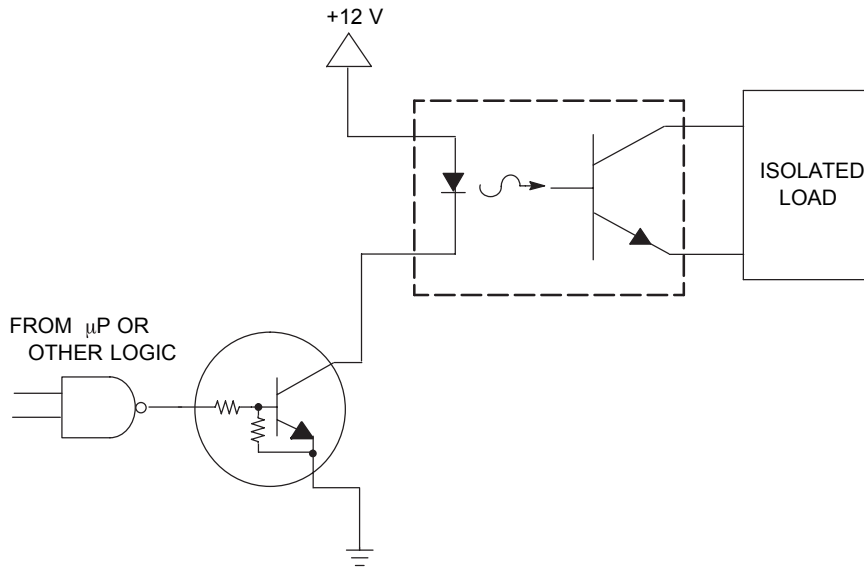

Figure 28. Level Shifter: Connects 12 or 24 Volt Circuits to Logic

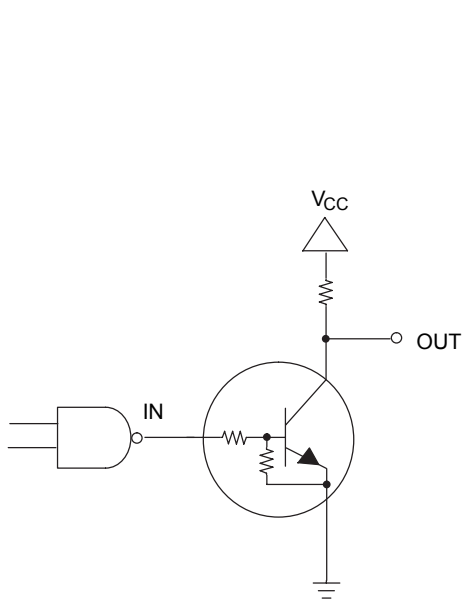

Figure 29. Open Collector Inverter: Inverts the Input Signal

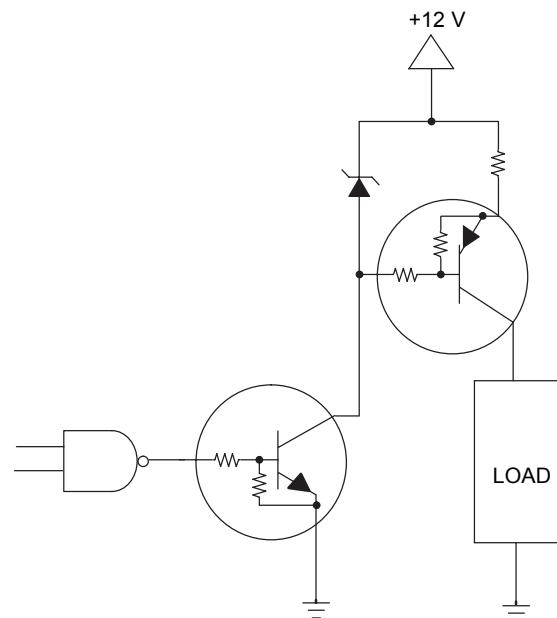
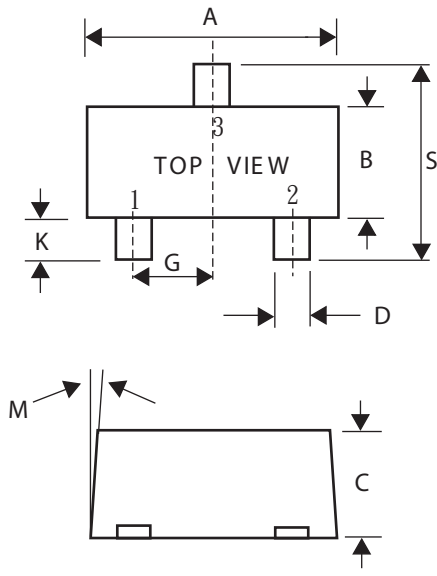

Figure 30. Inexpensive, Unregulated Current Source

SC-89 Outline Demensions

Unit:mm



SC-89			
Dim	Min	Nom	Max
A	1.50	1.60	1.70
B	0.75	0.85	0.95
C	0.60	0.70	0.80
D	0.23	0.28	0.33
G	0.50BSC		
J	0.10	0.15	0.20
K	0.30	0.40	0.50
M	---	---	10°
N	---	---	10°
S	1.50	1.60	1.70