

OUTLINE

The CMOS LSI of TC6133AF was developed to drive the TCD5241BD, TCD5251BD, TCD5240D and TCD5250D. The TC6133AF can be combined with a vertical clock driver to constitute the CCD area image sensor driving circuit.

FEATURES

- Generation of all timing pulses required to drive TCD5241BD, TCD5251BD, TCD5240D, and TCD5250D.
- Correspondence with electronic shutter from 1/50 s, 1/60 s to 1/10000 s.
- Generation of sampling pulses for the CDS signal processing.
- Generation of controlling pulse for the electronic shutter iris.

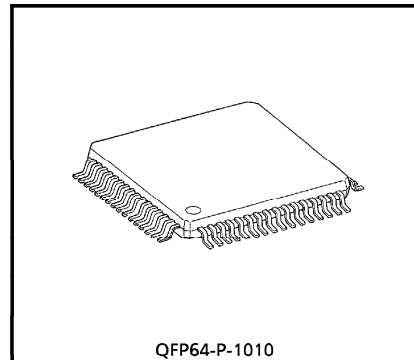

Weight : 0.33g (Typ.)

MAXIMUM RATINGS ($V_{SS} = 0V$)

CHARACTERISTIC	SYMBOL	RATING	UNIT
Supply Voltage	V_{DD}	-0.3~7.0	V
Input Voltage	V_{IN}	-0.3~ $V_{DD} + 0.3$	V
Input Current	I_{IN}	± 10	mA
Storage Temperature	T_{stg}	-40~125	$^{\circ}C$

RECOMMENDED OPERATING CONDITIONS ($V_{SS} = 0V$)

CHARACTERISTIC	SYMBOL	RATING	UNIT
Supply Voltage	V_{DD}	4.50~5.50	V
Operating Temperature	T_{opr}	-20~70	$^{\circ}C$

© The information contained herein is presented only as a guide for the applications of our products. No responsibility is assumed by TOSHIBA CORPORATION for any infringements of intellectual property or other rights of the third parties which may result from its use. No license is granted by implication or otherwise under any intellectual property or other rights of TOSHIBA CORPORATION or others.

② These TOSHIBA products are intended for use in general commercial applications (office equipment, communication equipment, measuring equipment, domestic appliances, etc.), please make sure that you consult with us before you use these TOSHIBA products in equipment which requires extraordinarily high quality and/or reliability, and in equipment which may involve life threatening or critical application, including but not limited to such uses as atomic energy control, airplane or spaceship instrumentation, traffic signals, medical instrumentation, combustion control, all types of safety devices, etc. TOSHIBA cannot accept and hereby disclaims liability for any damage which may occur in case the TOSHIBA products are used in such equipment or applications without prior consultation with TOSHIBA.

TC6133AF - 1

1994 - 10 - 24

TOSHIBA CORPORATION

ELECTRICAL CHARACTERISTICS ($V_{SS} = 0V$, $V_{DD} = 4.75 \sim 5.25V$, $T_a = 0 \sim 70^\circ C$)

CHARACTERISTIC		SYMBOL	TEST CONDITIONS	MIN.	TYP.	MAX.	UNIT
Input Voltage	"H" Level	V_{IH}		3.5	—	—	V
	"L" Level	V_{IL}		—	—	1.5	
Input Current	"H" Level	I_{IH}	$V_{IN} = V_{DD}$	-10	—	10	μA
			$V_{IN} = V_{DD}$, (included PULL-DOWN)	10	—	200	
	"L" Level	I_{IL}	$V_{IN} = V_{SS}$	-10	—	10	
			$V_{IN} = V_{SS}$, (included PULL-UP)	-200	—	-10	
Output Voltage	"H" Level	V_{OH}	$I_{OH} = -8mA$, H1A, H2A	2.4	—	—	V
			$I_{OH} = -4mA$ except H1A, H2A				
	"L" Level	V_{OL}	$I_{OL} = 8mA$, H1A, H2A	—	—	0.4	
			$I_{OL} = 4mA$ except H1A, H2A				
Static Consumption Current		I_{DD}	$C_L = 0pF$, $V_{DD} = 5V$, $T_a = 25^\circ C$	—	—	200	μA

PIN CONNECTION

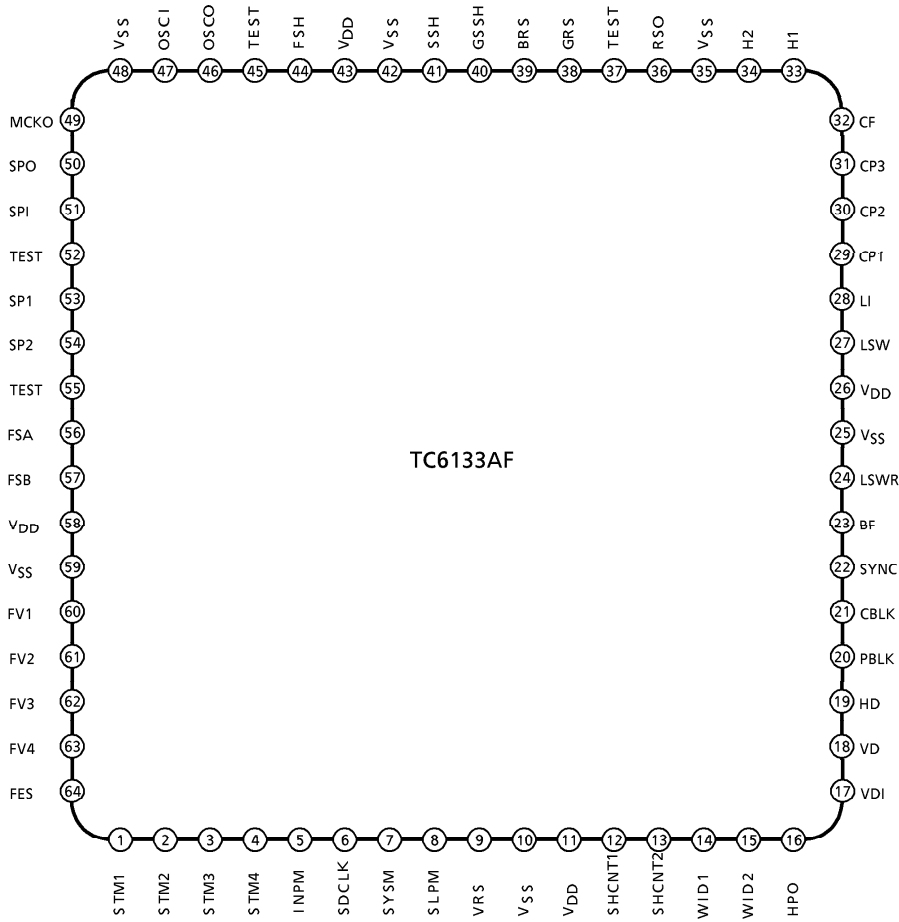





TC6133AF - 3

1994 - 10 - 24

TOSHIBA CORPORATION















PIN FUNCTION















PIN No.	SYMBOL	I/O	POLARITY	FUNCTION
1	STM1	I (PULL DOWN)	—	Shutter period setting terminal. (See the attached table for the shutter period.)
2	STM2	I (PULL DOWN)	—	
3	STM3	I (PULL DOWN)	—	
4	STM4	I (PULL DOWN)	—	
5	INPM	I (PULL DOWN)	—	Open for normal use.
6	SDCLK	I (PULL DOWN)	—	Open for normal use.
7	SYSM	I (PULL DOWN)	—	Terminal for switching PAL or NTSC mode. - NTSC mode in L level - PAL mode in H level
8	SLPM	I (PULL DOWN)	—	Terminal for switching change mode of the electronic shutter. - Step mode in L level - Slope mode in H level
9	VRS	I (PULL UP)	—	Vertical reset input is normally opened.
10	V _{SS}	—	—	GND
11	V _{DD}	—	—	Connected to power supply 5.0V ± 0.5V.
12	SHCNT1	I (PULL DOWN)	—	Input terminal for controlling electronic shutter iris.
13	SHCNT2	I (PULL DOWN)	—	
14	WID1	O		Window pulse for sampling controlling iris signal. H level indicates 100% of horizontal period and 80% of vertical period within an effective scanning.
15	WID2	O		
16	HPO	O		Horizontal transfer control pulse. This pulse is output within horizontal flyback time to indicate that horizontal CCD transfer period has stopped.
17	VDI	I (PULL DOWN)	—	Input terminal for controlling pulse for shutter data. This terminal is normally connected to VD terminal (18 pin).
18	VD	O		Vertical drive pulse output.
19	HD	O		Horizontal drive pulse output.

TC6133AF - 4

1994 - 10 - 24

TOSHIBA CORPORATION

PIN No.	SYMBOL	I/O	POLARITY	FUNCTION
20	PBLK	O		Pre-blanking pulse output. H level indicates the erase period.
21	CBLK	O		Composite blanking pulse output.
22	SYNC	O		Composite synchronization pulse output.
23	BF	O		Burst frag pulse output.
24	LSWR	I (PULL UP)	—	Reset input LSW.
25	V _{SS}	—	—	GND
26	V _{DD}	—	—	Connected to power supply 5.0±0.5V.
27	LSW	O		Line switching output. This pulse is used for switching sub carrier of PAL system.
28	LI	O		Line identification pulse output for color identifying of CCD image sensor with line sequential color filter. This pulse alternately goes high and low every horizontal cycle, and is reset on the frame cycle. This pulse indicates H level for 2B-G line and L level for 2R-G line.
29	CP1	O		Clamp pulse output for clamping the OB portion of CCD signal output. This signal halts when the OB signal is not output within the vertical flyback time.
30	CP2	O		Clamp pulse output for signal processing. This signal is also output in the vertical flyback time.
31	CP3	O		
32	CF	O		Color field pulse output. H level indicates 1st field every 4 fields in NTSC system and every 8 fields in PAL system.
33	H1	O		Horizontal CCD drive pulse to be connected to the H1 or H2 gate of the CCD image sensor.
34	H2	O		
35	V _{SS}	—	—	GND
36	RSO	O		CCD reset gate drive pulse to be connected to RS terminal of CCD image sensor through a capacitor.
37	TEST	I (PULL DOWN)	—	The test terminal is normally opened.
38	GRS	I	—	Input and output terminal for adjusting RSO and SSH phase. The BRS output is delayed with capacitor and resistor.
39	BRS	O		
40	GSSH	I	—	

PIN No.	SYMBOL	I/O	POLARITY	FUNCTION
41	SSH	O		Signal sampling pulse output.
42	V _{SS}	—	—	GND
43	V _{DD}	—	—	Connected to power supply 5.0V ± 0.5V.
44	FSH	O		Feed through sampling pulse output.
45	TEST	I (PULL DOWN)	—	The test terminal is normally opened.
46	OSCO	O		Terminal for crystal oscillator. (2 fck) NTSC 1212 fH = 19.069930MHz PAL 1236 fH = 19.312500MHz
47	OSCI	I	—	
48	V _{SS}	—	—	GND
49	MCKO	O		Clock pulse output. (fck)
50	SPO	O		Input and output terminal for SPO and SPI phase adjusting. The SPO output is delayed with a capacitor and resistor connected to the SPI input.
51	SPI	I	—	
52	TEST	I (PULL DOWN)	—	The test terminal is normally opened.
53	SP1	O		Sampling pulse for color separation. The frequency is fck / 2 and H level is output for duty ratio 25% (about 51 ns). SP1 and SP2 always shift 180 degrees.
54	SP2	O		
55	TEST	I (PULL DOWN)	—	The test terminal is normally opened.
56	FSA	O		Field shift drive pulse φV1 and φV3 connected to the inversion type vertical clock driver.
57	FSB	O		
58	V _{DD}	—	—	Connected to power supply 5.0V ± 0.5V.
59	V _{SS}	—	—	GND
60	FV1	O		Vertical CCD drive pulse φV1, φV2, φV3 and φV4 connected to the inversion type vertical clock driver.
61	FV2	O		
62	FV3	O		
63	FV4	O		
64	FES	O		Electronic shutter pulse connected the inversion type driver.

SETTING FOR ELECTRONIC SHUTTER SPEED

The shutter speed depends on inputs on STM1-4

STM1	STM2	STM3	STM4	Shutter speed (s)
L	L	L	L	Normal
H	L	L	L	1 / 100 (1 / 60)*
L	H	L	L	1 / 120
H	H	L	L	1 / 250
L	L	H	L	1 / 500
H	L	H	L	1 / 1000
L	H	H	L	1 / 2000
H	H	H	L	1 / 4000
L	L	L	H	1 / 8000
H	L	L	H	1 / 10000
H	H	H	H	Electronic shutter iris

* 1 / 60 s in PAL system.

- Electronic shutter change mode.

SLPM		
L	Step change	When the electronic shutter speed is set, the shutter speed is changed the set time in the next field.
H	Slope change	When the electronic shutter speed is set, the shutter speed is changed gradually. The changing slope depends on the shutter speed.

• **ELECTRONICS SHUTTER IRIS**

If SLPM = H and STM1-4 = H, electronic shutter iris mode is available. Inputs on SHCNT1 and SHCNT2 control shutter speed.

SHCNT1	SHCNT2	
H	L	Change at high speed
H	H	Keep the shutter speed
L	H	Change at low speed

TYPICAL CIRCUIT (Electronic shutter iris)

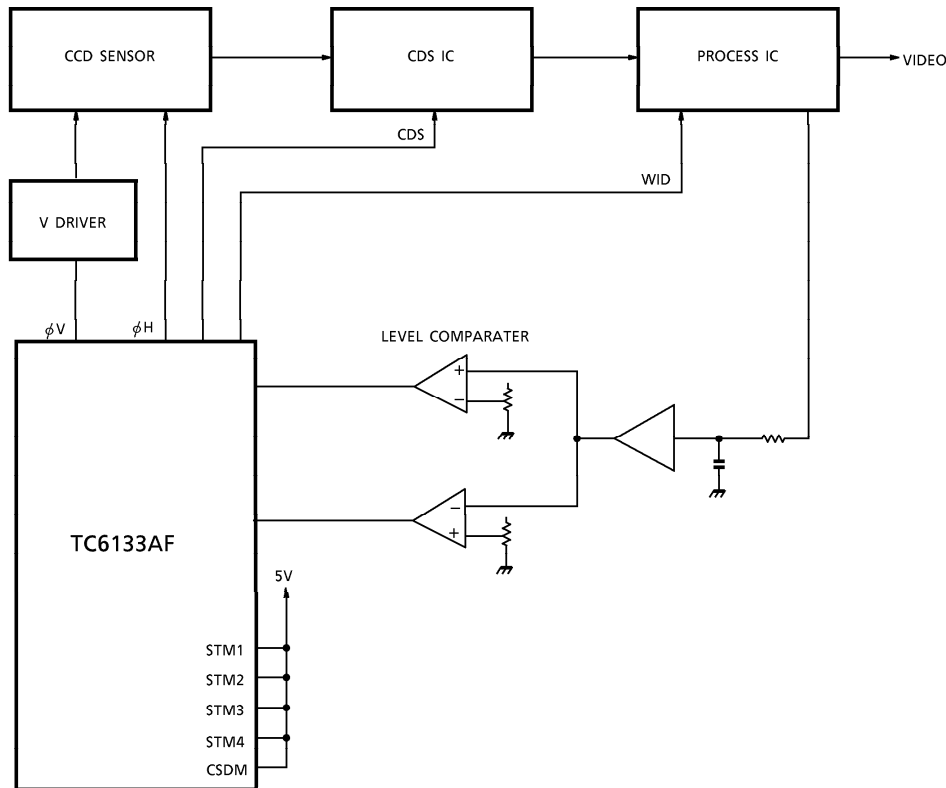

TC6133AF - 8

1994 - 10 - 24

TOSHIBA CORPORATION

PULSE PHASE ADJUSTING

- SSH, RS

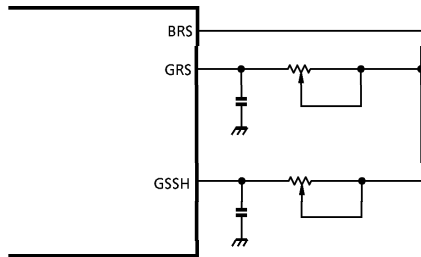

- SP1, SP2

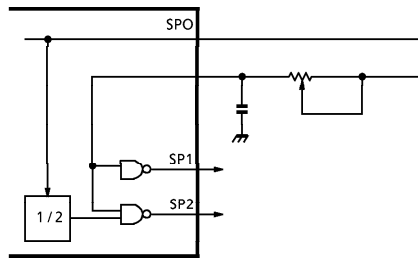

OUTLINE DRAWING
QFP64-P-1010

Unit : mm

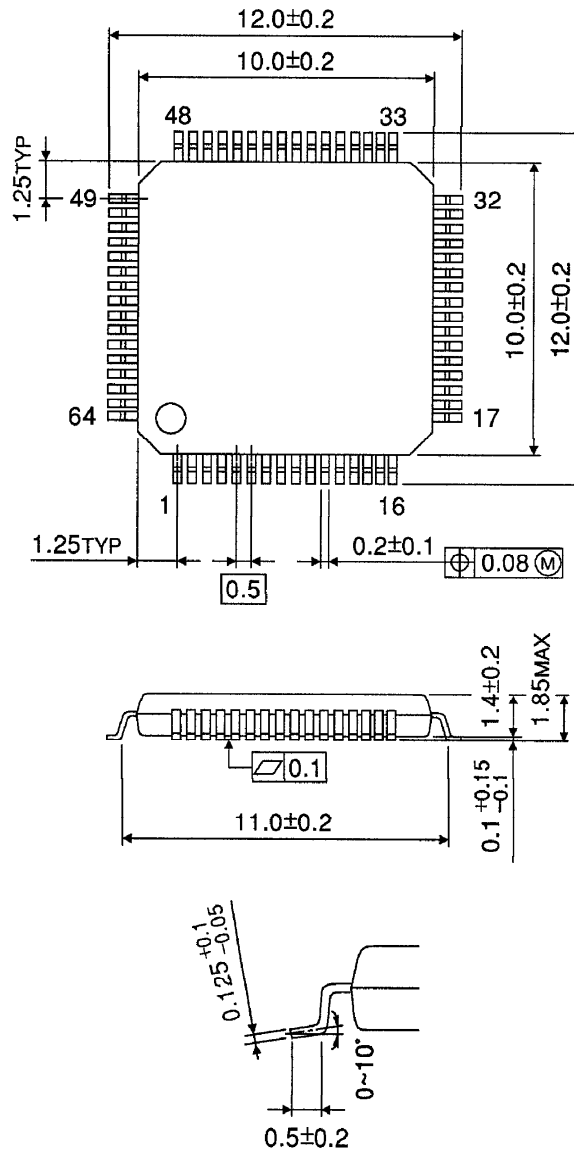

Weight : 0.33g (Typ.)

TC6133AF - 10*

1994 - 10 - 24

TOSHIBA CORPORATION