

**Rectifier diodes  
ultrafast, rugged**

**BYV79EB series**

**FEATURES**

- Low forward volt drop
- Fast switching
- Soft recovery characteristic
- Reverse surge capability
- High thermal cycling performance
- Low thermal resistance

**SYMBOL**

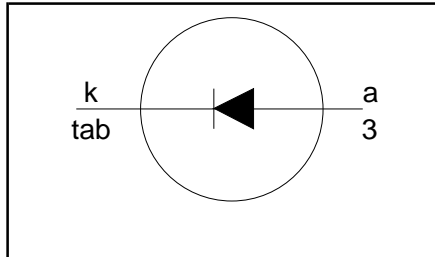

**QUICK REFERENCE DATA**

$V_R = 150\text{ V} / 200\text{ V}$
$V_F \leq 0.9\text{ V}$
$I_{F(AV)} = 14\text{ A}$
$I_{RRM} = 0.2\text{ A}$
$t_{tr} \leq 30\text{ ns}$

**GENERAL DESCRIPTION**

Ultra-fast, epitaxial rectifier diodes intended for use as output rectifiers in high frequency switched mode power supplies.

The BYV79EB series is supplied in the surface mounting SOT404 package.

**PINNING**

PIN	DESCRIPTION
1	no connection
2	cathode <sup>1</sup>
3	anode
tab	cathode

**SOT404**

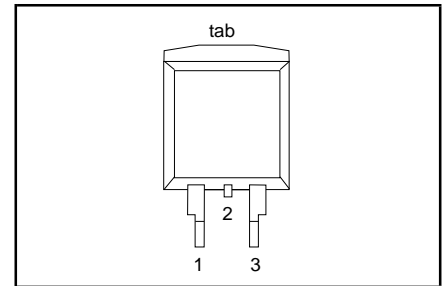

**LIMITING VALUES**

Limiting values in accordance with the Absolute Maximum System (IEC 134).

SYMBOL	PARAMETER	CONDITIONS	MIN.	MAX.		UNIT
				BYV79EB		
$V_{RRM}$	Peak repetitive reverse voltage	$T_{mb} \leq 145^\circ\text{C}$	-	-150	-200	V
$V_{RWM}$	Crest working reverse voltage		-	150	200	V
$V_R$	Continuous reverse voltage		-	150	200	V
$I_{F(AV)}$	Average rectified forward current <sup>2</sup>	square wave $\delta = 0.5; T_{mb} \leq 120^\circ\text{C}$	-	14		A
$I_{FRM}$	Repetitive peak forward current per diode	$t = 25\ \mu\text{s}; \delta = 0.5;$ $T_{mb} \leq 120^\circ\text{C}$	-	28		A
$I_{FSM}$	Non-repetitive peak forward current	$t = 10\text{ ms}$	-	150		A
		$t = 8.3\text{ ms}$ sinusoidal; with reapplied $V_{RRM(max)}$	-	160		A
$I_{RRM}$	Repetitive peak reverse current	$t_p = 2\ \mu\text{s}; \delta = 0.001$	-	0.2		A
$I_{RSM}$	Non-repetitive peak reverse current	$t_p = 100\ \mu\text{s}$	-	0.2		A
$T_{stg}$	Storage temperature		-40	150		$^\circ\text{C}$
$T_j$	Operating junction temperature		-	150		$^\circ\text{C}$

1. It is not possible to make connection to pin 2 of the SOT404 package

2. Neglecting switching and reverse current losses.

**ESD LIMITING VALUE**

SYMBOL	PARAMETER	CONDITIONS	MIN.	MAX.	UNIT
$V_C$	Electrostatic discharge capacitor voltage	Human body model; $C = 250\text{ pF}; R = 1.5\text{ k}\Omega$	-	8	kV

---

 Rectifier diodes  
 ultrafast, rugged
 

---

## BYV79EB series

**THERMAL RESISTANCES**

SYMBOL	PARAMETER	CONDITIONS	MIN.	TYP.	MAX.	UNIT
$R_{th\ j-mb}$	Thermal resistance junction to mounting base		-	-	2	K/W
$R_{th\ j-a}$	Thermal resistance junction to ambient	minimum footprint, FR4 board	-	50	-	K/W

**ELECTRICAL CHARACTERISTICS** $T_j = 25\text{ °C}$  unless otherwise stated

SYMBOL	PARAMETER	CONDITIONS	MIN.	TYP.	MAX.	UNIT
$V_F$	Forward voltage	$I_F = 14\text{ A}; T_j = 150\text{ °C}$	-	0.83	0.90	V
		$I_F = 14\text{ A}$	-	0.95	1.05	V
		$I_F = 50\text{ A}$	-	1.2	1.4	V
$I_R$	Reverse current	$V_R = V_{RRM}; T_j = 100\text{ °C}$	-	0.5	1.3	mA
		$V_R = V_{RRM}$	-	5	50	$\mu\text{A}$
$Q_s$	Reverse recovery charge	$I_F = 2\text{ A}; V_R \geq 30\text{ V}; -di_F/dt = 20\text{ A}/\mu\text{s}$	-	6	15	nC
$t_{rr1}$	Reverse recovery time	$I_F = 1\text{ A}; V_R \geq 30\text{ V}; -di_F/dt = 100\text{ A}/\mu\text{s}$	-	20	30	ns
$t_{rr2}$	Reverse recovery time	$I_F = 0.5\text{ A to } I_R = 1\text{ A}; I_{rec} = 0.25\text{ A}$	-	13	22	ns
$V_{fr}$	Forward recovery voltage	$I_F = 1\text{ A}; di_F/dt = 10\text{ A}/\mu\text{s}$	-	1	-	V

Rectifier diodes  
ultrafast, rugged

BYV79EB series

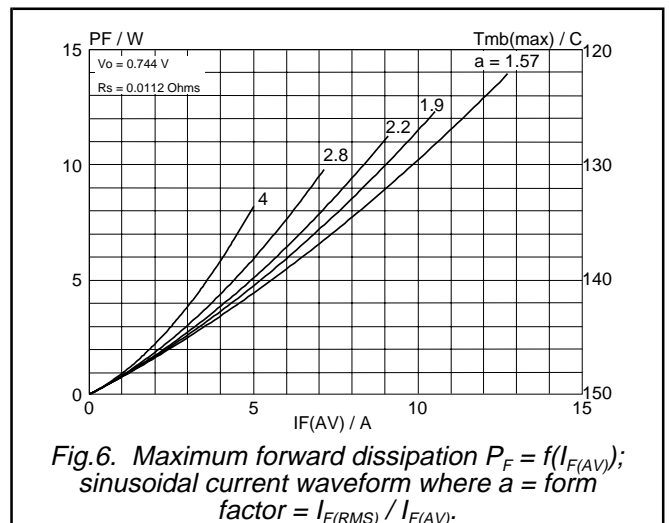
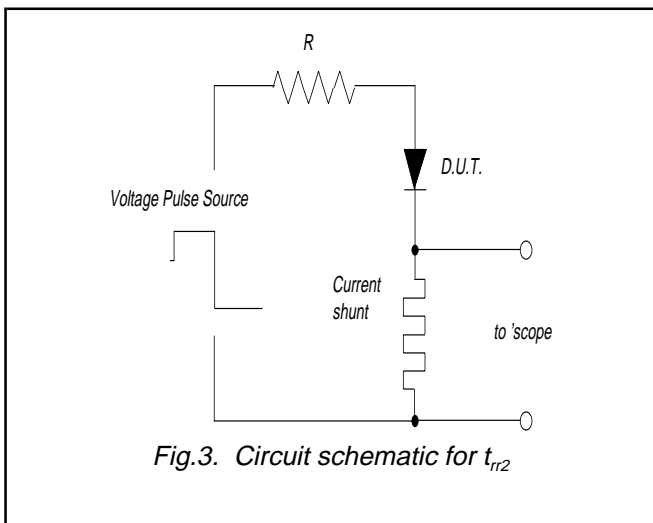
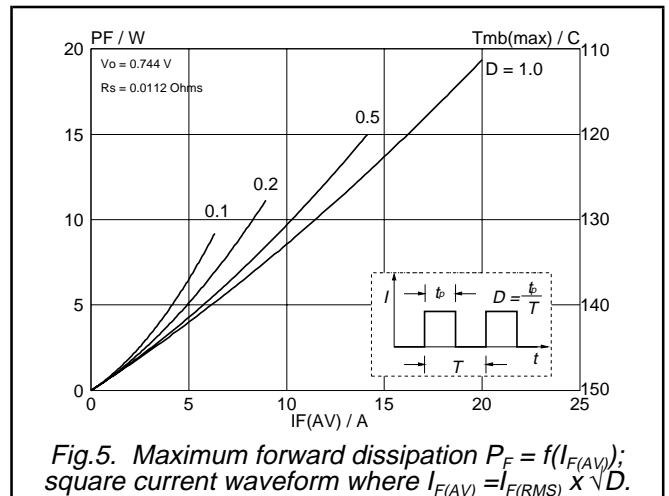
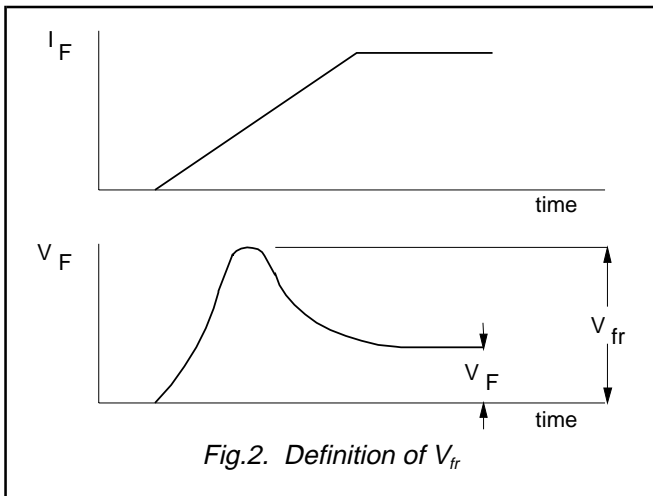
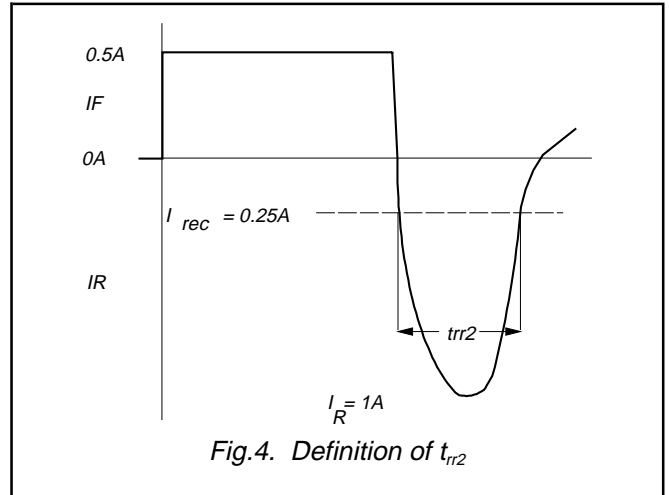
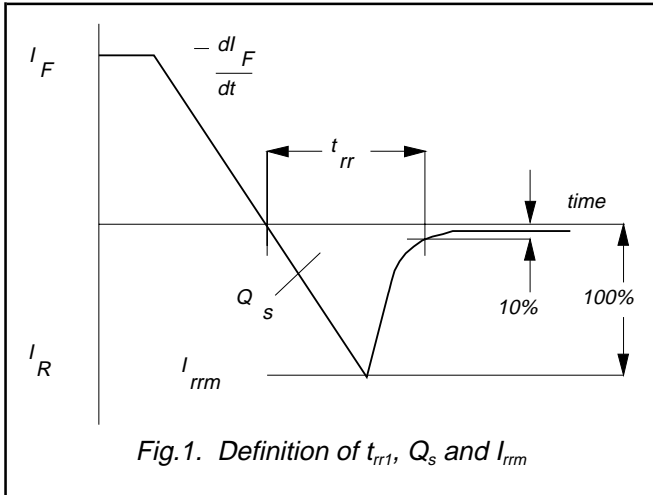

Rectifier diodes  
ultrafast, rugged

BYV79EB series

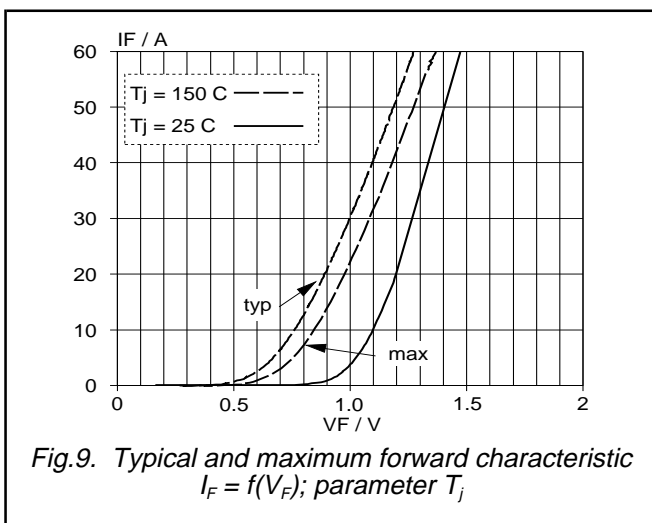
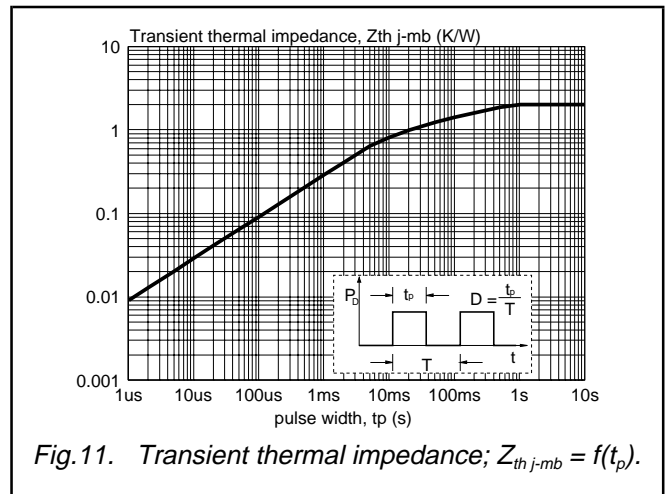
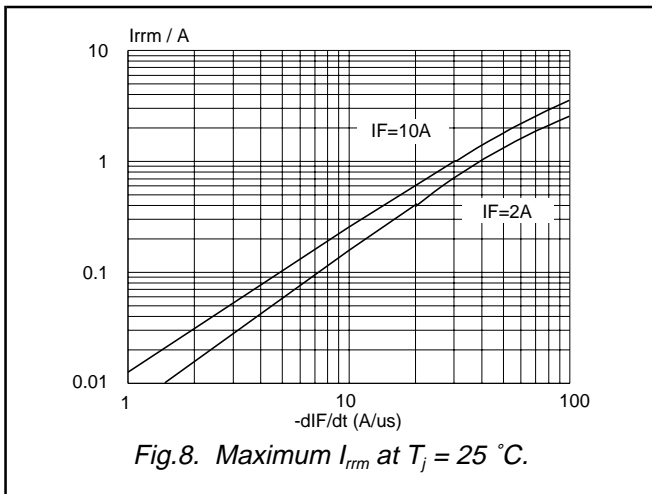
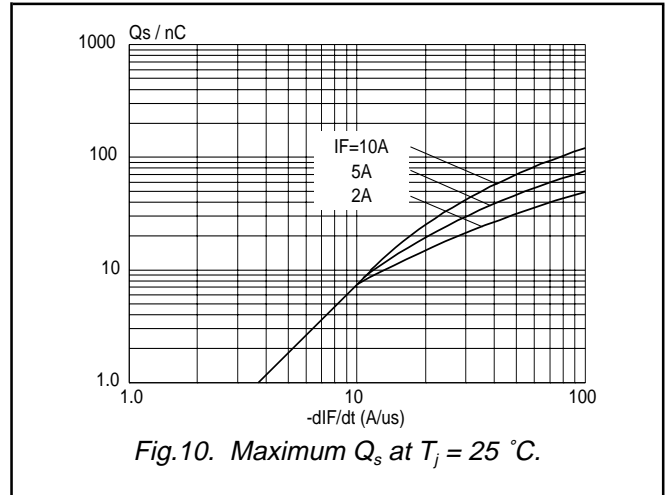
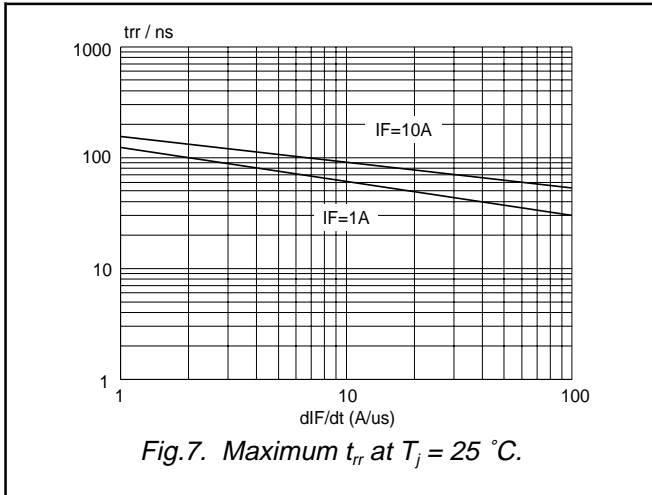

Rectifier diodes  
ultrafast, rugged

BYV79EB series

**MECHANICAL DATA**

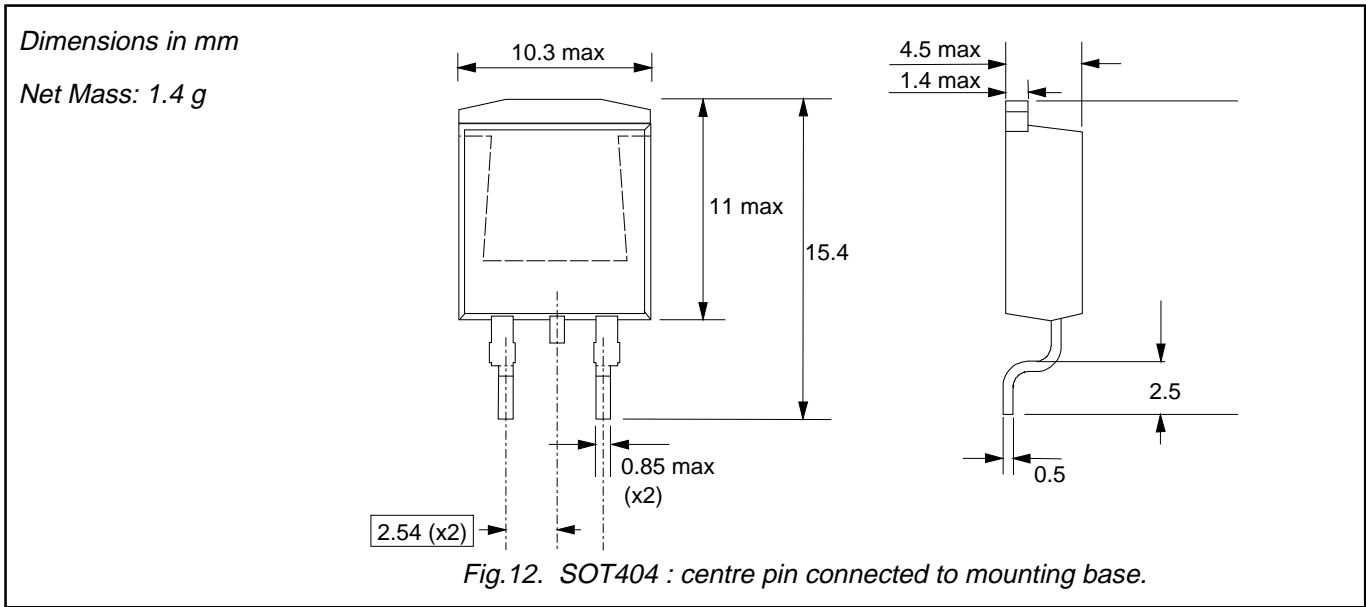

**MOUNTING INSTRUCTIONS**

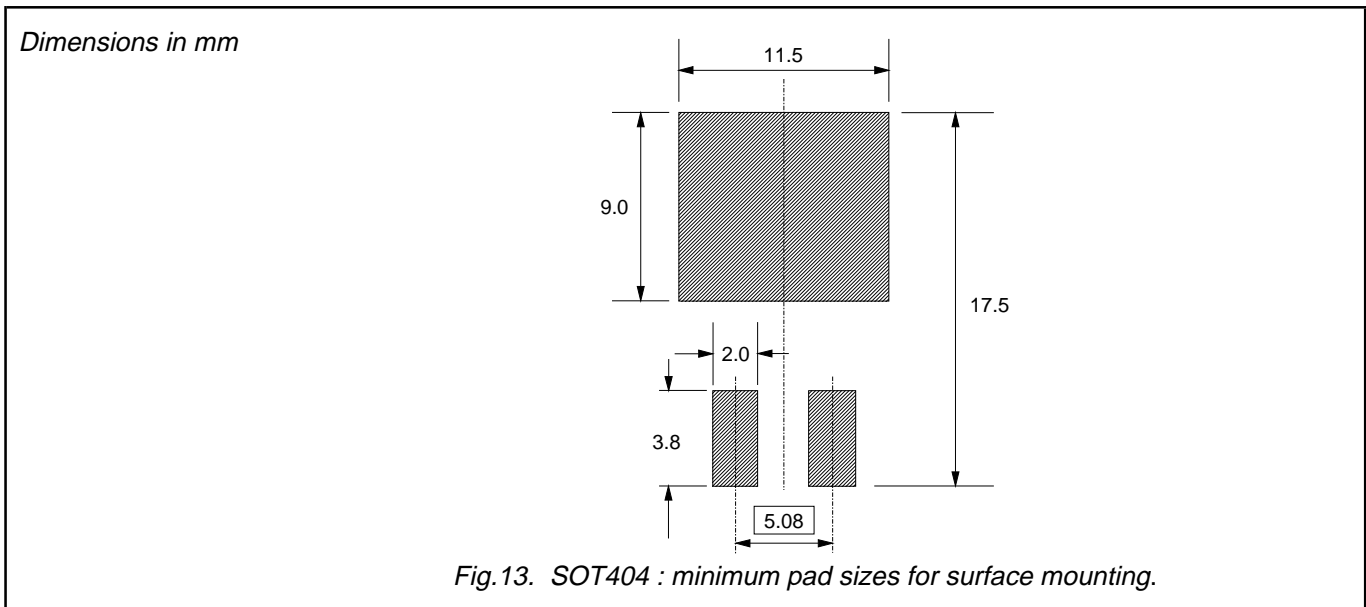

**Notes**

1. Plastic meets UL94 V0 at 1/8".

---

**Rectifier diodes  
ultrafast, rugged**

---

**BYV79EB series**

---

**DEFINITIONS**

<b>Data sheet status</b>	
Objective specification	This data sheet contains target or goal specifications for product development.
Preliminary specification	This data sheet contains preliminary data; supplementary data may be published later.
Product specification	This data sheet contains final product specifications.
<b>Limiting values</b>	
Limiting values are given in accordance with the Absolute Maximum Rating System (IEC 134). Stress above one or more of the limiting values may cause permanent damage to the device. These are stress ratings only and operation of the device at these or at any other conditions above those given in the Characteristics sections of this specification is not implied. Exposure to limiting values for extended periods may affect device reliability.	
<b>Application information</b>	
Where application information is given, it is advisory and does not form part of the specification.	
© Philips Electronics N.V. 1998	
All rights are reserved. Reproduction in whole or in part is prohibited without the prior written consent of the copyright owner.	
The information presented in this document does not form part of any quotation or contract, it is believed to be accurate and reliable and may be changed without notice. No liability will be accepted by the publisher for any consequence of its use. Publication thereof does not convey nor imply any license under patent or other industrial or intellectual property rights.	

**LIFE SUPPORT APPLICATIONS**

These products are not designed for use in life support appliances, devices or systems where malfunction of these products can be reasonably expected to result in personal injury. Philips customers using or selling these products for use in such applications do so at their own risk and agree to fully indemnify Philips for any damages resulting from such improper use or sale.

---

**Rectifier diodes  
ultrafast, rugged**

---

**BYV79EB series**

---

**DEFINITIONS**

<b>Data sheet status</b>	
Objective specification	This data sheet contains target or goal specifications for product development.
Preliminary specification	This data sheet contains preliminary data; supplementary data may be published later.
Product specification	This data sheet contains final product specifications.
<b>Limiting values</b>	
Limiting values are given in accordance with the Absolute Maximum Rating System (IEC 134). Stress above one or more of the limiting values may cause permanent damage to the device. These are stress ratings only and operation of the device at these or at any other conditions above those given in the Characteristics sections of this specification is not implied. Exposure to limiting values for extended periods may affect device reliability.	
<b>Application information</b>	
Where application information is given, it is advisory and does not form part of the specification.	
© Philips Electronics N.V. 1998	
All rights are reserved. Reproduction in whole or in part is prohibited without the prior written consent of the copyright owner.	
The information presented in this document does not form part of any quotation or contract, it is believed to be accurate and reliable and may be changed without notice. No liability will be accepted by the publisher for any consequence of its use. Publication thereof does not convey nor imply any license under patent or other industrial or intellectual property rights.	

**LIFE SUPPORT APPLICATIONS**

These products are not designed for use in life support appliances, devices or systems where malfunction of these products can be reasonably expected to result in personal injury. Philips customers using or selling these products for use in such applications do so at their own risk and agree to fully indemnify Philips for any damages resulting from such improper use or sale.