



Product Description

Sirenza Microdevices' SNA-500 is a GaAs monolithic broad-band amplifier in die form. This amplifier provides 19dB of gain when biased at 65mA and 5.0V.

External DC decoupling capacitors determine low frequency response. The use of an external resistor allows for bias flexibility and stability.

These unconditionally stable amplifiers are designed for use as general purpose 50 ohm gain blocks. Its small size (0.4mm x 0.4mm) and gold metallization make it an ideal choice for use in hybrid circuits.

The SNA-500 is available in gel paks at 100 devices per container. Also available in packaged form (SNA-576 and SNA-586).

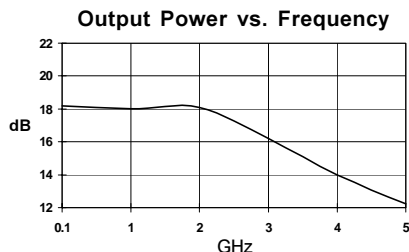

SNA-500

DC-3 GHz, Cascadable GaAs MMIC Amplifier

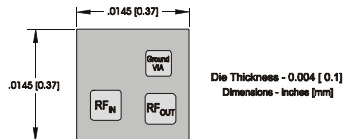

Product Features

- Cascadable 50 Ohm Gain Block
- 19dB Gain, +18dBm P1dB
- 1.5:1 Input and Output VSWR
- Operates From Single Supply
- Chip Back Is Ground

Applications

- PA Driver Amplifier
- Cellular, PCS, GSM, UMTS
- IF Amplifier
- Wireless Data, Satellite

Symbol	Parameter	Frequency	Units	Min.	Typ.	Max.
P _{1dB}	Output Power at 1dB Compression	850 MHz	dBm		17.6	
		1950 MHz	dBm		18.4	
		2400 MHz	dBm		18.4	
OIP ₃	Output Third Order Intercept Point	850 MHz	dBm		32.5	
		1950 MHz	dBm		31.6	
		2400 MHz	dBm		31.6	
S ₂₁	Small Signal Gain	850 MHz	dB		19.6	
		1950 MHz	dB		18.1	
		2400 MHz	dB		17.4	
Bandwidth	(Determined by S ₁₁ , S ₂₂ Values)		MHz		5000	
VSWR _{IN}	Input VSWR	DC-5000 MHz	-		1.4:1	
VSWR _{OUT}	Output VSWR	DC-5000 MHz	-		1.4:1	
S ₁₂	Reverse Isolation	850 MHz	dB		22.3	
		1950 MHz	dB		21.6	
		2400 MHz	dB		21.3	
NF	Noise Figure	1950 MHz	dB		4.0	
V _D	Device Operating Voltage		V	4.4	4.9	5.4
I _D	Device Operating Current		mA	58	65	72
R _{TH} j-b	Thermal Resistance (junction -backsided)		° C/W		200	

Test Conditions: V_S = 8 V, I_D = 65 mA Typ., OIP₃ Tone Spacing = 1 MHz, P_{out} per tone = 0 dBm
R_{BIAS} = 47 Ohms, T_L = 25°C, Z_S = Z_L = 50 Ohms

The information provided herein is believed to be reliable at press time. Sirenza Microdevices assumes no responsibility for inaccuracies or omissions. Sirenza Microdevices assumes no responsibility for the use of this information, and all such information shall be entirely at the user's own risk. Prices and specifications are subject to change without notice. No patent rights or licenses to any of the circuits described herein are implied or granted to any third party. Sirenza Microdevices does not authorize or warrant any Sirenza Microdevices product for use in life-support devices and/or systems. Copyright 2001 Sirenza Microdevices, Inc. All worldwide rights reserved.

Typical Performance at 25 °C (V_{ds} = 5.0V, I_{ds} = 65mA)

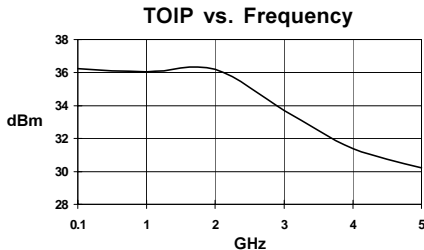
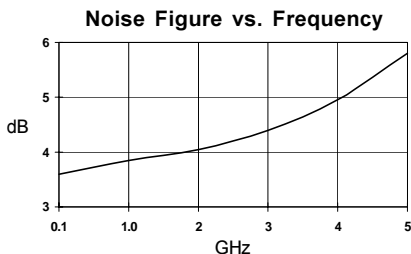
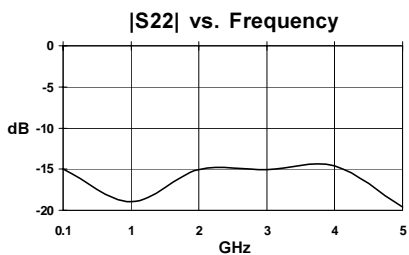
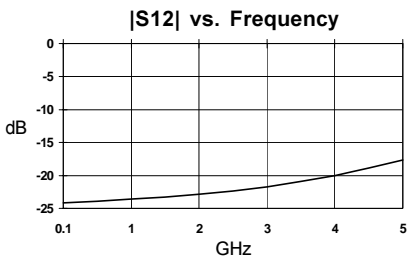
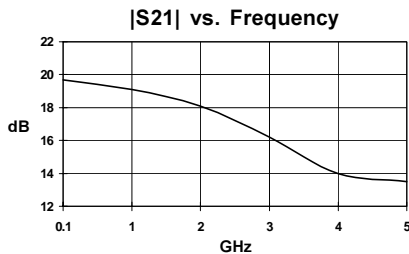
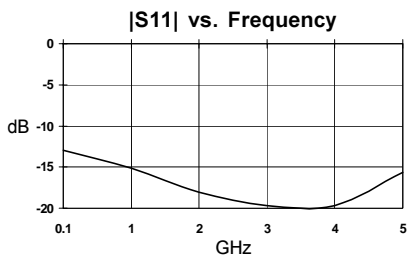

Absolute Maximum Ratings

Parameter	Absolute Limit
Max. Device Current (I _D)	130 mA
Max. Device Voltage (V _D)	6 V
Max. RF Input Power	+23 dBm
Max. Junction Temp. (T _J)	+200°C
Operating Temp. Range (T _I)	-40°C to +85°C
Max. Storage Temp.	+150°C

Operation of this device beyond any one of these limits may cause permanent damage. For reliable continuous operation, the device voltage and current must not exceed the maximum operating values specified in the table on page one.

Bias Conditions should also satisfy the following expression:

$$I_D V_D < (T_J - T_I) / R_{TH} \text{ j-l}$$

Typical Application Circuit

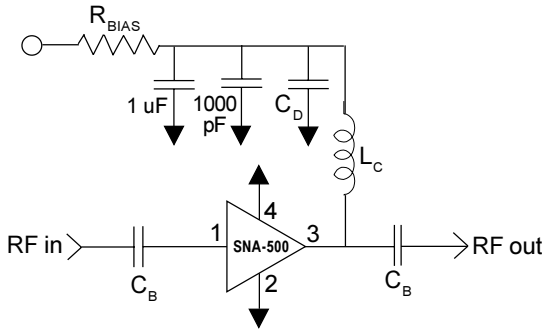

Application Circuit Element Values

Reference Designator	Frequency (Mhz)				
	500	850	1950	2400	3500
C _B	220 pF	100 pF	68 pF	56 pF	39 pF
C _D	100 pF	68 pF	22 pF	22 pF	15 pF
L _C	68 nH	33 nH	22 nH	18 nH	15 nH

Recommended Bias Resistor Values for I_D=65mA

$$R_{BIAS} = (V_S - V_D) / I_D$$

Supply Voltage(V _S)	8 V	9 V	10 V	12 V
R _{BIAS}	47 Ω	62 Ω	82 Ω	110 Ω

Note: R_{BIAS} provides DC bias stability over temperature.

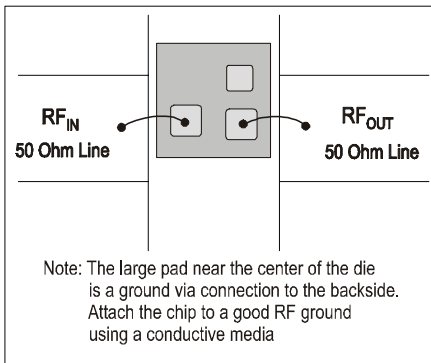

Suggested Bonding Arrangement
(above configuration used for S-parameter data)

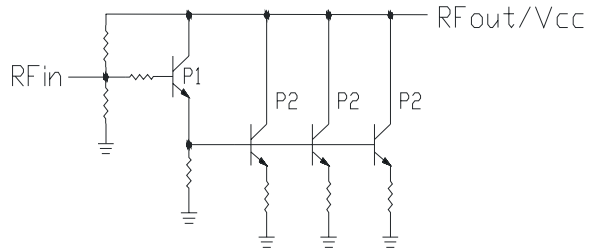

Simplified Schematic of MMIC

For recommended handling, die attach, and bonding methods, see the following application note at www.sirenza.com.

AN-041 (PDF) Handling of Unpackaged Die



Caution: ESD sensitive

Appropriate precautions in handling, packaging and testing devices must be observed.

Part Number Ordering Information

Part Number	Gel Pack
SNA-500	100 pcs. per pack

Die are shipped per Sirenza application note AN-039 Visual Criteria For Unpackaged Die