

**19A, 100V, 0.100 Ohm, N-Channel Power MOSFET**

This is an N-Channel enhancement mode silicon gate power field effect transistor designed for applications such as switching regulators, switching converters, motor drivers, relay drivers, and drivers for high power bipolar switching transistors requiring high speed and low gate drive power. This type can be operated directly from integrated circuits.

Formerly developmental type TA9854.

**Ordering Information**

PART NUMBER	PACKAGE	BRAND
BUZ21	TO-220AB	BUZ21

NOTE: When ordering, use the entire part number.

**Features**

- 19A, 100V
- $r_{DS(ON)} = 0.100\Omega$
- SOA is Power Dissipation Limited
- Nanosecond Switching Speeds
- Linear Transfer Characteristics
- High Input Impedance
- Majority Carrier Device
- Related Literature
  - TB334 "Guidelines for Soldering Surface Mount Components to PC Boards"

**Symbol**

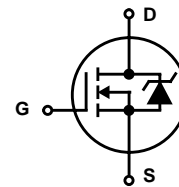

**Packaging**

**JEDEC TO-220AB**

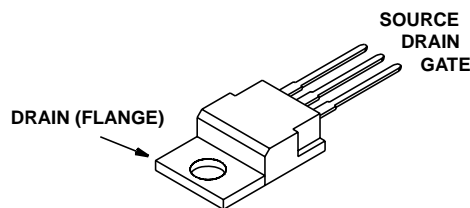

# BUZ21

## Absolute Maximum Ratings $T_C = 25^\circ\text{C}$ , Unless Otherwise Specified

	BUZ21	UNITS
Drain to Source Breakdown Voltage (Note 1) . . . . .	100	V
Drain to Gate Voltage ( $R_{GS} = 20k\Omega$ ) (Note 1) . . . . .	100	V
Continuous Drain Current, $T_C = 55^\circ\text{C}$ . . . . .	19	A
Pulsed Drain Current (Note 3) . . . . .	75	A
Gate to Source Voltage . . . . .	$\pm 20$	V
Maximum Power Dissipation . . . . .	75	W
Single Pulse Avalanche Energy Rating (Note 4) . . . . .	230	mJ
Linear Derating Factor . . . . .	0.6	W/ $^\circ\text{C}$
Operating and Storage Temperature . . . . .	-55 to 150	$^\circ\text{C}$
DIN Humidity Category - DIN 40040 . . . . .	E	
IEC Climatic Category - DIN IEC 68-1 . . . . .	55/150/56	
Maximum Temperature for Soldering		
Leads at 0.063in (1.6mm) from Case for 10s . . . . .	300	$^\circ\text{C}$
Package Body for 10s, See Techbrief 334 . . . . .	260	$^\circ\text{C}$

*CAUTION: Stresses above those listed in "Absolute Maximum Ratings" may cause permanent damage to the device. This is a stress only rating and operation of the device at these or any other conditions above those indicated in the operational sections of this specification is not implied.*

**NOTE:**

1.  $T_J = 25^\circ\text{C}$  to  $125^\circ\text{C}$ .

## Electrical Specifications $T_C = 25^\circ\text{C}$ , Unless Otherwise Specified

PARAMETER	SYMBOL	TEST CONDITIONS	MIN	TYP	MAX	UNITS
Drain to Source Breakdown Voltage	$BV_{DSS}$	$I_D = 250\mu\text{A}$ , $V_{GS} = 0\text{V}$	100	-	-	V
Gate to Threshold Voltage	$V_{GS(TH)}$	$V_{GS} = V_{DS}$ , $I_D = 1\text{mA}$ (Figure 9)	2.1	3	4	V
Zero Gate Voltage Drain Current	$I_{DSS}$	$T_J = 25^\circ\text{C}$ , $V_{DS} = 100\text{V}$ , $V_{GS} = 0\text{V}$	-	20	250	$\mu\text{A}$
		$T_J = 125^\circ\text{C}$ , $V_{DS} = 100\text{V}$ , $V_{GS} = 0\text{V}$	-	100	1000	$\mu\text{A}$
Gate to Source Leakage Current	$I_{GSS}$	$V_{GS} = 20\text{V}$ , $V_{DS} = 0\text{V}$	-	10	100	nA
Drain to Source On Resistance (Note 2)	$r_{DS(ON)}$	$I_D = 9\text{A}$ , $V_{GS} = 10\text{V}$ (Figure 8)	-	0.09	0.1	$\Omega$
Forward Transconductance (Note 2)	$g_{fs}$	$V_{DS} = 25\text{V}$ , $I_D = 9\text{A}$ (Figure 11)	4	8	-	S
Turn-On Delay Time	$t_{d(ON)}$	$V_{CC} = 30\text{V}$ , $I_D \approx 3\text{A}$ , $V_{GS} = 10\text{V}$ , $R_{GS} = 50\Omega$ , $R_L = 10\Omega$ . (Figures 16, 17)	-	30	45	ns
Rise Time	$t_r$		-	50	75	ns
Turn-Off Delay Time	$t_{d(OFF)}$		-	170	220	ns
Fall Time	$t_f$		-	80	110	ns
Input Capacitance	$C_{ISS}$	$V_{DS} = 25\text{V}$ , $V_{GS} = 0\text{V}$ , $f = 1\text{MHz}$ (Figure 10)	-	1500	2000	pF
Output Capacitance	$C_{OSS}$		-	450	700	pF
Reverse Transfer Capacitance	$C_{RSS}$		-	150	240	pF
Thermal Resistance Junction to Case	$R_{\theta JC}$		$\leq 1.67$			$^\circ\text{C/W}$
Thermal Resistance Junction to Ambient	$R_{\theta JA}$		$\leq 75$			$^\circ\text{C/W}$

## Source to Drain Diode Specifications

PARAMETER	SYMBOL	TEST CONDITIONS	MIN	TYP	MAX	UNITS
Continuous Source to Drain Current	$I_{SD}$	$T_C = 25^\circ\text{C}$	-	-	19	A
Pulsed Source to Drain Current	$I_{SDM}$	$T_C = 25^\circ\text{C}$	-	-	75	A
Source to Drain Diode Voltage	$V_{SD}$	$T_J = 25^\circ\text{C}$ , $I_{SD} = 38\text{A}$ , $V_{GS} = 0\text{V}$	-	1.5	2.1	V
Reverse Recovery Time	$t_{rr}$	$T_J = 25^\circ\text{C}$ , $I_{SD} = 19\text{A}$ , $dI_{SD}/dt = 100\text{A}/\mu\text{s}$ , $V_R = 30\text{V}$	-	200	-	ns
Reverse Recovery Charge	$Q_{RR}$		-	0.25	-	$\mu\text{C}$

**NOTES:**

2. Pulse Test: Pulse width  $\leq 300\mu\text{s}$ , duty cycle  $\leq 2\%$ .
3. Repetitive rating: pulse width limited by maximum junction temperature. See Transient Thermal Impedance curve (Figure 3).
4.  $V_{DD} = 25\text{V}$ , starting  $T_J = 25^\circ\text{C}$ ,  $L = 440\mu\text{H}$ ,  $R_G = 50\Omega$ ,  $I_{PEAK} = 28\text{A}$ . (See Figures 14 and 15).

Typical Performance Curves Unless Otherwise Specified

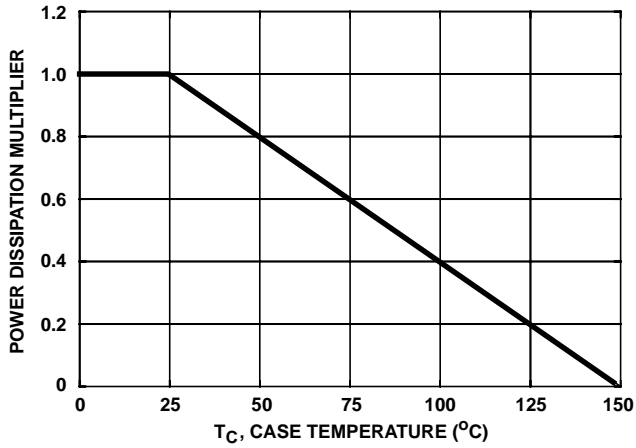

FIGURE 1. NORMALIZED POWER DISSIPATION vs CASE TEMPERATURE

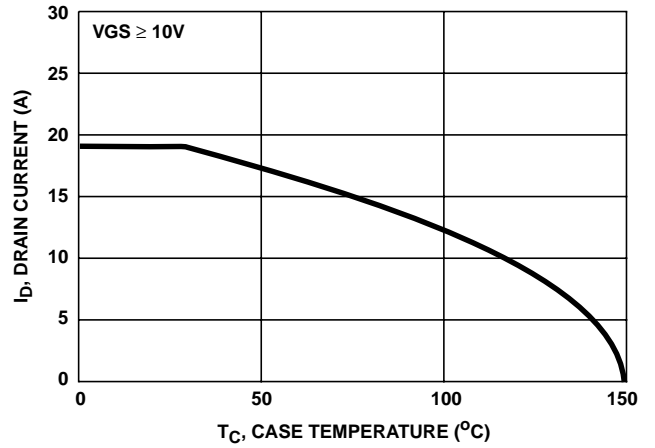

FIGURE 2. MAXIMUM CONTINUOUS DRAIN CURRENT vs CASE TEMPERATURE

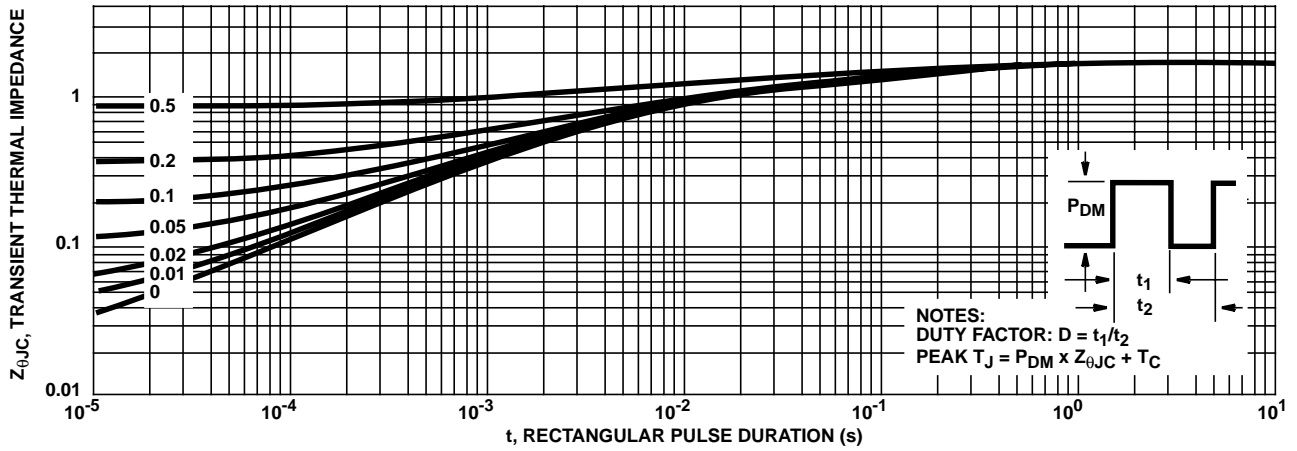

FIGURE 3. MAXIMUM TRANSIENT THERMAL IMPEDANCE

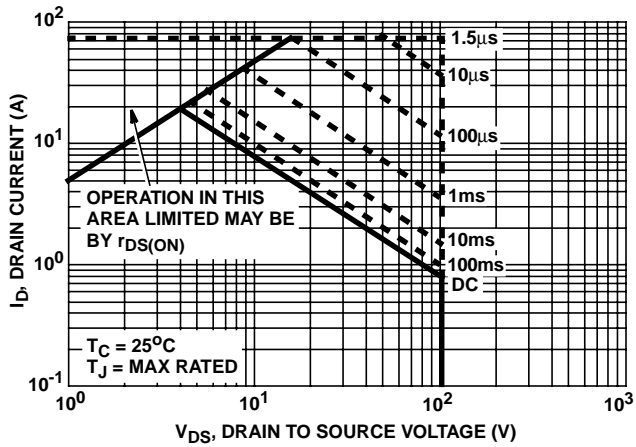

FIGURE 4. FORWARD BIAS SAFE OPERATING AREA

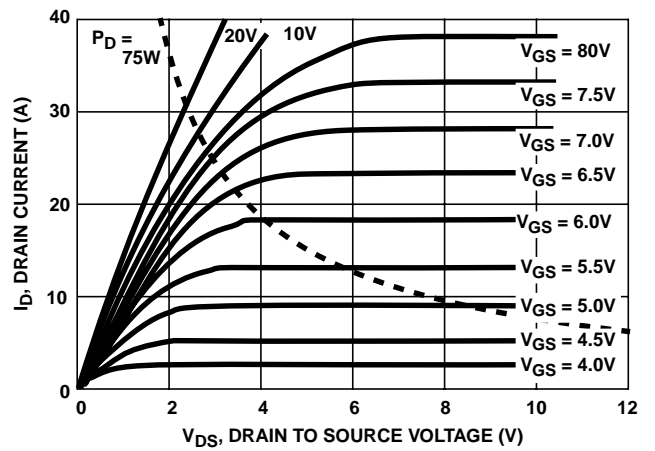

FIGURE 5. OUTPUT CHARACTERISTICS

Typical Performance Curves Unless Otherwise Specified (Continued)

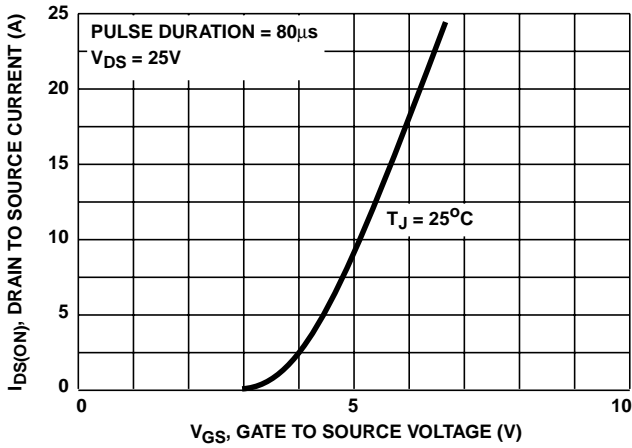

FIGURE 6. TRANSFER CHARACTERISTICS

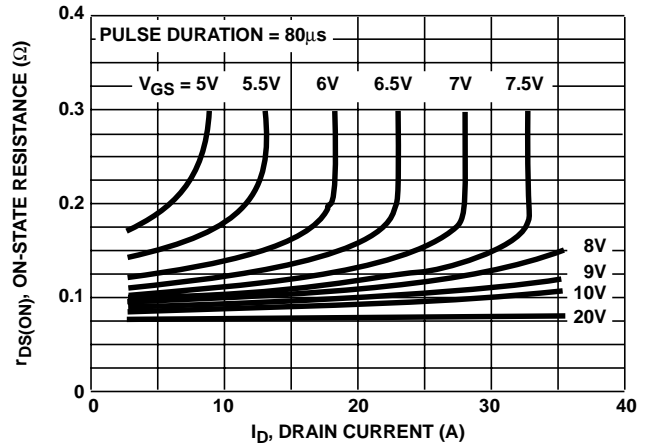

FIGURE 7. DRAIN TO SOURCE ON RESISTANCE vs GATE VOLTAGE AND DRAIN CURRENT

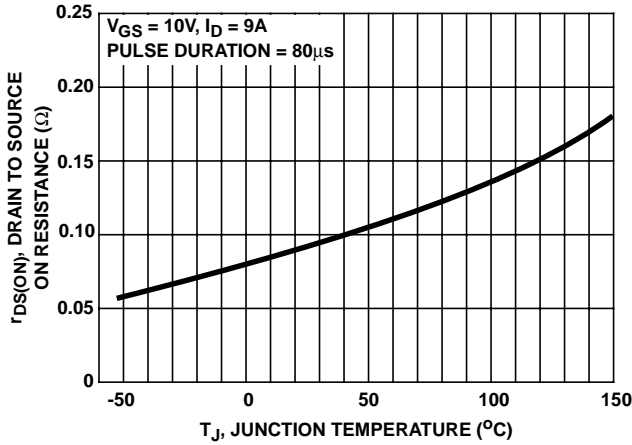

FIGURE 8. DRAIN TO SOURCE ON RESISTANCE vs JUNCTION TEMPERATURE

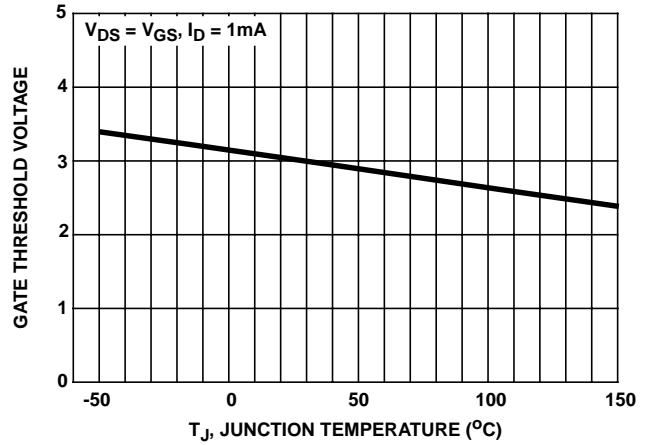

FIGURE 9. GATE THRESHOLD VOLTAGE vs JUNCTION TEMPERATURE

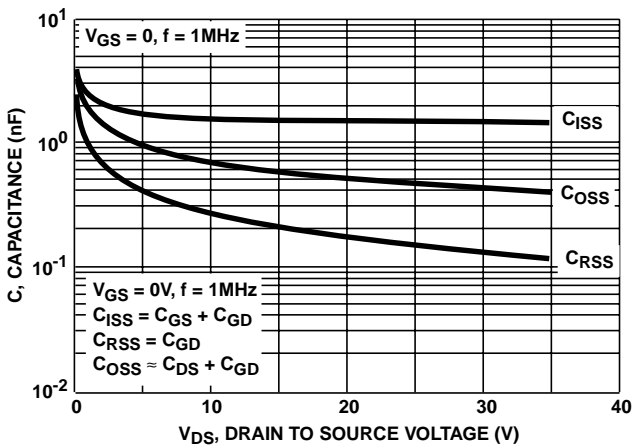

FIGURE 10. CAPACITANCE vs DRAIN TO SOURCE VOLTAGE

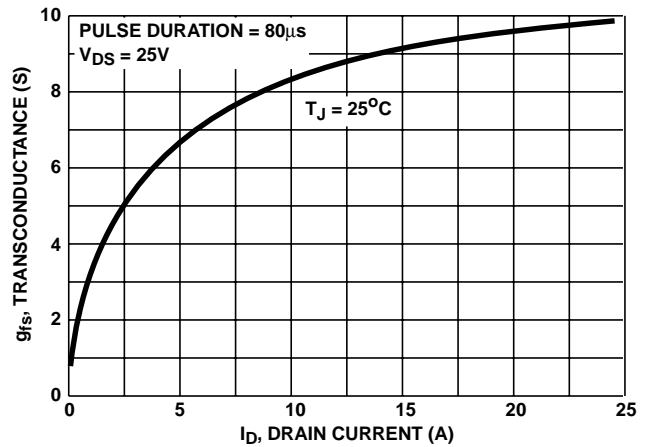

FIGURE 11. TRANSCONDUCTANCE vs DRAIN CURRENT

**Typical Performance Curves** Unless Otherwise Specified (Continued)

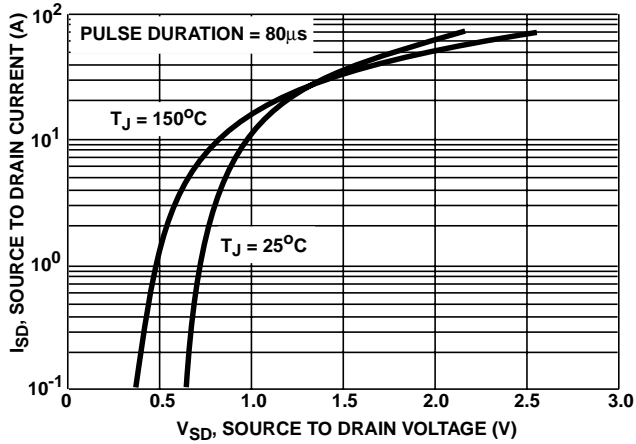

FIGURE 12. SOURCE TO DRAIN DIODE VOLTAGE

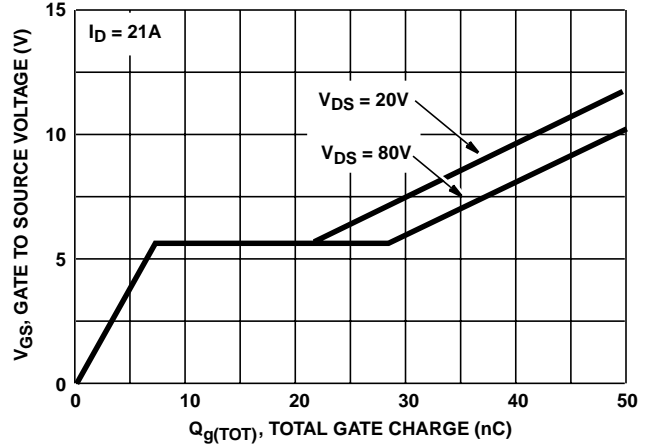

FIGURE 13. GATE TO SOURCE VOLTAGE vs GATE CHARGE

**Test Circuits and Waveforms**

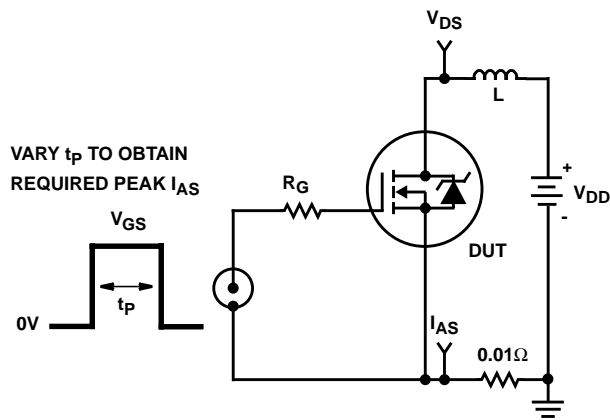

FIGURE 14. UNCLAMPED ENERGY TEST CIRCUIT

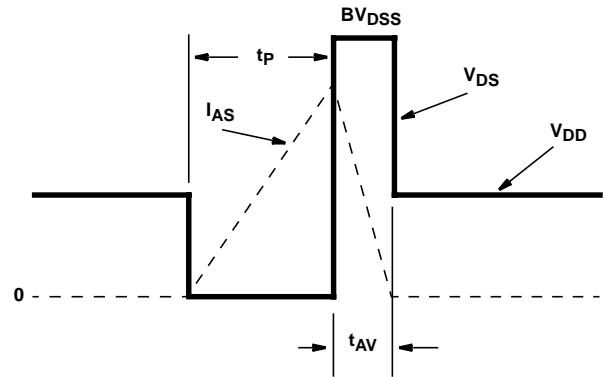

FIGURE 15. UNCLAMPED ENERGY WAVEFORMS

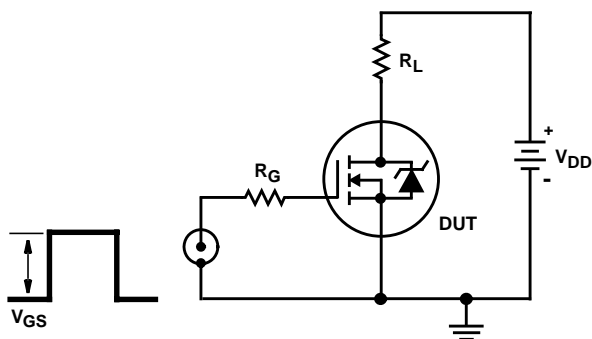

FIGURE 16. SWITCHING TIME TEST CIRCUIT

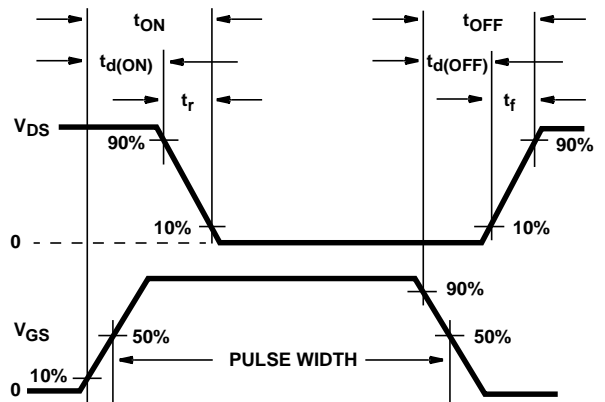

FIGURE 17. RESISTIVE SWITCHING WAVEFORMS

Test Circuits and Waveforms (Continued)

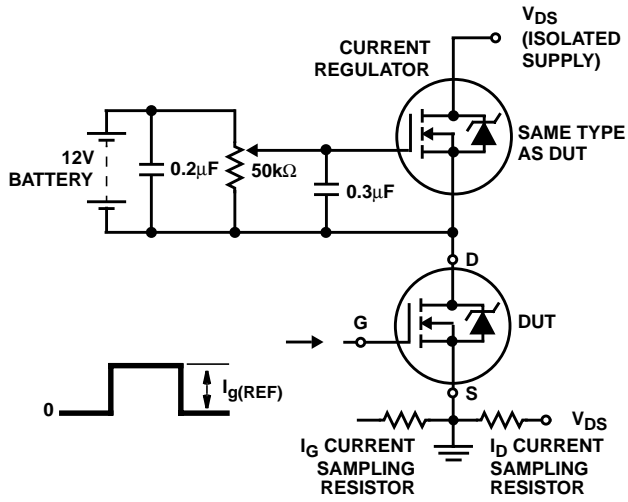

FIGURE 18. GATE CHARGE TEST CIRCUIT

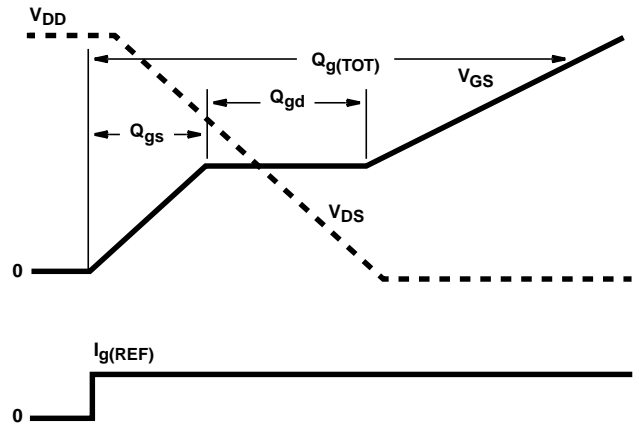

FIGURE 19. GATE CHARGE WAVEFORMS