



SP2525

Low ESR Cap. & Low Power High-speed CMOS LDO

DESCRIPTION

The SP2525 series are highly precise, low noise, positive voltage LDO regulators manufactured using CMOS processes. The series achieves high ripple rejection and low dropout and consists of a standard voltage source, an error correction, current limiter and a phase compensation circuit plus a driver transistor. The series is also compatible with low ESR ceramic capacitors which give added output stability.

This stability can be maintained even during load fluctuations due to the excellent transient response of the series. The current limiter's feedback circuit also operates as a short protect for the output current limiter and the output pin.

The SP2525 family is compatible with low ESR capacitors. The current limiter's feedback circuit also operates as a short protect for the output current limiter. The SOT-23-3L / SOT-353 packages are available for portable electronic equipment.

APPLICATIONS

- Battery Power Equipment
- Cellular Phone
- Digital Cameras
- Computer Disk Drivers
- Portable games
- Communication tools

FEATURES

- ◆ Highly Accurate $\pm 2\%$
- ◆ Maximum operation voltage 7V.
- ◆ Dropout Voltage 200mV @ 150mA (3.3V type)
- ◆ High Ripple Rejection 45dB (10 KHz)
- ◆ Low Power Consumption 25 μ A (TYP.)
- ◆ Minimum Output Current 300mA
- ◆ Standby Current less than 0.1 μ A
- ◆ Internal protector current limiter and short
- ◆ Small packages SOT-23-3L / SOT-353 , and other required

PIN CONFIGURATION

SOT-23-3L

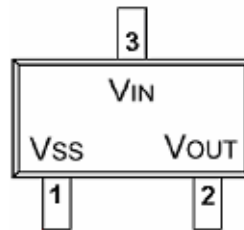

SOT-353

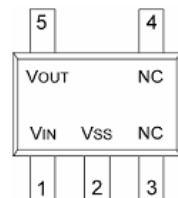

PART MARKING

SOT-23-3L

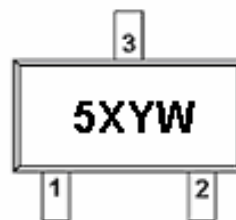

X : Voltage Code
Y : Year Code
W : Week Code

SOT-353



X : Voltage Code
Y : Year Code
W : Week Code



SP2525

Low ESR Cap. & Low Power High-speed CMOS LDO

APPLICATION CIRCUIT

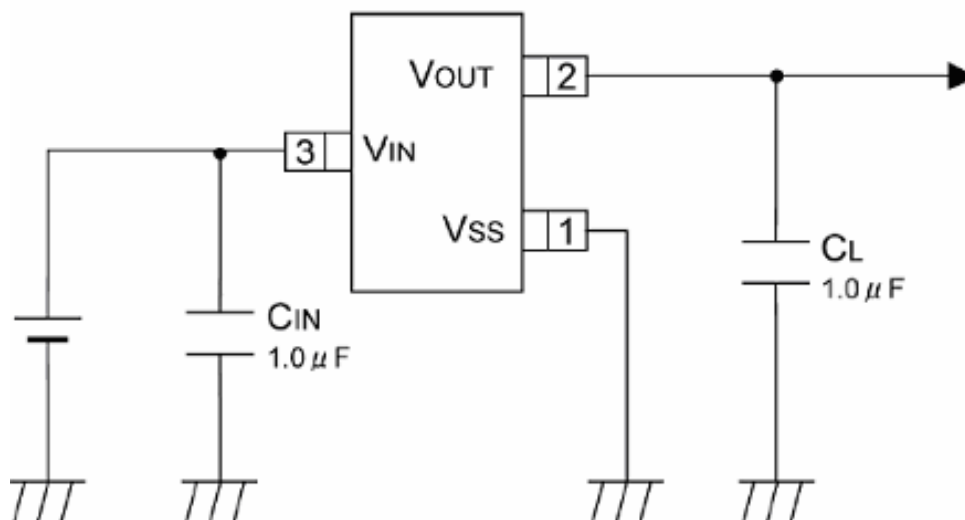

PIN DESCRIPTION

SOT-23-3L	SOT-353	Symbol	Description
1	2	VSS	Ground
2	5	VOUT	Voltage Output
3	1	VIN	Voltage Input

ORDERING INFORMATION (X : Voltage Code ; Y : Year Code ; W: Week Code)

Part Number	Package	Part Marking
SP2525XS23RG	SOT-23-3L	5XYW
SP2525XS35RG	SOT-353	5XYW

※ Week Code : A ~ Z (1 ~ 26) ; a ~ z (27 ~ 52)

※ SP2525XS23RG : Tape Reel ; Pb – Free

※ SP2525XS35RG : Tape Reel ; Pb – Free

VOLTAGE CODE INFORMATION

Voltage Code (X)	Output Voltage (V)
D	1.8
K	2.5
N	2.8
S	3.3



SP2525

Low ESR Cap. & Low Power High-speed CMOS LDO

BLOCK DIAGRAM

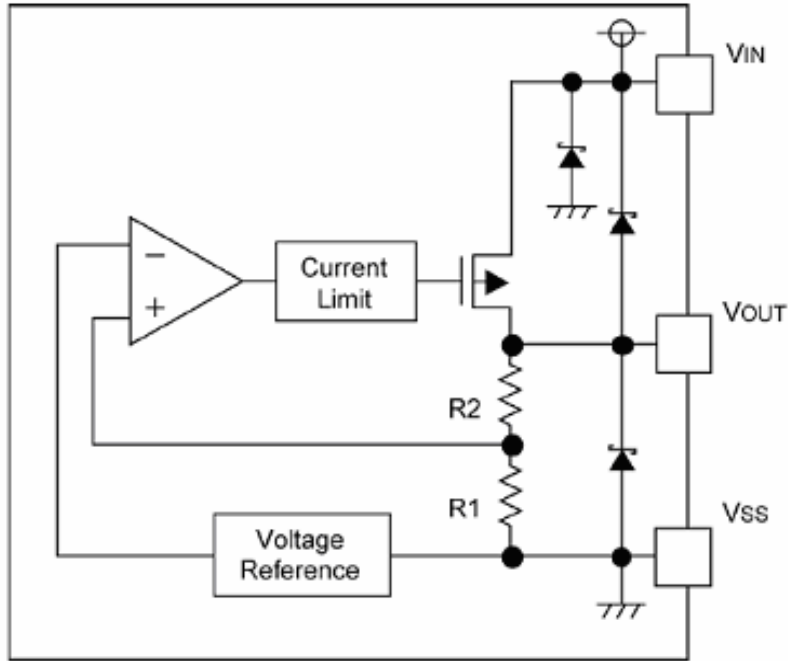

TEST CIRCUIT

Circuit 1 :

Circuit 2 :

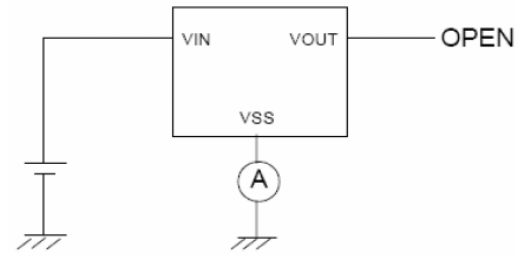
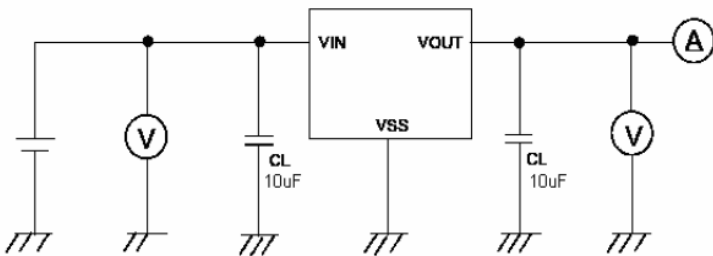

ABSOLUTE MAXIMUM RATINGS

(TA=25°C Unless otherwise specified)

Parameter	Symbol	Value	Unit
Input Voltage	V _{IN}	7	V _{IN}
Output Current	I _{OUT}	500	I _{OUT}
Output Voltage	V _{OUT}	V _{SS} -0.3 ~ V _{IN} +0.3	V _{OUT}
Thermal Resistance	θ _{JA}	SOT-23-3L	120
		SOT-353	105
Power Dissipation	P _D	SOT-23-3L	1250
		SOT-353	950
Operation Junction Temperature Range	T _J	-40 ~ +85	T _J
Storage Temperature Range	T _{STG}	-55 ~ +125	T _{STG}



SP2525

Low ESR Cap. & Low Power High-speed CMOS LDO

ELECTRICAL CHARACTERISTICS

(TA=25°C , Unless otherwise specified)

Parameter	Symbol	Conditions	Min.	Typ.	Max.	Unit
Output Voltage	V _{OUT(E)1}	V _{IN} =V _{OUT} +1.0V, I _{OUT} = 30mA	x 0.98	V _{OUT(T)}	x 1.02	V
Maximum Output Current	I _{OUT}	V _{IN} ≥V _{OUT} +1.0 V	300			mA
Load Regulation	ΔV _{OUT 2}	V _{IN} =V _{OUT} +1.0 V 1.0 mA ≤I _{OUT} ≤ 300 mA			V _{OUT(T)} X1.0%	V
Dropout Voltage	V _{dif 1}	I _{OUT} =30mA	E1			mV
	V _{dif 2}	I _{OUT} =150mA	E2			mV
Supply Current	I _{DD}	V _{IN} =5V	15	25	40	uA
Line Regulations	V _{OUT} / (ΔV _{IN} - V _{OUT})	V _{OUT} +0.5 V ≤V _{IN} ≤7V I _{OUT} =30 mA		0.025	0.1	%/V
Input Voltage	V _{IN}		1.8		7	V
Output Voltage Temperature Characteristics	ΔV _{OUT} / (ΔT _{opr} - V _{OUT})	V _{IN} =V _{OUT} +1.0V, I _{OUT} =10mA -40°C ≤ T _{opr} ≤ 85°C		± 100		ppm/°C
Ripple-Rejection	PSRR	V _{IN} =V _{OUT} +1.0V, f=1 kHz V _{rip} =0.5V _{rms} , I _{OUT} =60 mA		55		dB
Ripple-Rejection	PSRR	V _{IN} =V _{OUT} +1.0V, f=10 kHz V _{rip} =0.5V _{rms} , I _{OUT} =60 mA		45		dB
Short Current	I _{short}	V _{IN} =V _{OUT} +1.0V, V _{OUT} =V _{SS}		50		mA

(NOTE 1) V_{OUT(T)} = Specified Output Voltage

(NOTE 2) V_{OUT(E)} = Effective Output Voltage (I.e. The output voltage when "V_{OUT(T)}+1.0V" is provided at the V_{IN} pin while maintaining a certain I_{OUT} value.)

(NOTE 3) V_{dif} = {V_{IN 1} (NOTE5) + V_{OUT 1} (NOTE4)}

(NOTE 4) V_{OUT1} = A voltage equal to 98% of the Output Voltage whenever an amply stabilized I_{OUT} {V_{OUT(T)} + 1.0V} is input.

(NOTE 5) V_{IN 1} = The Input Voltage when V_{OUT 1} appears as Input Voltage is gradually decreased.

(NOTE 6) Unless otherwise stated, V_{IN} = V_{OUT(T)}+1.0V

DROPOUT VOLTAGE LIST (E1 / E2)

V _{OUT} (TA=25°C)	E1 (I _{OUT} =30mA)		E2 (I _{OUT} =150mA)	
	TYP	MAX	TYP	MAX
1.8	180	210	350	400
2.5	60	100	240	290
2.8	60	100	220	270
3.3	50	90	200	250



SP2525

Low ESR Cap. & Low Power High-speed CMOS LDO

PERFORMANCE CHARACTERISTICS (Voltage Code = Z ; 2.5V)

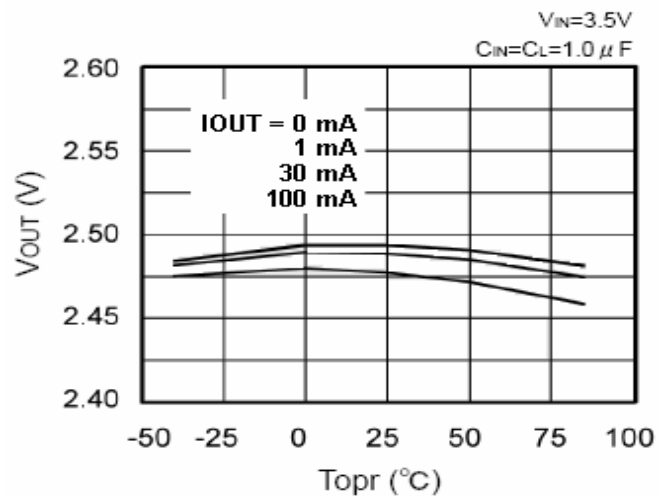
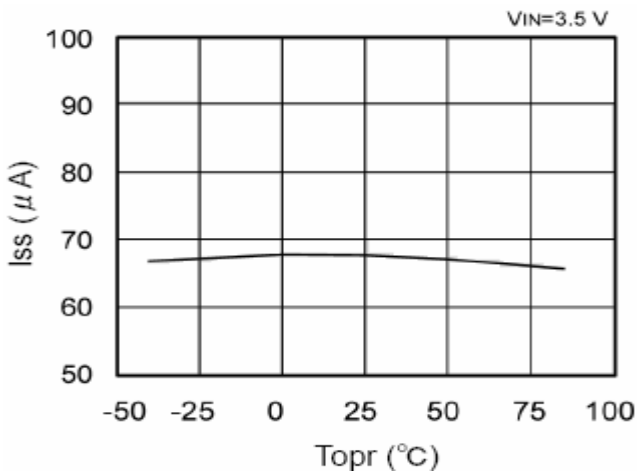
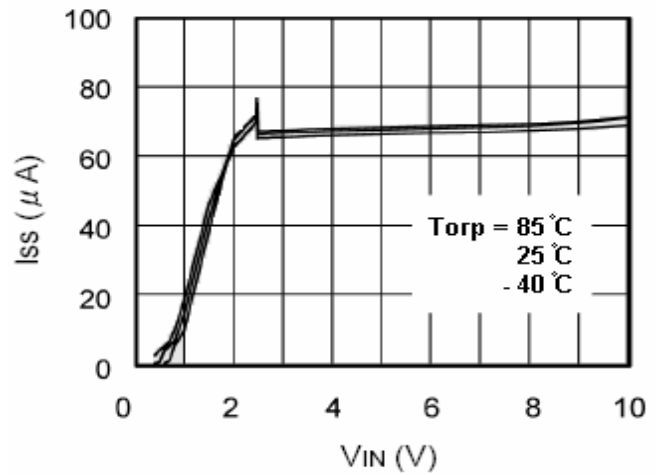
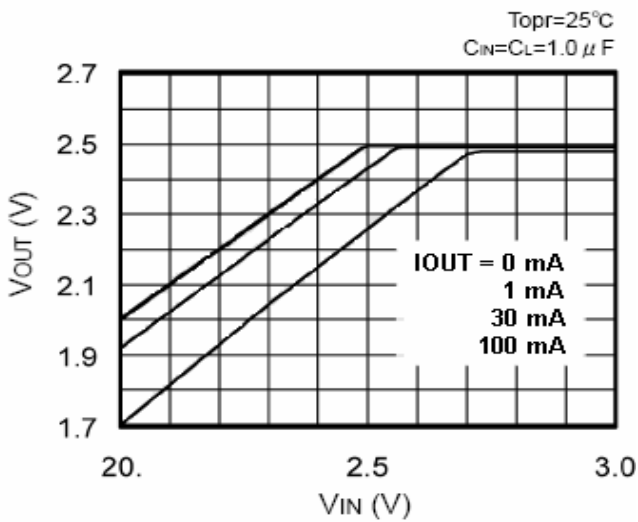
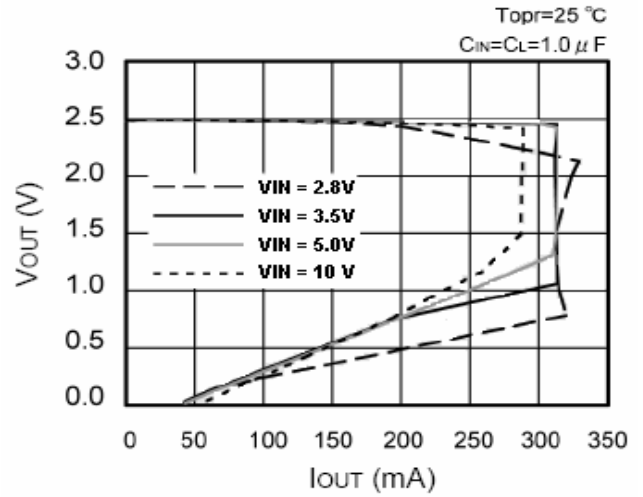
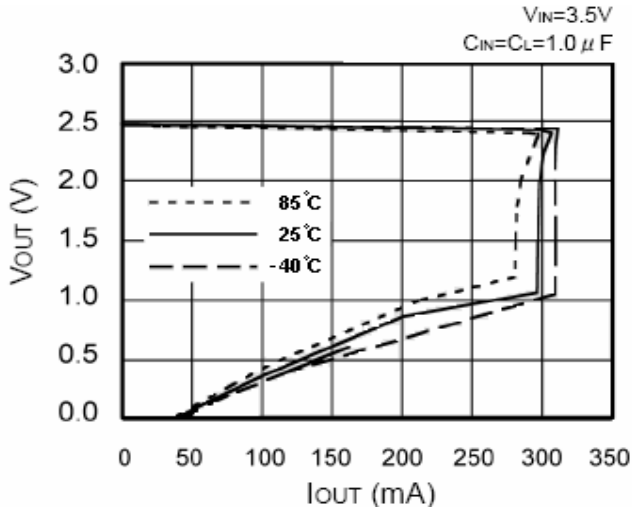



SP2525

Low ESR Cap. & Low Power High-speed CMOS LDO

PERFORMANCE CHARACTERISTICS (Voltage Code = Z ; 2.5V)

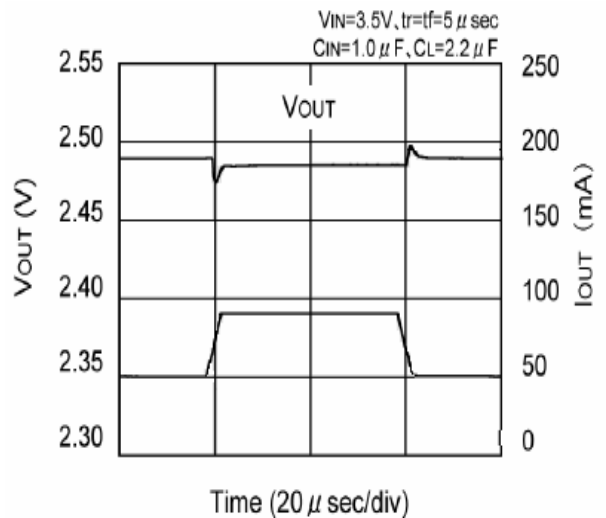
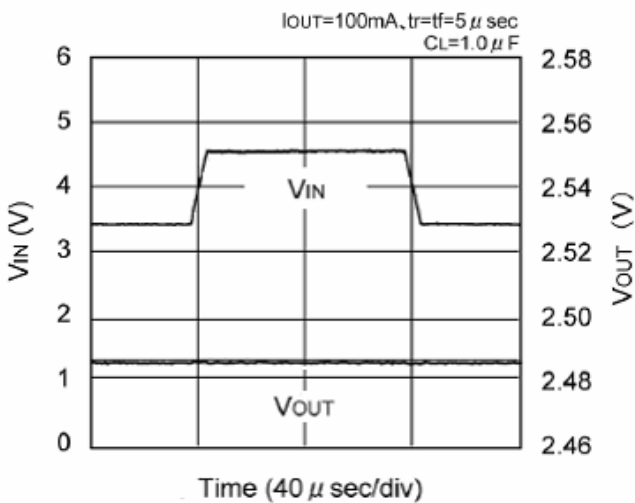
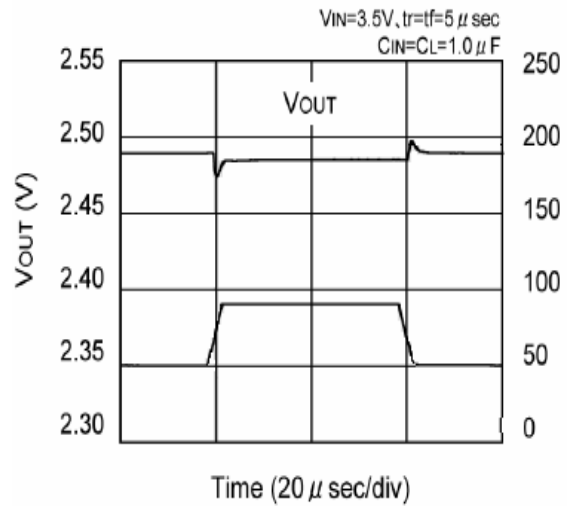
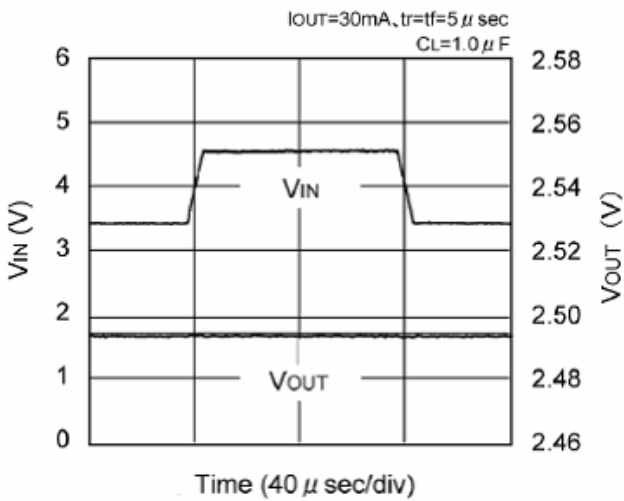
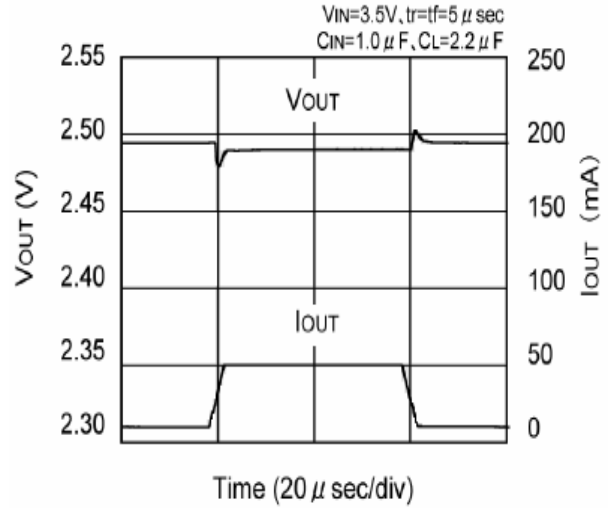
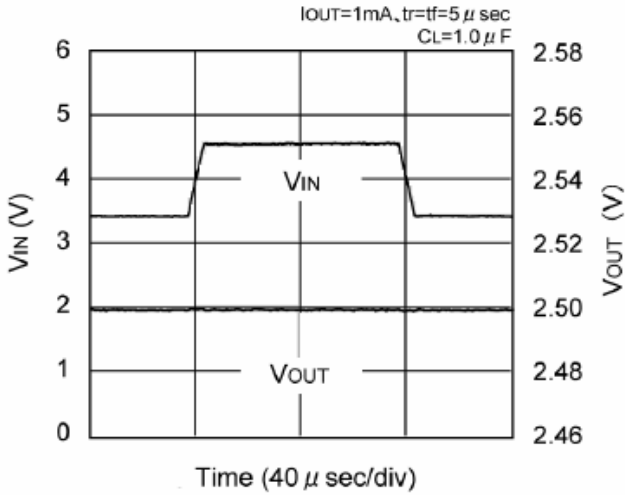



SP2525

Low ESR Cap. & Low Power High-speed CMOS LDO

PERFORMANCE CHARACTERISTICS (Voltage Code = Z ; 2.5V)

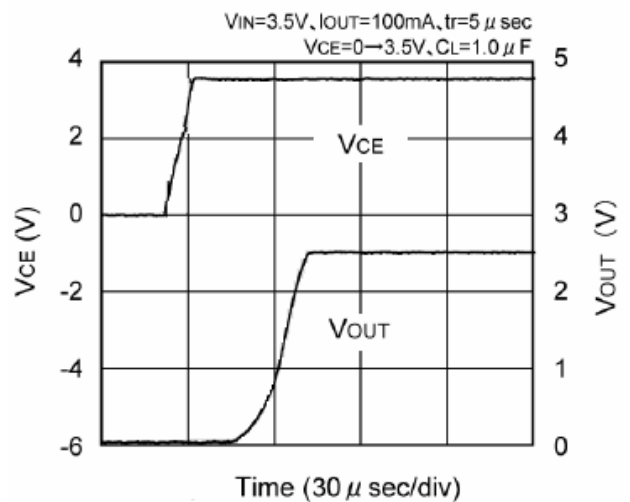
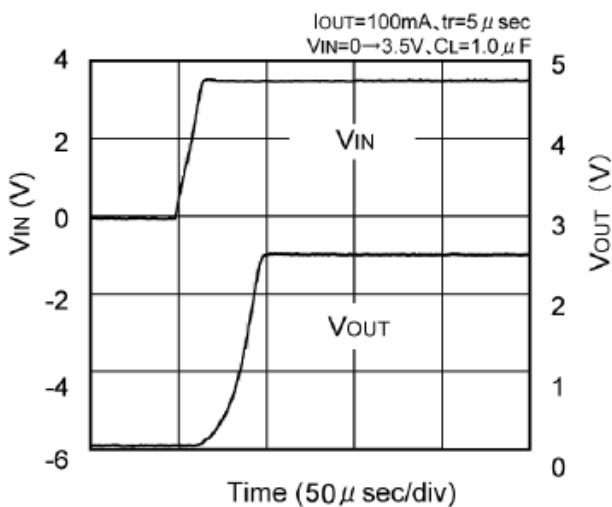
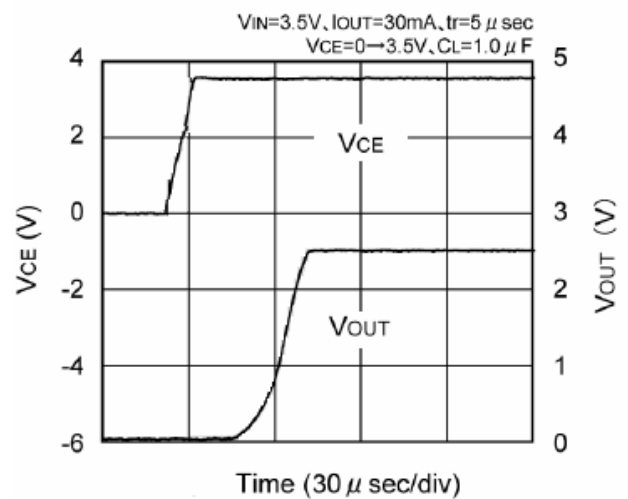
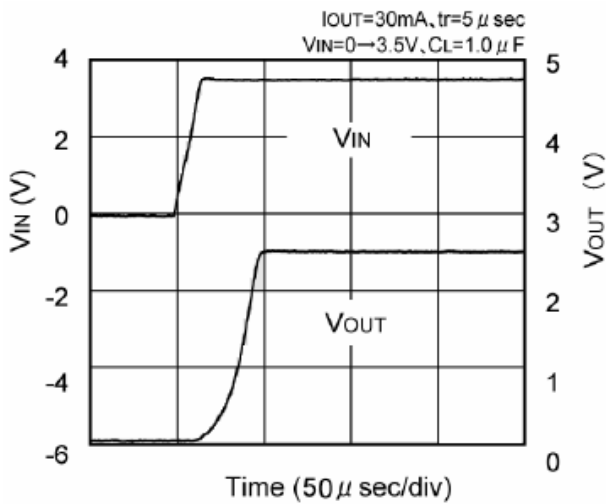
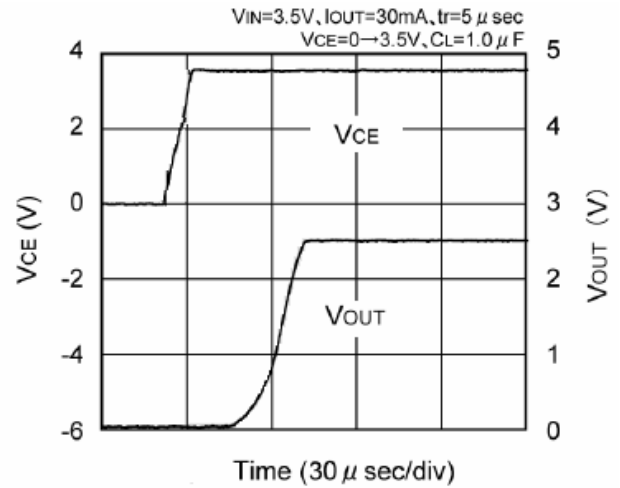
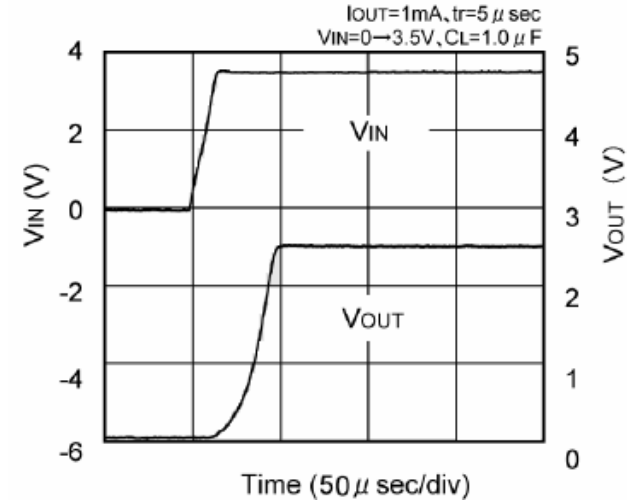



SP2525

Low ESR Cap. & Low Power High-speed CMOS LDO

SOT-23-3L PACKAGE OUTLINE

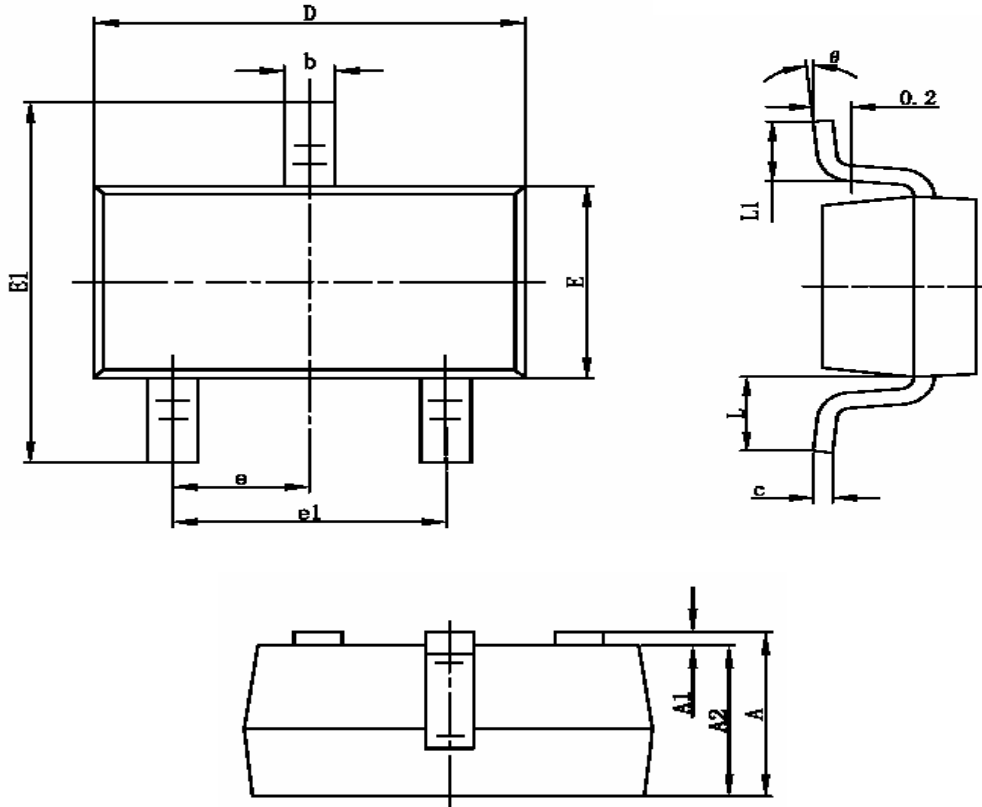

Symbol	Dimensions In Millimeters		Dimensions In Inches	
	Min	Max	Min	Max
A	1.050	1.250	0.041	0.049
A1	0.000	0.100	0.000	0.004
A2	1.050	1.150	0.041	0.045
b	0.300	0.400	0.012	0.016
c	0.100	0.200	0.004	0.008
D	2.820	3.020	0.111	0.119
E	1.500	1.700	0.059	0.067
E1	2.650	2.950	0.104	0.116
e	0.950TYP		0.037TYP	
e1	1.800	2.000	0.071	0.079
L	0.700REF		0.028REF	
L1	0.300	0.600	0.012	0.024
θ	0°	8°	0°	8°



SP2525

Low ESR Cap. & Low Power High-speed CMOS LDO

SOT-353 PACKAGE OUTLINE

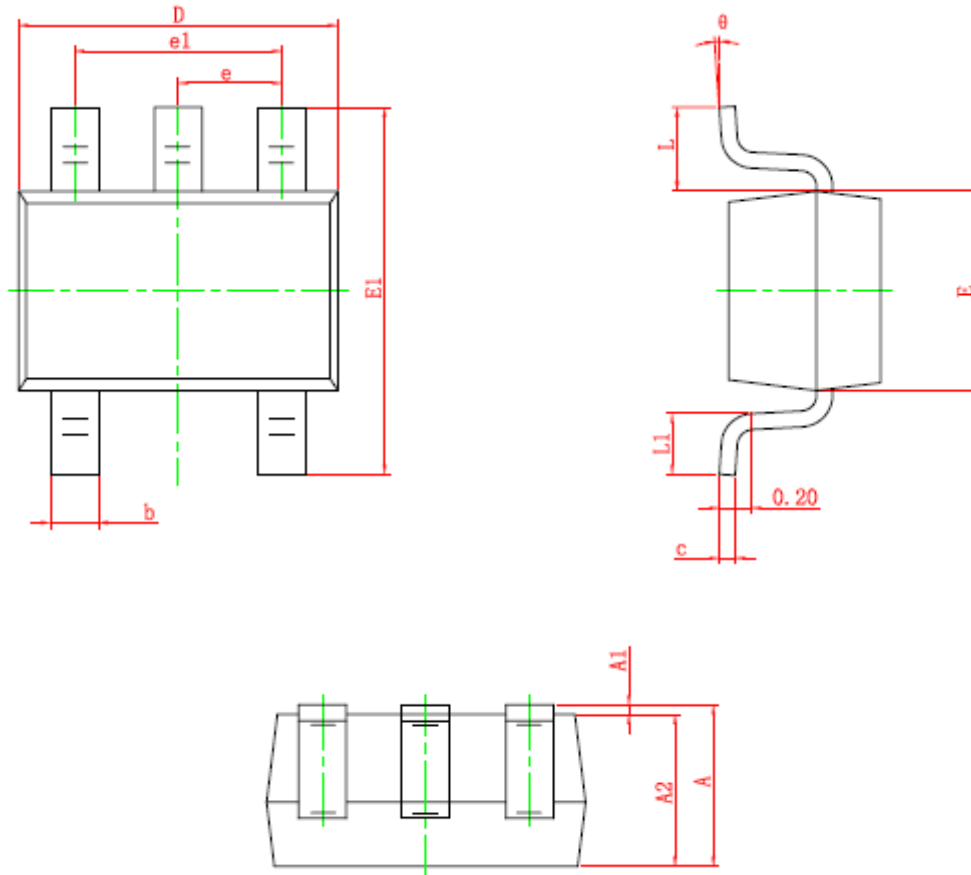

Symbol	Dimensions In Millimeters		Dimensions In Inches	
	Min	Max	Min	Max
A	0.900	1.100	0.035	0.043
A1	0.000	0.100	0.000	0.004
A2	0.900	1.000	0.035	0.039
b	0.150	0.350	0.006	0.014
c	0.080	0.150	0.003	0.006
D	2.000	2.200	0.079	0.087
E	1.150	1.350	0.045	0.053
E1	2.150	2.450	0.085	0.096
e	0.650 TYP		0.026 TYP	
e1	1.200	1.400	0.047	0.055
L	0.525 REF		0.021 REF	
L1	0.260	0.460	0.010	0.018
θ	0°	8°	0°	8°



SP2525

Low ESR Cap. & Low Power High-speed CMOS LDO

Information provided is alleged to be exact and consistent. SYNC Power Corporation presumes no responsibility for the penalties of use of such information or for any violation of patents or other rights of third parties which may result from its use. No license is granted by allegation or otherwise under any patent or patent rights of SYNC Power Corporation. Conditions mentioned in this publication are subject to change without notice. This publication surpasses and replaces all information previously supplied. SYNC Power Corporation products are not authorized for use as critical components in life support devices or systems without express written approval of SYNC Power Corporation.

©The SYNC Power logo is a registered trademark of SYNC Power Corporation

©2004 SYNC Power Corporation – Printed in Taiwan – All Rights Reserved

SYNC Power Corporation

9F-5, No.3-2, Park Street

NanKang District (NKSP), Taipei, Taiwan 115

Phone: 886-2-2655-8178

Fax: 886-2-2655-8468

©<http://www.syncpower.com>