

Features

- Frequency Range: LO & RF 50 – 2200 MHz, IF 10 – 600 MHz
- L.O. Drive: +13 dBm
- Industry Standard SMT package
- Available in Tape-and -Reel
- Low Cost

Description

The MXJ-2201-13 is medium-high drive level, surface mount mixer designed for applications that require small, low cost and highly reliable surface mount components. This mixer is a double/double-balanced design for wideband, high dynamic range use in communications up and down-converter applications.

SURFACE MOUNT MIXER



Specifications

Parameter	Min	Typ	Max	Min	Typ	Max
Frequency Range (MHz)	50		1500	1500		2200
Conversion Loss (dB)		7.0	7.5		7.5	9
LO – RF Isolation (dB)	22	35		18	28	
LO – IF Isolation (dB)	21	26		17	26	
IIP ₃ (dBm)		24			21	

Absolute Maximum Ratings

Parameter	Maximum
RF Power	+ 20 dBm
Operating Temperature	-50 to +80 °C
Storage Temperature	-65 to +100 °C
Re-flow Temperature	+ 240 °C

Notes: Test Conditions-LO +13dBm, RF -10 dBm, IF 30 MHz
 Frequency Range-RF/LO 50 – 2200 MHz, IF 10– 600 MHz
 Typical values represent Mid-band performance @ 25°C.

Schematic

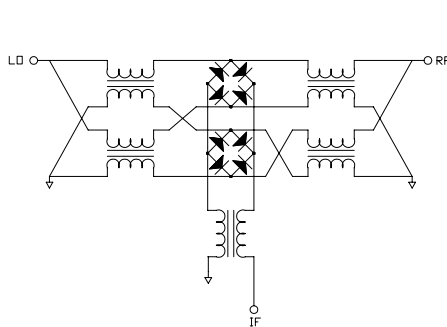

Package – S05

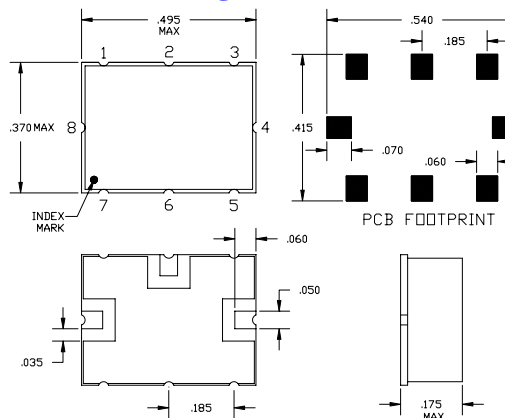

Pin Functions

Function	Pin
LO INPUT	8
RF INPUT	4
IF OUTPUT	6
GROUND	1,2,3,5,7

Typical Test Data – Conversion Loss

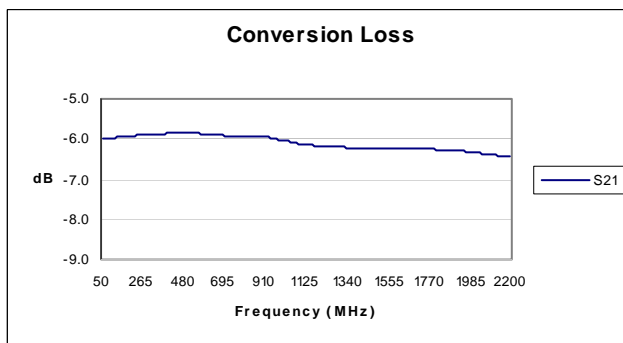

Typical Test Data – LO-RF and LO-IF Isolation

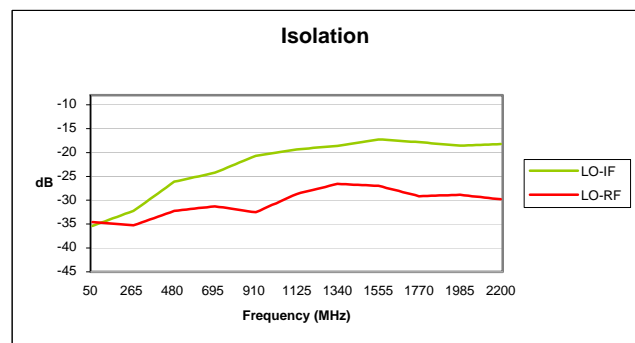

Specifications and information on this data sheet are subject to change without notice..