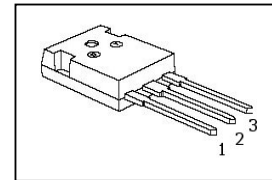

CoolMOS™ Power Transistor
Features

- New revolutionary high voltage technology
- Intrinsic fast-recovery body diode
- Extremely low reverse recovery charge
- Ultra low gate charge
- Extreme dv/dt rated
- High peak current capability
- Periodic avalanche rated
- Qualified according to JEDEC¹⁾ for target applications
- Pb-free lead plating; RoHS compliant

Product Summary

V_{DS}	600	V
$R_{DS(on),max}$	0.118	Ω
I_D	34	A

PG-TO247

Type	Package	Ordering Code	Marking
SPW35N60CFD	PG-TO247	Q67045A5053	35N60CFD

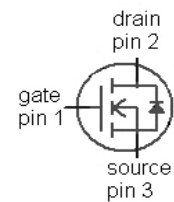
Maximum ratings, at $T_j=25\text{ °C}$, unless otherwise specified

Parameter	Symbol	Conditions	Value	Unit
Continuous drain current	I_D	$T_C=25\text{ °C}$	34.1	A
		$T_C=100\text{ °C}$	21.6	
Pulsed drain current ²⁾	$I_{D,pulse}$	$T_C=25\text{ °C}$	85	
Avalanche energy, single pulse	E_{AS}	$I_D=10\text{ A}$, $V_{DD}=50\text{ V}$	1300	mJ
Avalanche energy, repetitive t_{AR} ^{2),3)}	E_{AR}	$I_D=20\text{ A}$, $V_{DD}=50\text{ V}$	1	
Avalanche current, repetitive t_{AR} ^{2),3)}	I_{AR}		20	A
Drain source voltage slope	dv/dt	$I_D=34.1\text{ A}$, $V_{DS}=480\text{ V}$, $T_j=125\text{ °C}$	80	V/ns
Reverse diode dv/dt	dv/dt	$I_S=34.1\text{ A}$, $V_{DS}=480\text{ V}$, $T_j=125\text{ °C}$	40	V/ns
Maximum diode commutation speed	di/dt	$T_j=125\text{ °C}$	600	A/ μ s
Gate source voltage	V_{GS}	static	± 20	V
		AC ($f>1\text{ Hz}$)	± 30	
Power dissipation	P_{tot}	$T_C=25\text{ °C}$	313	W
Operating and storage temperature	T_j, T_{stg}		-55 ... 150	$^{\circ}\text{C}$

Parameter	Symbol	Conditions	Values			Unit
			min.	typ.	max.	
Thermal characteristics						
Thermal resistance, junction - case	R_{thJC}		-	-	0.4	K/W
Thermal resistance, junction - ambient	R_{thJA}	leaded	-	-	62	
Soldering temperature, wave soldering	T_{sold}	1.6 mm (0.063 in.) from case for 10 s	-	-	260	°C

Electrical characteristics, at $T_j=25\text{ °C}$, unless otherwise specified

Static characteristics

Drain-source breakdown voltage	$V_{(BR)DSS}$	$V_{GS}=0\text{ V}, I_D=250\text{ }\mu\text{A}$	600	-	-	V
Avalanche breakdown voltage	$V_{(BR)DS}$	$V_{GS}=0\text{ V}, I_D=34.1\text{ A}$	-	700	-	
Gate threshold voltage	$V_{GS(th)}$	$V_{DS}=V_{GS}, I_D=1.9\text{ mA}$	3	4	5	
Zero gate voltage drain current	I_{DSS}	$V_{DS}=600\text{ V}, V_{GS}=0\text{ V}, T_j=25\text{ °C}$	-	4	-	μA
		$V_{DS}=600\text{ V}, V_{GS}=0\text{ V}, T_j=150\text{ °C}$	-	3300	-	
Gate-source leakage current	I_{GSS}	$V_{GS}=20\text{ V}, V_{DS}=0\text{ V}$	-	-	100	nA
Drain-source on-state resistance	$R_{DS(on)}$	$V_{GS}=10\text{ V}, I_D=21.6\text{ A}, T_j=25\text{ °C}$	-	0.10	0.118	Ω
		$V_{GS}=10\text{ V}, I_D=21.6\text{ A}, T_j=150\text{ °C}$	-	0.23	-	
Gate resistance	R_G	$f=1\text{ MHz}, \text{open drain}$	-	0.6	-	
Transconductance	g_{fs}	$ V_{DS} >2 I_D R_{DS(on)max}, I_D=21.6\text{ A}$	-	21	-	S

Parameter	Symbol	Conditions	Values			Unit
			min.	typ.	max.	

Dynamic characteristics

Input capacitance	C_{iss}	$V_{GS}=0\text{ V}, V_{DS}=25\text{ V},$ $f=1\text{ MHz}$	-	5060	-	pF
Output capacitance	C_{oss}		-	1400	-	
Reverse transfer capacitance	C_{rss}		-	52	-	
Effective output capacitance, energy related ⁴⁾	$C_{o(er)}$	$V_{GS}=0\text{ V}, V_{DS}=0\text{ V}$ to 480 V	-	162	-	
Effective output capacitance, time related ⁵⁾	$C_{o(tr)}$		-	299	-	
Turn-on delay time	$t_{d(on)}$	$V_{DD}=400\text{ V},$ $V_{GS}=10\text{ V}, I_D=34.1\text{ A},$ $R_G=3.3\ \Omega$	-	20	-	ns
Rise time	t_r		-	25	-	
Turn-off delay time	$t_{d(off)}$		-	65	-	
Fall time	t_f		-	12	-	

Gate Charge Characteristics

Gate to source charge	Q_{gs}	$V_{DD}=480\text{ V},$ $I_D=34.1\text{ A},$ $V_{GS}=0\text{ to }10\text{ V}$	-	36	-	nC
Gate to drain charge	Q_{gd}		-	87	-	
Gate charge total	Q_g		-	163	212	
Gate plateau voltage	$V_{plateau}$		-	7.2	-	V

¹⁾ J-STD20 and JESD22

²⁾ Pulse width t_p limited by $T_{j,max}$
³⁾ Repetitive avalanche causes additional power losses that can be calculated as $P_{AV}=E_{AR} \cdot f$.

⁴⁾ $C_{o(er)}$ is a fixed capacitance that gives the same stored energy as C_{oss} while V_{DS} is rising from 0 to 80% V_{DSS} .

⁵⁾ $C_{o(tr)}$ is a fixed capacitance that gives the same charging time as C_{oss} while V_{DS} is rising from 0 to 80% V_{DSS} .

Parameter	Symbol	Conditions	Values			Unit
			min.	typ.	max.	

Reverse Diode

Diode continuous forward current	I_S	$T_C=25\text{ }^\circ\text{C}$	-	-	34.1	A
Diode pulse current	$I_{S,pulse}$		-	-	85	
Diode forward voltage	V_{SD}	$V_{GS}=0\text{ V}, I_F=34.1\text{ A}, T_j=25\text{ }^\circ\text{C}$	-	1.0	1.2	V
Reverse recovery time	t_{rr}	$V_R=480\text{ V}, I_F=I_S, di_F/dt=100\text{ A}/\mu\text{s}$	-	180	-	ns
Reverse recovery charge	Q_{rr}		-	1.5	-	μC
Peak reverse recovery current	I_{rrm}		-	16	-	A

Typical Transient Thermal Characteristics

Symbol	Value	Unit	Symbol	Value	Unit
	typ.			typ.	
R_{th1}	0.00441	K/W	C_{th1}	0.00037	Ws/K
R_{th2}	0.00608		C_{th2}	0.00223	
R_{th3}	0.0341		C_{th3}	0.00315	
R_{th4}	0.0602		C_{th4}	0.0179	
R_{th5}	0.0884		C_{th5}	0.098	
			C_{th6}	4.4 ⁵⁾	

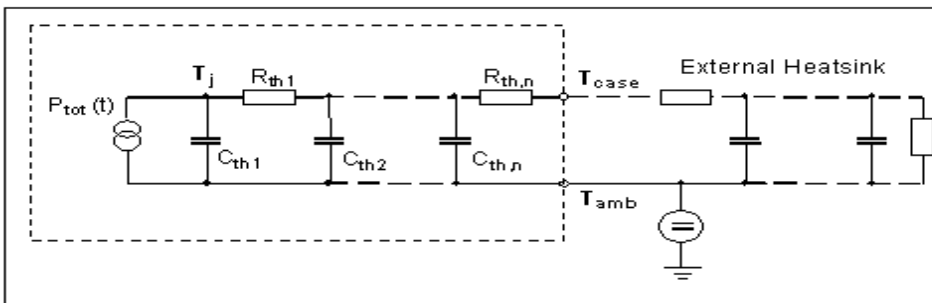

⁵⁾ C_{th6} models the additional heat capacitance of the package in case of non-ideal cooling. It is not needed if $R_{thCA}=0\text{ K/W}$.

1 Power dissipation

$P_{tot}=f(T_C)$

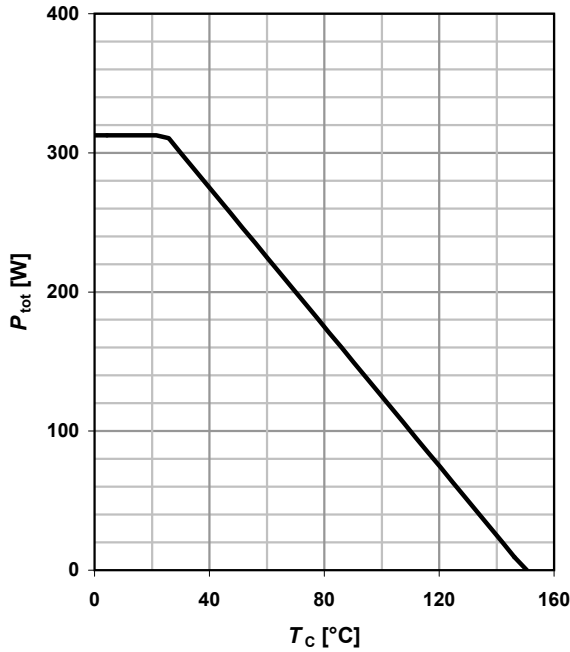

2 Safe operating area

$I_D=f(V_{DS}); T_C=25\text{ °C}; D=0$

parameter: t_p

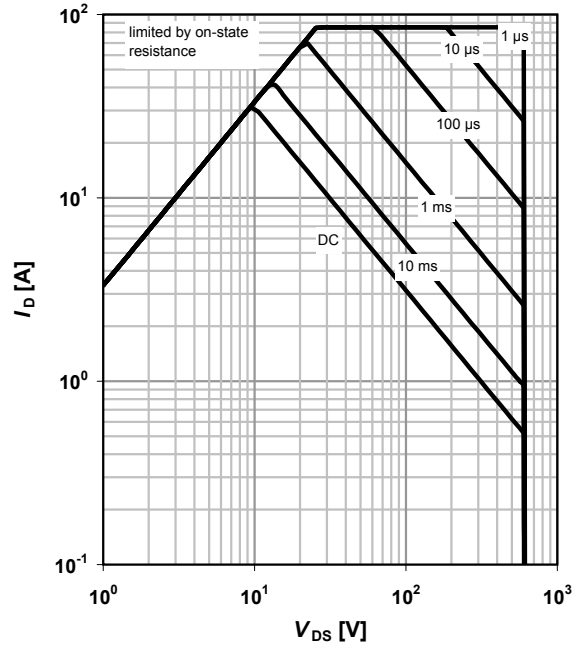

3 Max. transient thermal impedance

$I_D=f(V_{DS}); T_J=25\text{ °C}$

parameter: $D=t_p/T$

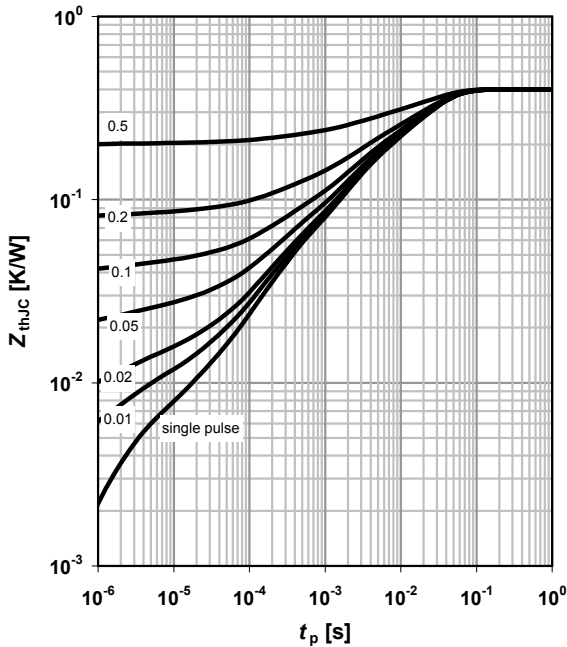

4 Typ. output characteristics

$I_D=f(V_{DS}); T_J=25\text{ °C}$

parameter: V_{GS}

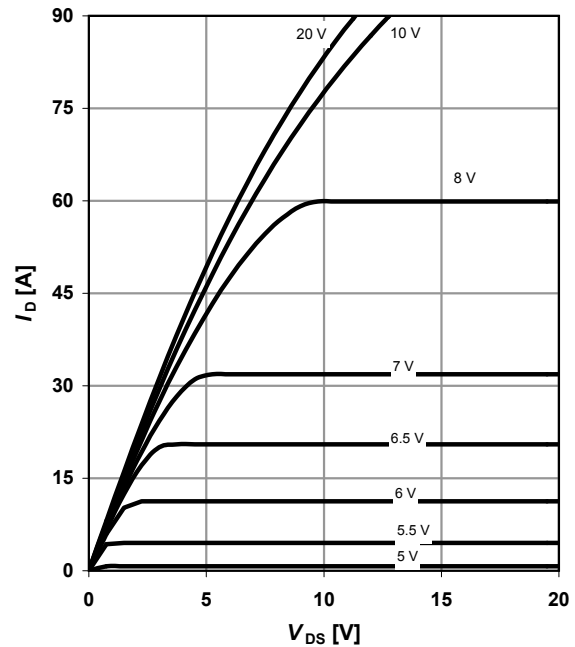

5 Typ. output characteristics

$I_D = f(V_{DS}); T_j = 150\text{ °C}$

parameter: V_{GS}

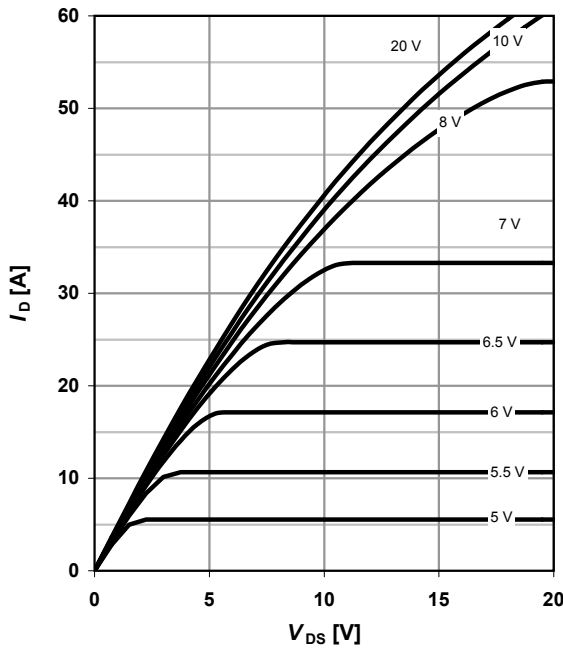

6 Typ. drain-source on-state resistance

$R_{DS(on)} = f(I_D); T_j = 150\text{ °C}$

parameter: V_{GS}

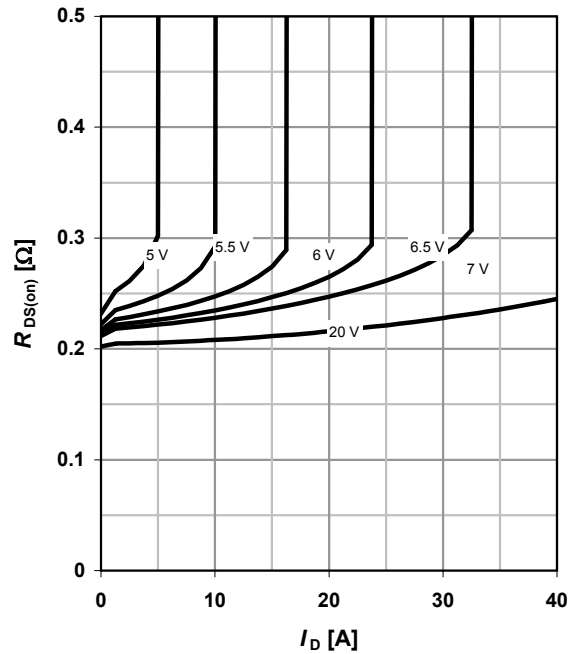

7 Drain-source on-state resistance

$R_{DS(on)} = f(T_j); I_D = 21.9\text{ A}; V_{GS} = 10\text{ V}$

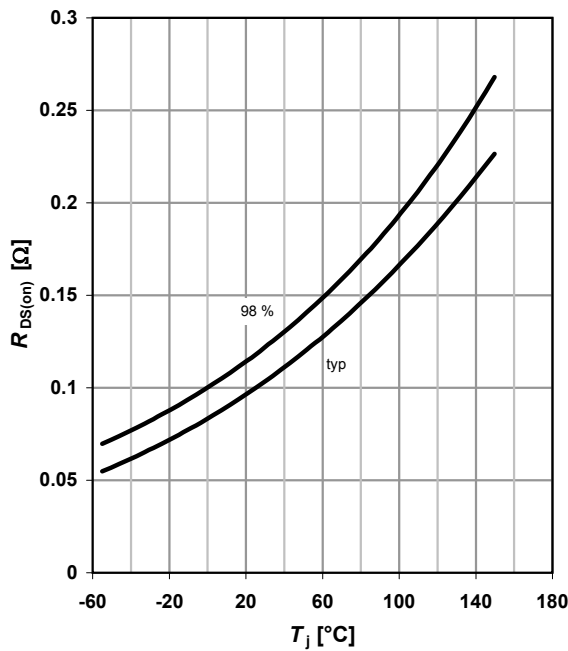

8 Typ. transfer characteristics

$I_D = f(V_{GS}); |V_{DS}| > 2|I_D|R_{DS(on)max}$

parameter: T_j

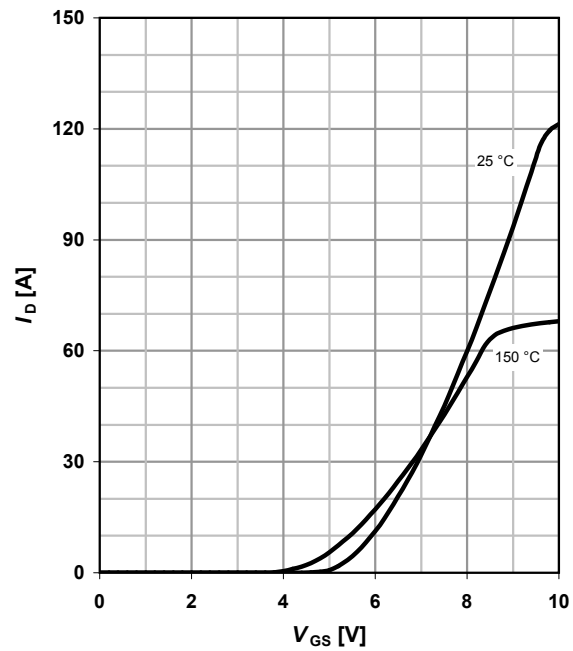

9 Typ. gate charge

$V_{GS}=f(Q_{gate}); I_D=34.1 \text{ A pulsed}$

parameter: V_{DD}

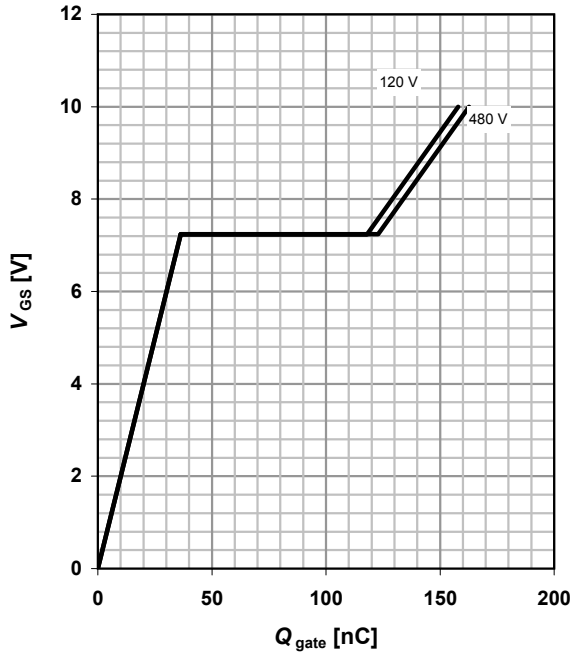

10 Forward characteristics of reverse diode

$I_F=f(V_{SD})$

parameter: T_j

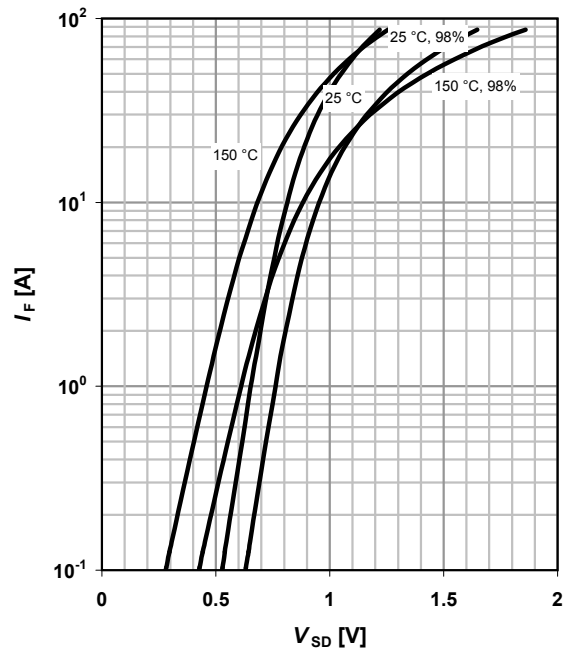

11 Avalanche SOA

$I_{AR}=f(t_{AR})$

parameter: $T_{j(start)}$

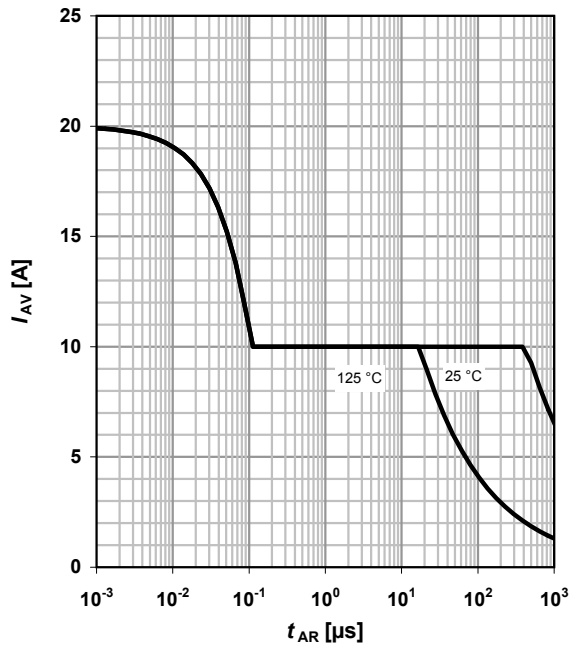

12 Avalanche energy

$E_{AS}=f(T_j); I_D=10 \text{ A}; V_{DD}=50 \text{ V}$

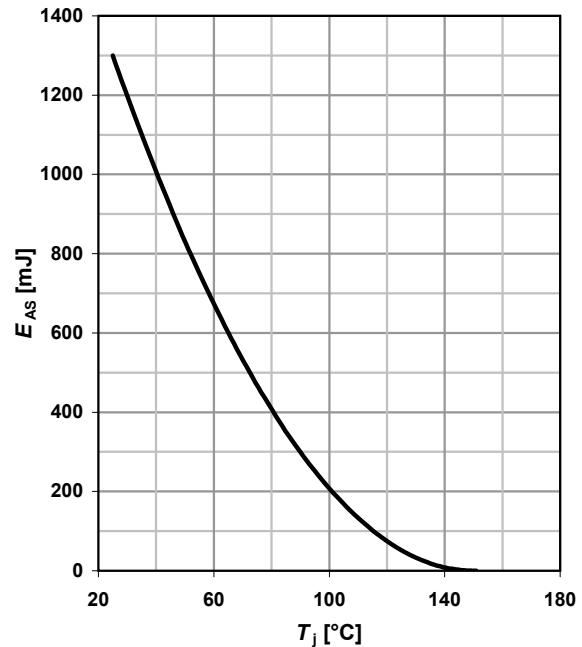

13 Drain-source breakdown voltage

$V_{BR(DSS)} = f(T_j); I_D = 10 \text{ mA}$

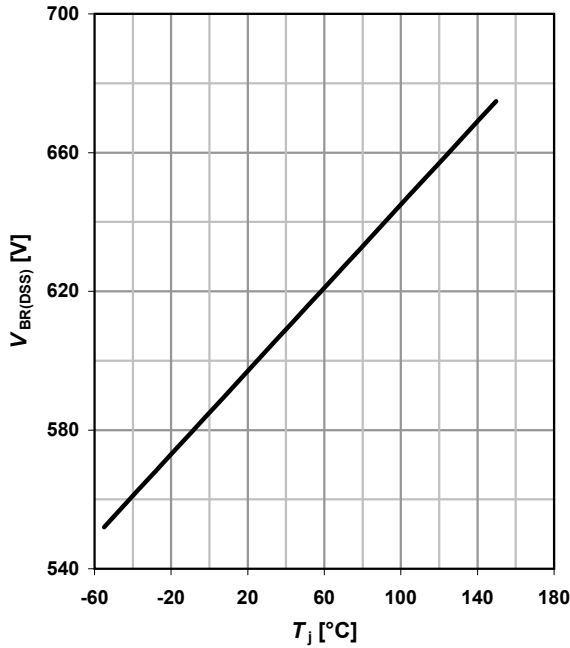

14 Typ. capacitances

$C = f(V_{DS}); V_{GS} = 0 \text{ V}; f = 1 \text{ MHz}$

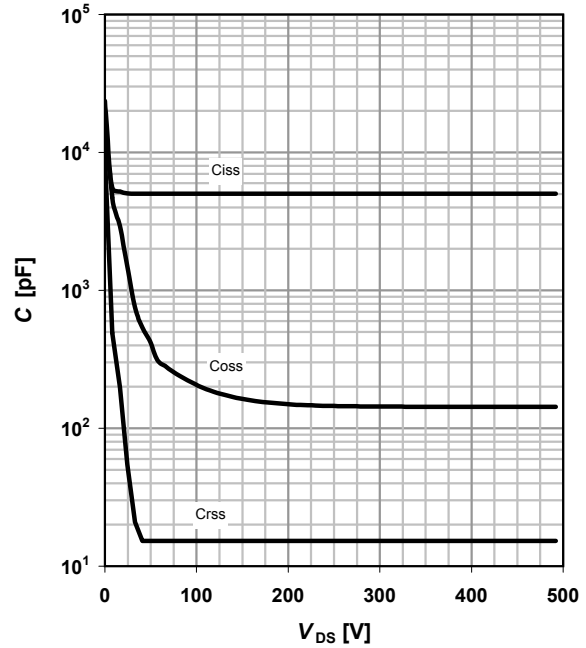

15 Typ. C_{oss} stored energy

$E_{oss} = f(V_{DS})$

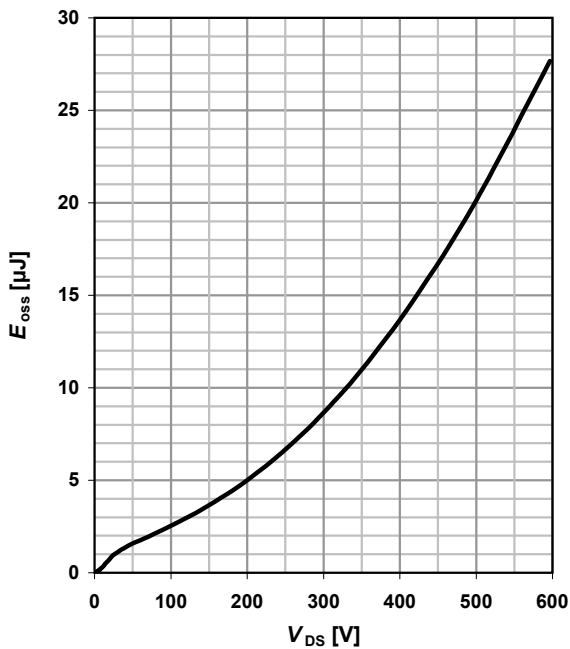

16 Typ. reverse recovery charge

$Q_{rr} = f(T_j); I_S = 34.1 \text{ A}; di/dt = 100 \text{ A}/\mu\text{s}$

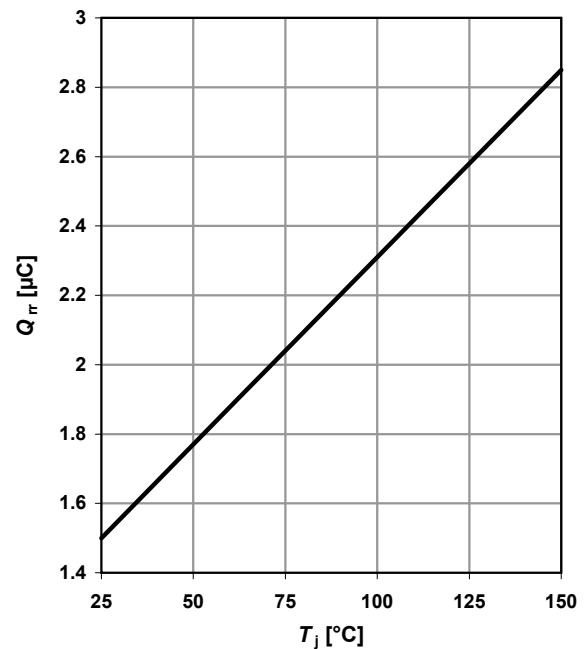

17 Typ. reverse recovery charge

$Q_{rr}=f(I_S); di/dt=100\text{ A}/\mu\text{s}$

parameter: T_j

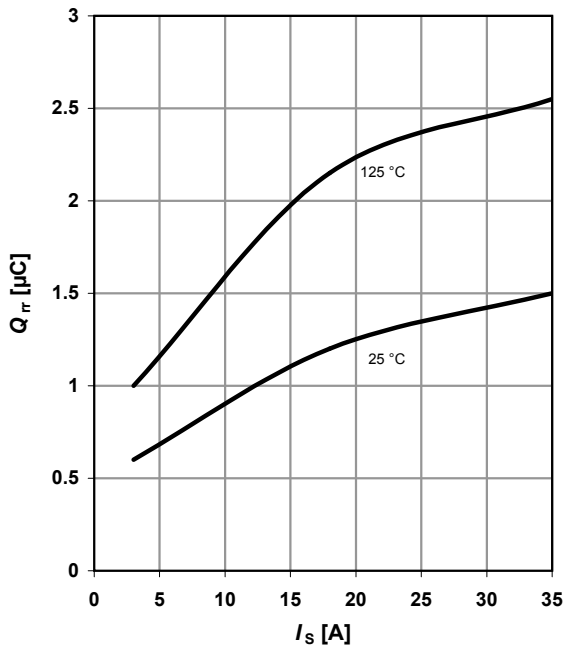

18 Typ. reverse recovery charge

$Q_{rr}=f(di/dt); I_S=34.1\text{ A}$

parameter: T_j

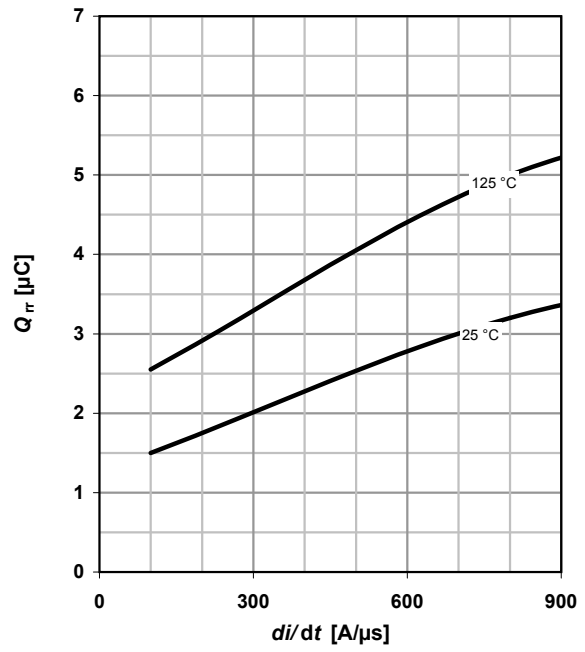

Definition of diode switching characteristics

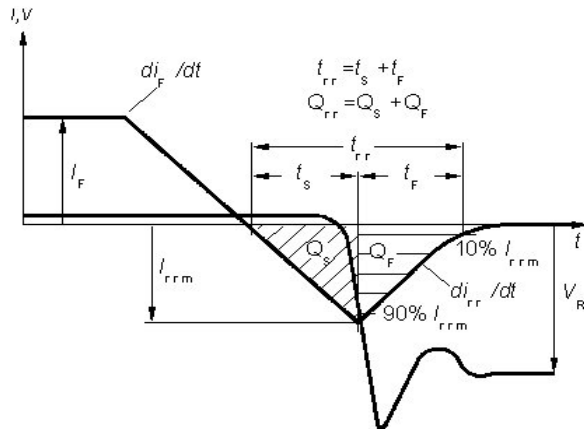

PG-TO-247-3-1

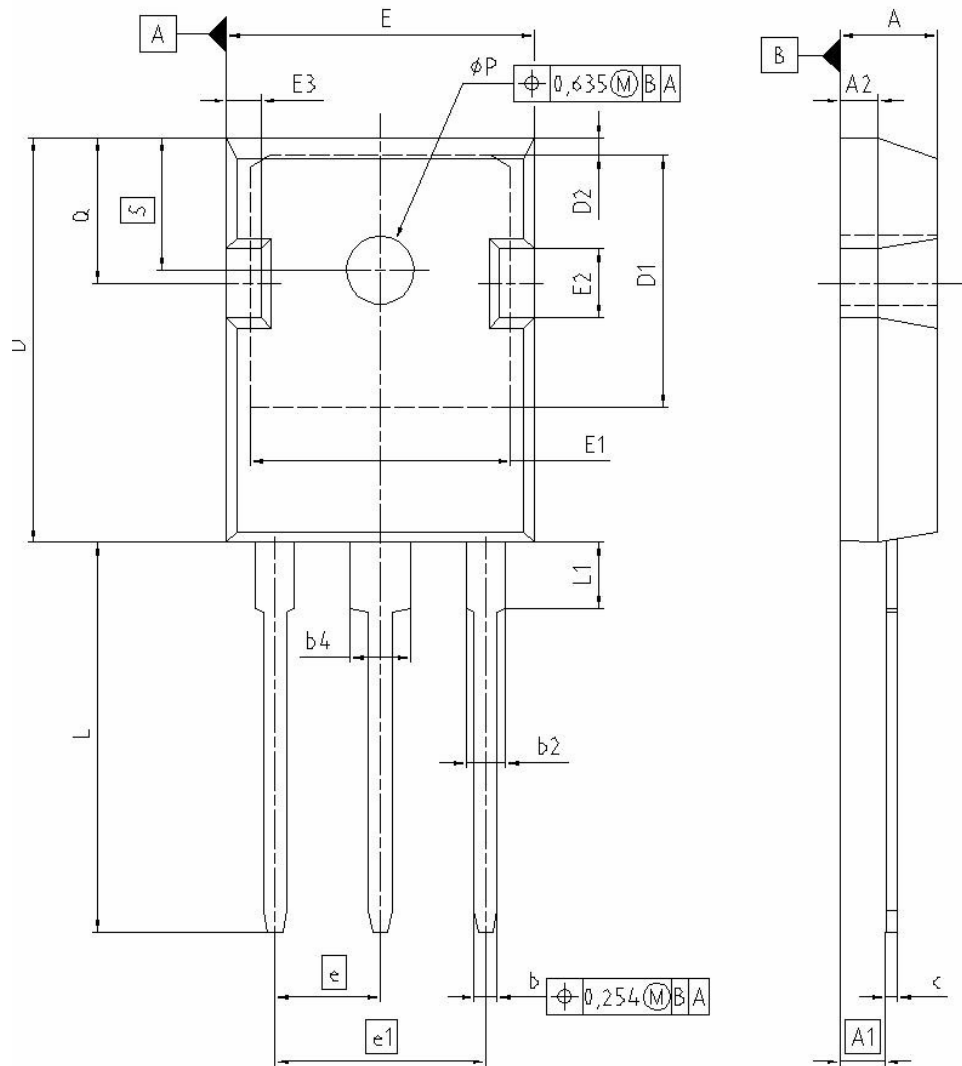

DIM	MILLIMETERS		INCHES	
	MIN	MAX	MIN	MAX
A	4.903	5.157	0.193	0.203
A1	2.273	2.527	0.092	0.096
A2	1.853	2.107	0.075	0.081
b	1.073	1.327	0.047	0.052
b2	1.903	2.386	0.075	0.094
b4	2.870	3.454	0.113	0.136
c	0.549	0.752	0.024	0.030
D	20.823	21.077	0.820	0.830
D1	17.323	17.831	0.682	0.702
D2	1.063	1.317	0.042	0.052
E	15.773	16.027	0.621	0.631
E1	13.893	14.147	0.547	0.557
E2	3.683	3.937	0.145	0.155
E3	1.683	1.937	0.066	0.076
e	5.450		0.215	
e1	10.900		0.430	
N	3		3	
L	20.053	20.307	0.789	0.799
L1	4.168	4.472	0.164	0.176
øP	3.559	3.661	0.140	0.144
Q	5.493	5.747	0.216	0.226
S	6.043	6.297	0.238	0.248

REFERENCE
JEDEC TO247-AD

SCALE

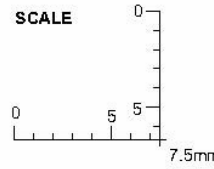

EUROPEAN PROJECTION

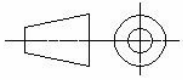

ISSUE DATE
28-06-2005

FILE
TO247_1

Published by
Infineon Technologies AG
Bereich Kommunikation
St.-Martin-Straße 53
D-81541 München
© Infineon Technologies AG 1999
All Rights Reserved.

Attention please!

The information herein is given to describe certain components and shall not be considered as warranted characteristics.

Terms of delivery and rights to technical change reserved.

We hereby disclaim any and all warranties, including but not limited to warranties of non-infringement, regarding circuits, descriptions and charts stated herein.

Infineon Technologies is an approved CECC manufacturer.

Information

For further information on technology, delivery terms and conditions and prices, please contact your nearest Infineon Technologies office in Germany or our Infineon Technologies representatives worldwide (see address list).

Warnings

Due to technical requirements, components may contain dangerous substances.

For information on the types in question, please contact your nearest Infineon Technologies office.

Infineon Technologies' components may only be used in life-support devices or systems with the expressed written approval of Infineon Technologies if a failure of such components can reasonably be expected to cause the failure of that life-support device or system, or to affect the safety or effectiveness of that device or system. Life support devices or systems are intended to be implanted in the human body, or to support and/or maintain and sustain and/or protect human life. If they fail, it is reasonable to assume that the health of the user or other persons may be endangered.