

ABSOLUTE MAXIMUM RATINGS

These are stress ratings only and functional operation of the device at these ratings or any other above those indicated in the operation sections of the specifications below is not implied. Exposure to absolute maximum rating conditions for extended periods of time may affect reliability.

Supply Voltage (V_{IN}).....7.0V	Operating Temperature Range.....-40°C to +85°C
Fault Flag Voltage (V_{FLG}).....7.0V	Storage Temperature Range.....-65°C to +150°C
Fault Flag Current (I_{FLG}).....50mA	Power Dissipation Per Package
Enable Input (V_{EN}).....-0.3V to 15V	8-pin NSOIC
	(derate 6.14mW/°C above +70°C).....500mW

ELECTRICAL CHARACTERISTICS

Unless otherwise noted, the following specifications apply for $V_{IN} = +5.0V$, $T_A = 25^\circ C$.

PARAMETER	MIN.	TYP.	MAX.	UNITS	CONDITIONS
Supply Current		0.75 75	5.0 100	μA	$V_{EN} = \text{Logic "0"}$ OUT = Open $V_{EN} = \text{Logic "1"}$ OUT = Open
Enable Input Voltage	2.4	1.7 2.0	0.8	V	$V_{EN} = \text{Logic "0"}$ $V_{EN} = \text{Logic "1"}$
Enable Input Current		0.01 0.01	1 1	μA	$V_{EN} = \text{Logic "0"}$ $V_{EN} = \text{Logic "1"}$
Enable Input Capacitance		1		pF	
Output Mosfet Resistance		70	100	m Ω	
Output Turn-On Delay		100		μs	$R_L = 10\Omega$ each output
Output Turn-On Rise Time		1000	4000	μs	$R_L = 10\Omega$ each output
Output Turn-Off Delay		0.8	20	μs	$R_L = 10\Omega$ each output
Output Turn-Off Fall Time		0.7	20	μs	$R_L = 10\Omega$ each output
Output Leakage Current			10	μA	
Current Limit Threshold	0.6	1.0	1.25	A	
Over-Temperature Shutdown Threshold		135 125		$^\circ C$	T_J increasing T_J decreasing
Error Flag Output Resistance		10 15	25 40	Ω	$V_{IN} = 5V, I_L = 10mA$ $V_{IN} = 3.3V, I_L = 10mA$
Error Flag Off Current		0.01	1	μA	$V_{FLAG} = 5V$
UVLO Threshold		2.6 2.4		V	V_{IN} increasing V_{IN} decreasing

PIN DESCRIPTION

Pin Number	Pin Name	Description
1	EN	Enable Input Active High for SP2525A-1 and Active Low for SP2525A-2.
2	FLG	An active-low and open-drained fault flag output for power switch. It can indicate current limit if CTL is active. In normal mode operation, it also can indicate thermal shutdown or undervoltage.
3	GND	Chip power ground.
4	NC	Not internally connected.
5, 7	IN	Power supply input.
6, 8	OUT	MOSFET switch output.

TEST CIRCUIT

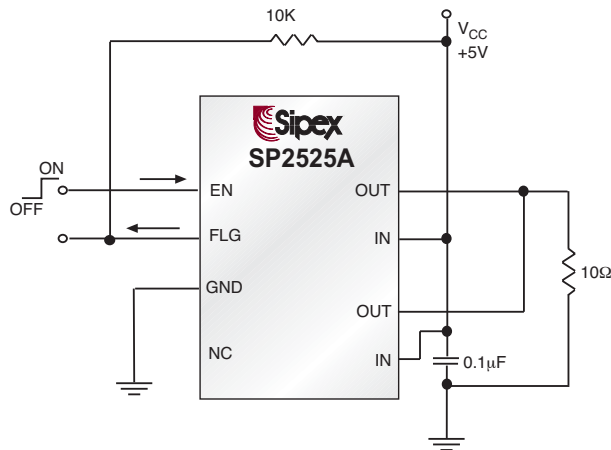

BLOCK DIAGRAM

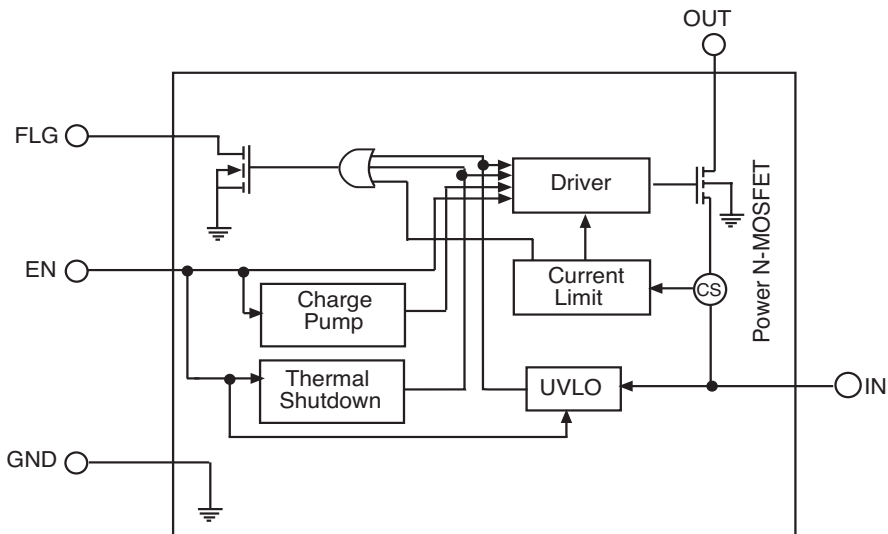

Error Flag

The Error Flag is an open-drained output of an N-channel MOSFET, the FLG output is pulled low to signal the following fault conditions: input undervoltage, output current limit, and thermal shutdown.

Current Limit

The current limit threshold is preset internally. It protects the output MOSFET switches from damage resulting from undesirable short circuit conditions or excess inrush current, which is often encountered during hot plug-in. The low limit of the current limit threshold of the SP2525A allows a minimum current of 0.5A through the MOSFET switches. A current limit condition will signal the Error Flag.

Thermal Shutdown

When the temperature of the SP2525A exceeds 135°C for any reasons, the thermal shutdown function turns off the MOSFET switch and signals the Error Flag. A hysteresis of 10°C prevents the MOSFETs from turning back on until the chip temperature drops below 125°C.

Supply Filtering

A 0.1 μ F to 1 μ F bypass capacitor from IN to GND, located near the device, is strongly recommended to control supply transients. Without a bypass capacitor, an output short may cause ringing on the input (from supply lead inductance) which can damage internal control circuitry.

Transient Requirements

USB supports dynamic attachment (hot plug-in) of peripherals. A current surge is caused by the input capacitance of a downstream device. Ferrite beads are recommended in series with all power and ground connector pins. Ferrite beads reduce EMI and limit the inrush current during hot-attachment by filtering high-frequency signals.

Short Circuit Transient

Bulk capacitance provides the short-term transient current needed during a hot-attachment event. A 33 μ F/16V tantalum or a 100 μ F/10V electrolytic capacitor mounted close to the downstream connector at each port should provide sufficient transient drop protection.

Printed Circuit Layout

The Power circuitry of USB printed circuit boards requires a customized layout to maximize thermal dissipation and to minimize voltage drop and EMI.

Input and Output

The independent solid state switch connects the IN pin to the OUT pin when enabled by a logic signal at EN. The IN pin is the power supply connection to the internal circuitry and the drain of the output MOSFET. The OUT pin is the source for the MOSFET. Typically, the current in USB application will flow through the switch from IN to OUT towards the load. If V_{OUT} is greater than V_{IN} when a switch is enabled, the current will flow from OUT to the IN pin because the MOSFET channels are bidirectional when switched on. The output source is allowed to be externally forced to a higher voltage than its input without causing unwanted current flow when the output is disabled.

TYPICAL PERFORMANCE CHARACTERISTICS

$V_{IN} = +5.0V$, $T_{AMB} = +25^{\circ}C$ unless otherwise noted.

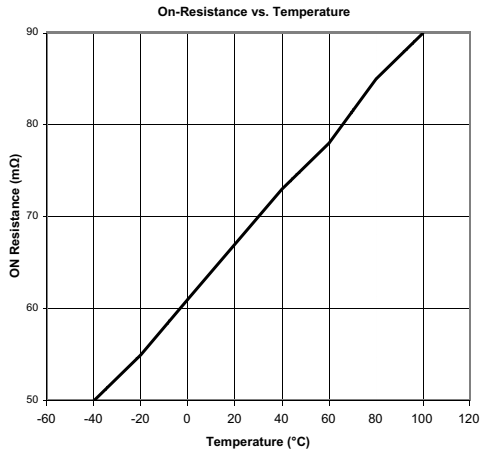
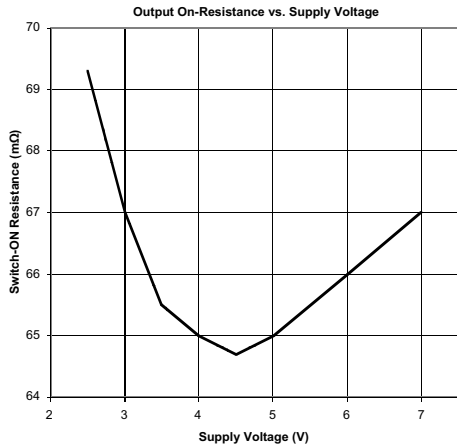

Output On-Resistance vs. Supply Voltage

Output On-Resistance vs. Temperature

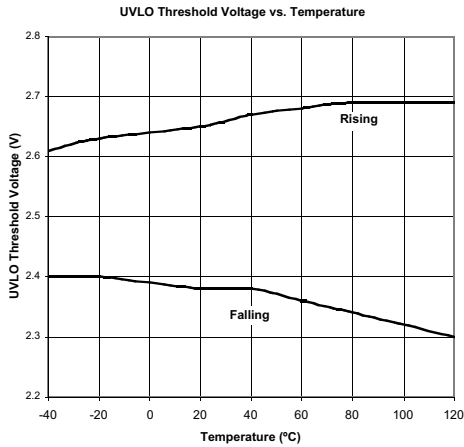

UVLO Threshold Voltage vs. Temperature

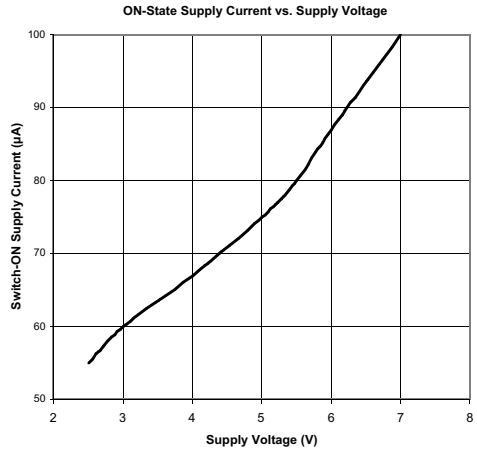

On-state Supply Current vs. Supply Voltage

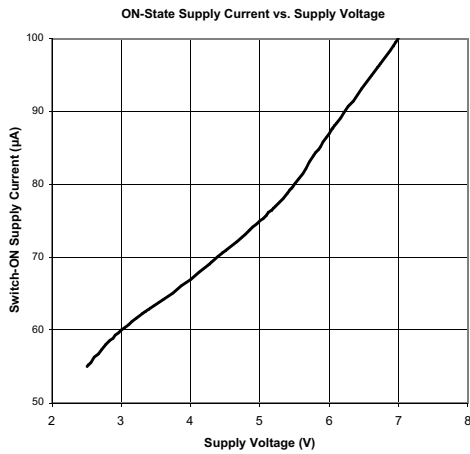

On-state Supply Current vs. Temperature

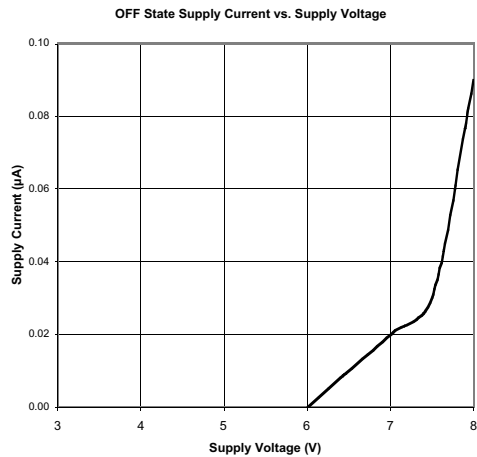

Off-state Supply Current vs. Supply Voltage

TYPICAL PERFORMANCE CHARACTERISTICS

$V_{IN} = +5.0V$, $T_{AMB} = +25^{\circ}C$ unless otherwise noted.

CTL Threshold Voltage vs. Supply Voltage

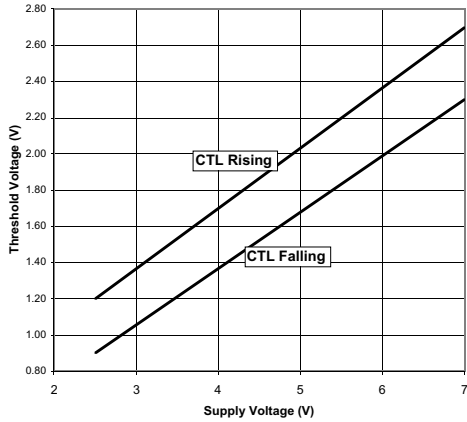

Control Threshold vs. Supply Voltage

Current Limit Threshold vs. Temperature

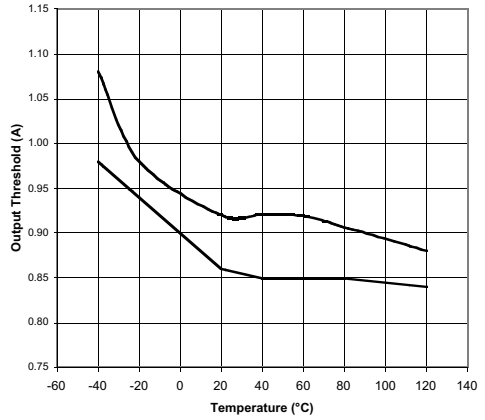

Current Limit Threshold vs. Temperature

Output Rise Time vs. Temperature

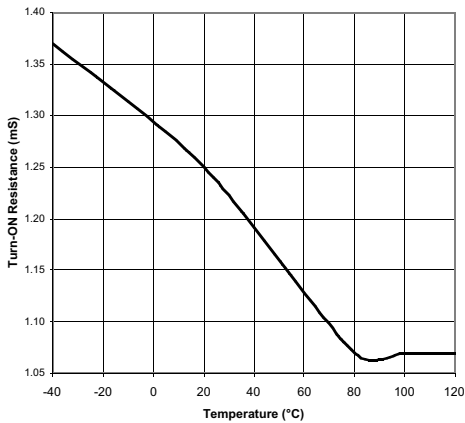

Output Rise Time vs. Temperature

Output Fall Time vs. Temperature

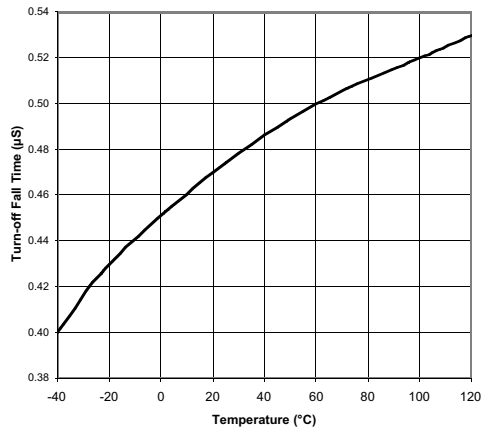

Output Fall Time vs. Temperature

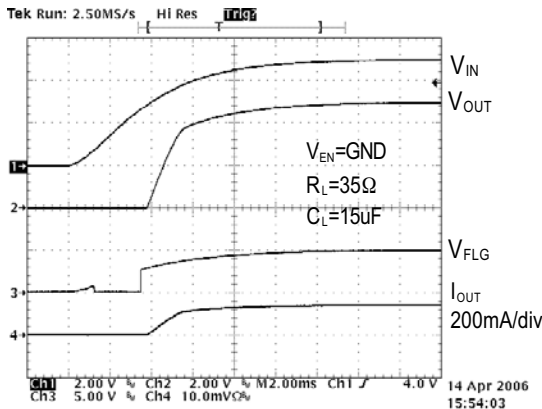

Input Voltage Response

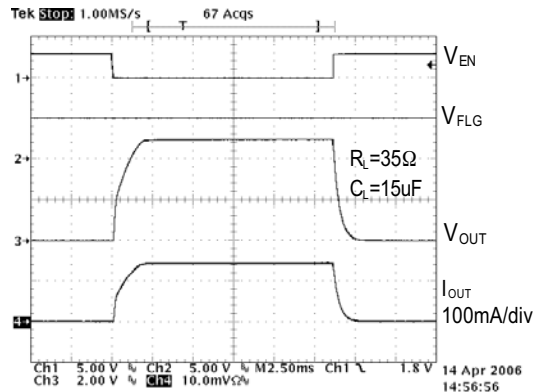

Turn-On, Turn-Off Characteristics

TYPICAL PERFORMANCE CHARACTERISTICS

$V_{IN} = +5.0V$, $T_{AMB} = +25^{\circ}C$ unless otherwise noted.

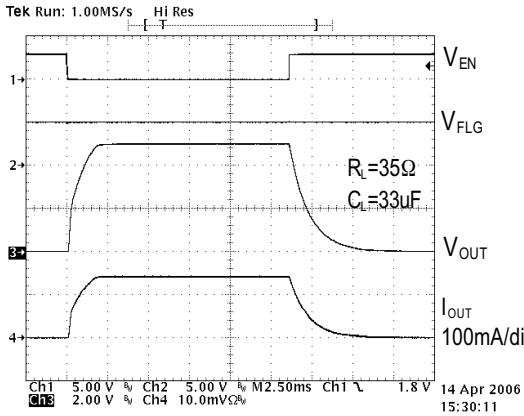

Turn-On, Turn-Off Characteristics

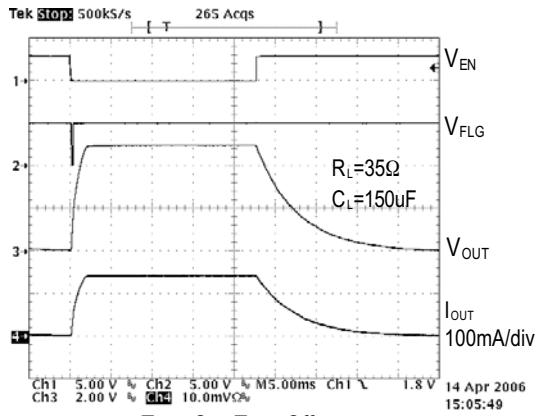

Turn-On, Turn-Off Characteristics

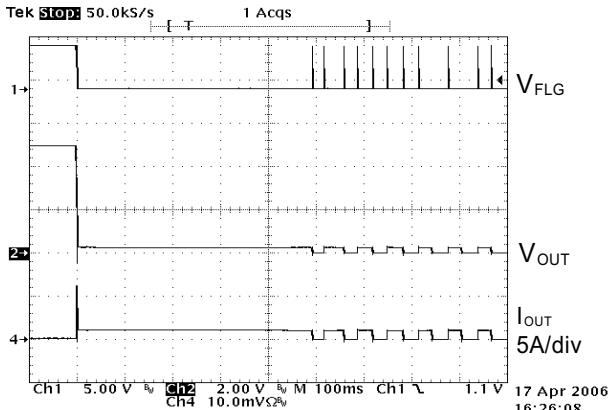

Short Circuit Response (Short Applied to Output)

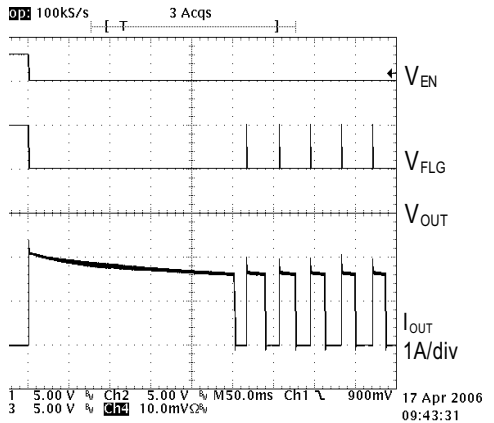

Short Circuit Response (Enable to Short Circuit)

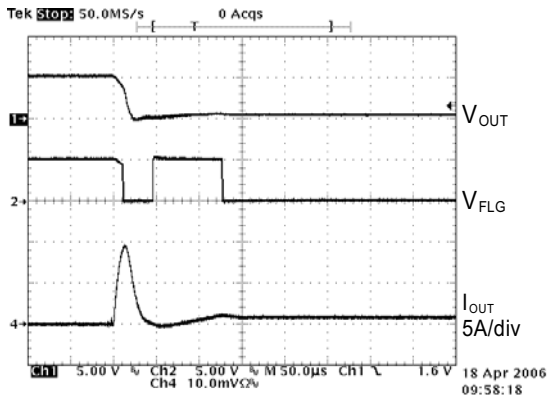

Short Circuit Transient Response (Short Applied to Output)

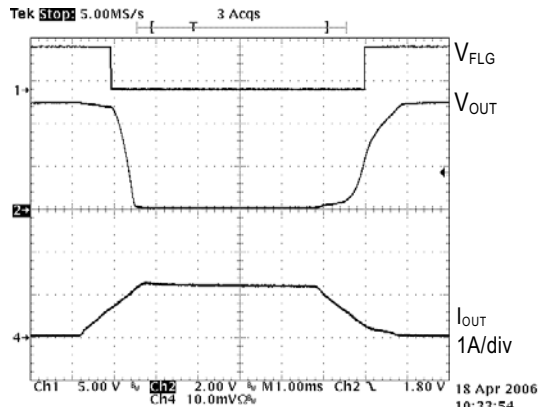

Current Limit Response (Ramped Load)

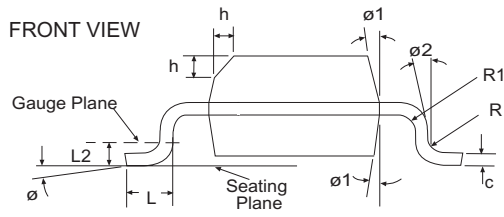
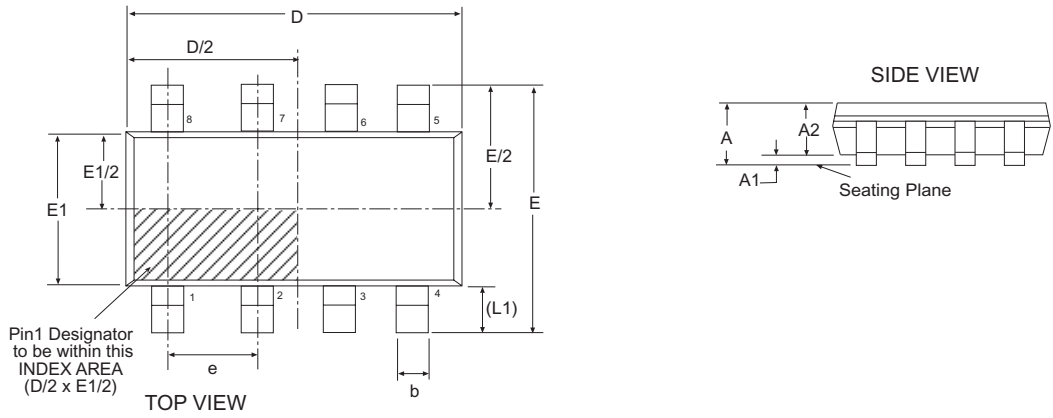

8 Pin NSOIC		JEDEC MS-012		Variation AA		
SYMBOL	Dimensions in Millimeters: Controlling Dimension			Dimensions in Inches Conversion Factor: 1 Inch = 25.40 mm		
	MIN	NOM	MAX	MIN	NOM	MAX
A	1.35	-	1.75	0.053	-	0.069
A1	0.10	-	0.25	0.004	-	0.010
A2	1.25	-	1.65	0.049	-	0.065
b	0.31	-	0.51	0.012	-	0.020
c	0.17	-	0.25	0.007	-	0.010
E	6.00 BSC			0.236 BSC		
E1	3.90 BSC			0.154 BSC		
e	1.27 BSC			0.050 BSC		
h	0.25	-	0.50	0.010	-	0.020
L	0.40	-	1.27	0.016	-	0.050
L1	1.04 REF			0.041 REF		
L2	0.25 BSC			0.010 BSC		
R	0.07	-	-	0.003	-	-
R1	0.07	-	-	0.003	-	-
ø	0°	-	8°	0°	-	8°
ø1	5°	-	15°	5°	-	15°
ø2	0°	-	-	0°	-	-
D	4.90 BSC			0.193 BSC		
SIPEX Pkg Signoff Date/Rev:				JL Aug16-05 / Rev A		

ORDERING INFORMATION

Part Number	Temperature Range	Package Types
SP2525A-1EN	-40°C to +85°C	8-pin NSOIC
SP2525A-1EN/TR	-40°C to +85°C	8-pin NSOIC
SP2525A-2EN	-40°C to +85°C	8-pin NSOIC
SP2525A-2EN/TR	-40°C to +85°C	8-pin NSOIC

Available in lead free packaging. To order add “-L” suffix to part number.

Example: SP2525A-1EN/TR = standard; SP2525A-1EN-L/TR = lead free

/TR = Tape and Reel

Pack quantity is 2,500 for 8 pin NSOIC.



Solved by Sipex.

Sipex Corporation

Headquarters and Sales Office

233 South Hillview Drive
Milpitas, CA 95035
TEL: (408) 934-7500
FAX: (408) 935-7600

Sipex Corporation reserves the right to make changes to any products described herein. Sipex does not assume any liability arising out of the application or use of any product or circuit described herein; neither does it convey any license under its patent rights nor the rights of others.