

# DATA SHEET

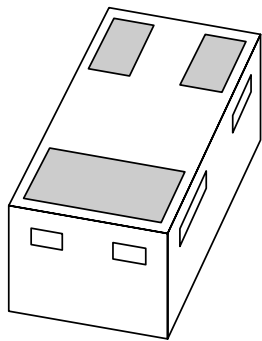

## **PESDxL2UM series**

Low capacitance double ESD  
protection diode

Product specification

2003 Aug 05

# Low capacitance double ESD protection diode

# PESDxL2UM series

### FEATURES

- Uni-directional ESD protection of two lines or bi-directional ESD protection of one line
- Reverse standoff voltage 3.3 and 5 V
- Low diode capacitance
- Ultra low leakage current
- Leadless ultra small SOT883 surface mount package (1 × 0.6 × 0.5 mm)
- Board space 1.17 mm<sup>2</sup> (approx. 10% of SOT23)
- ESD protection >15 kV
- IEC 61000-4-2; level 4 (ESD); 15 kV (air) or 8 kV (contact).

### APPLICATIONS

- Cellular handsets and accessories
- Portable electronics
- Computers and peripherals
- Communication systems
- Audio and video equipment.

### MARKING

TYPE NUMBER	MARKING CODE
PESD3V3L2UM	F2
PESD5V0L2UM	F1

### DESCRIPTION

Low capacitance ESD protection diode in a three pad SOT883 leadless ultra small plastic package designed to protect up to two transmission or data lines from ElectroStatic Discharge (ESD) damage.

### PINNING

PIN	DESCRIPTION
1	cathode 1
2	cathode 2
3	common anode

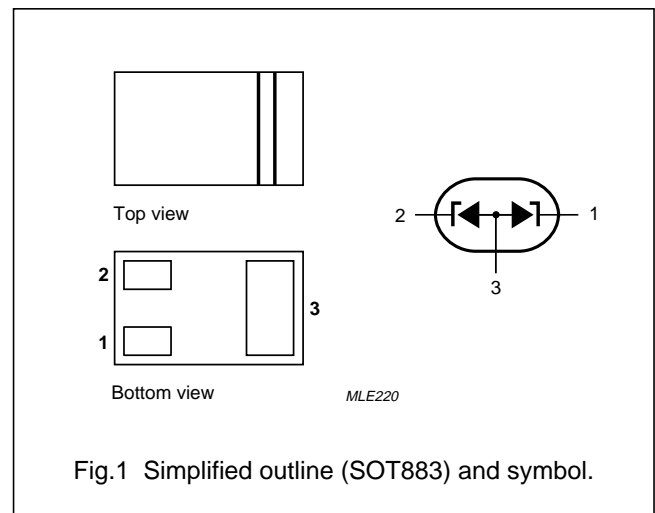

## Low capacitance double ESD protection diode

## PESDxL2UM series

**LIMITING VALUES**

In accordance with the Absolute Maximum Rating System (IEC 60134).

SYMBOL	PARAMETER	CONDITIONS	MIN.	MAX.	UNIT
<b>Per diode</b>					
I <sub>pp</sub>	peak pulse current	8/20 μs pulse; notes 1, 2 and 3	–	3	A
	PESD3V3L2UM PESD5V0L2UM			2.5	A
P <sub>pp</sub>	peak pulse power	8/20 μs pulse; notes 1, 2 and 3	–	30	W
I <sub>FSM</sub>	non-repetitive peak forward current	t <sub>p</sub> = 1 ms; square pulse	–	3.5	A
I <sub>ZSM</sub>	non-repetitive peak reverse current	t <sub>p</sub> = 1 ms; square pulse	–	0.9	A
	PESD3V3L2UM PESD5V0L2UM			0.8	A
P <sub>tot</sub>	total power dissipation	T <sub>amb</sub> = 25 °C; note 4	–	250	mW
P <sub>ZSM</sub>	non-repetitive peak reverse power dissipation	t <sub>p</sub> = 1 ms; square pulse; see Fig.4	–	6	W
T <sub>stg</sub>	storage temperature		–65	+150	°C
T <sub>j</sub>	junction temperature		–	150	°C
ESD	electrostatic discharge	IEC 61000-4-2 (contact discharge)	15	–	kV
		HBM MIL-Std 883	10	–	kV

**Notes**

1. Non-repetitive current pulse 8/20 μs exponential decay waveform; see Fig.5.
2. Pins 1 and 3 or 2 and 3.
3. Pins 1 and 2.
4. Device mounted on standard printed-circuit board.

**ESD standards compliance**

IEC 61000-4-2, level 4 (ESD)	>15 kV (air); >8 kV (contact)
HBM MIL-Std 883, class 3	>4 kV

**THERMAL CHARACTERISTICS**

SYMBOL	PARAMETER	CONDITIONS	VALUE	UNIT
R <sub>th j-a</sub>	thermal resistance from junction to ambient	all diodes loaded; note 1	500	K/W
		one diode loaded; note 2	290	K/W

**Notes**

1. Refer to SOT883 standard mounting conditions (footprint), FR4 with 60 μm copper strip line.
2. FR4 single-sided copper 1 cm<sup>2</sup>.

## Low capacitance double ESD protection diode

## PESDxL2UM series

**ELECTRICAL CHARACTERISTICS**T<sub>j</sub> = 25 °C unless otherwise specified.

SYMBOL	PARAMETER	CONDITIONS	MIN.	TYP.	MAX.	UNIT
<b>Per diode</b>						
V <sub>F</sub>	forward voltage	I <sub>F</sub> = 200 mA	–	1	1.2	V
V <sub>RWM</sub>	reverse stand-off voltage					
	PESD3V3L2UM		–	–	3.3	V
	PESD5V0L2UM		–	–	5	V
I <sub>RM</sub>	reverse leakage current					
	PESD3V3L2UM	V <sub>R</sub> = 3.3 V	–	75	300	nA
	PESD5V0L2UM	V <sub>R</sub> = 5 V	–	5	25	nA
V <sub>(CL)R</sub>	clamping voltage	8/20 μs pulse				
	PESD3V3L2UM	I <sub>pp</sub> = 1 A; notes 1 and 2	–	–	8	V
		I <sub>pp</sub> = 3 A; notes 1 and 2	–	–	12	V
		I <sub>pp</sub> = 1 A; notes 1 and 3	–	–	9	V
		I <sub>pp</sub> = 3 A; notes 1 and 3	–	–	13	V
	PESD5V0L2UM	I <sub>pp</sub> = 1 A; notes 1 and 2	–	–	10	V
		I <sub>pp</sub> = 2.5 A; notes 1 and 2	–	–	13	V
		I <sub>pp</sub> = 1 A; notes 1 and 3	–	–	11	V
I <sub>pp</sub> = 2.5 A; notes 1 and 3		–	–	15	V	
V <sub>BR</sub>	breakdown voltage	I <sub>Z</sub> = 1 mA				
	PESD3V3L2UM		5.32	5.6	5.88	V
	PESD5V0L2UM		6.46	6.8	7.14	V
S <sub>Z</sub>	temperature coefficient	I <sub>Z</sub> = 1 mA				
	PESD3V3L2UM		–	1.3	–	mV/K
	PESD5V0L2UM		–	2.9	–	mV/K
r <sub>diff</sub>	differential resistance	I <sub>R</sub> = 1 mA				
	PESD3V3L2UM		–	–	200	Ω
	PESD5V0L2UM		–	–	100	Ω
C <sub>d</sub>	diode capacitance					
	PESD3V3L2UM	f = 1 MHz; V <sub>R</sub> = 0	–	22	28	pF
		f = 1 MHz; V <sub>R</sub> = 5	–	12	17	pF
	PESD5V0L2UM	f = 1 MHz; V <sub>R</sub> = 0	–	16	19	pF
f = 1 MHz; V <sub>R</sub> = 5		–	8	11	pF	

**Notes**

1. Non-repetitive current pulse 8/20 μs exponential decay waveform; see Fig.5.
2. Pins 1 and 3 or 2 and 3.
3. Pins 1 and 2.

Low capacitance double ESD protection diode

PESDxL2UM series

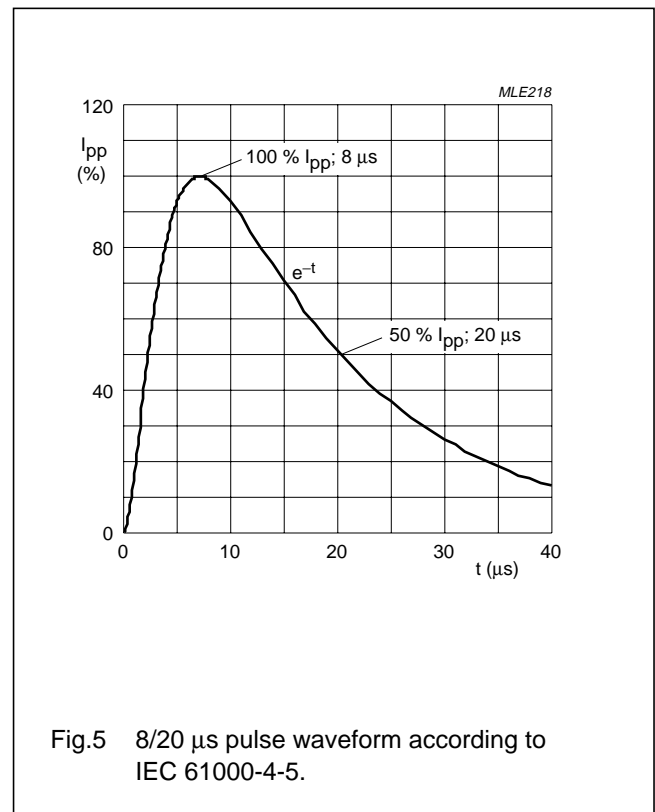
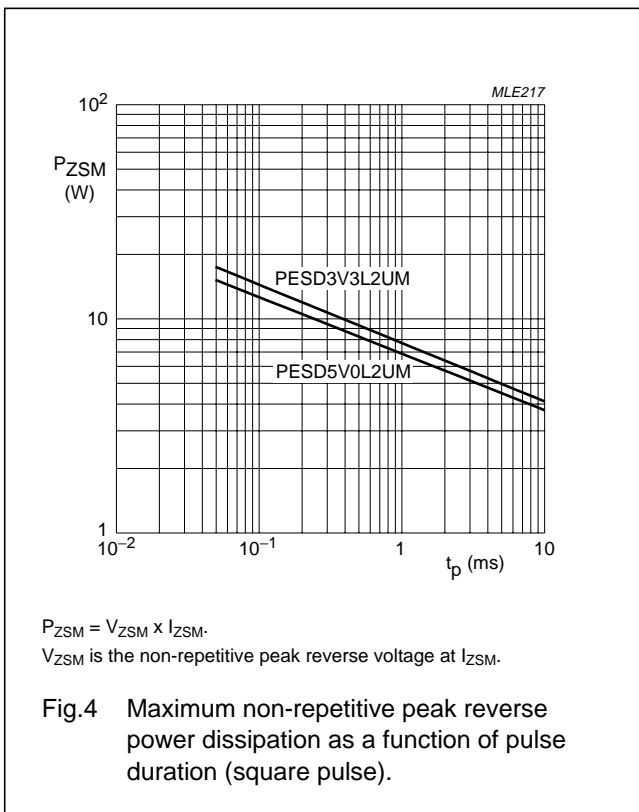
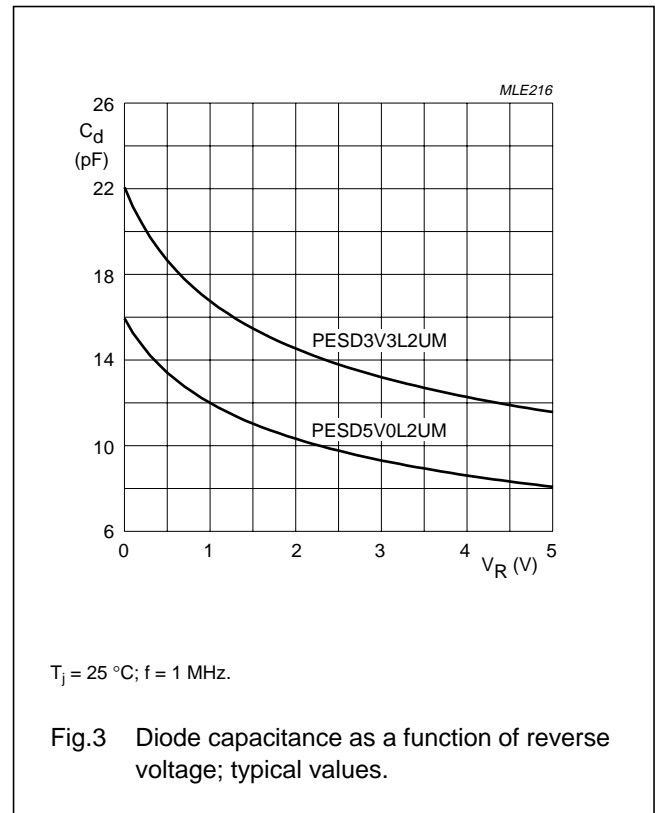
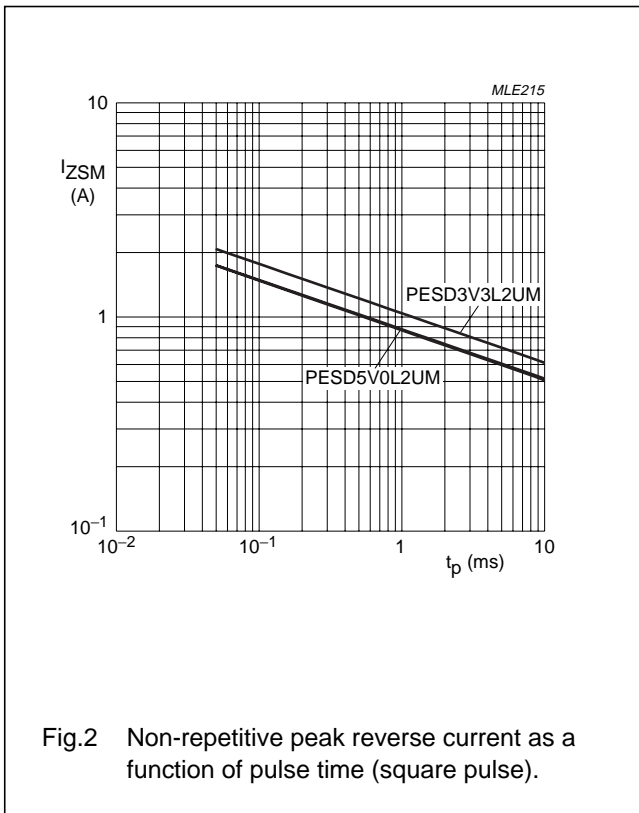

Low capacitance double ESD protection diode

PESDxL2UM series

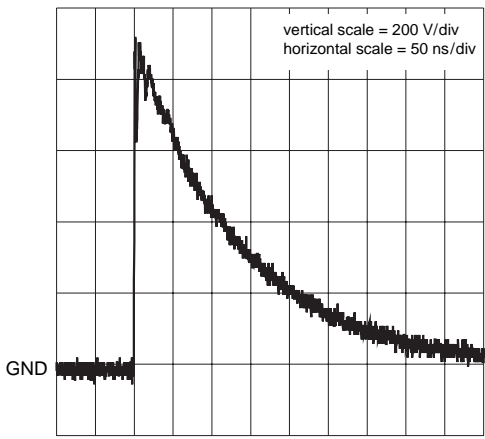
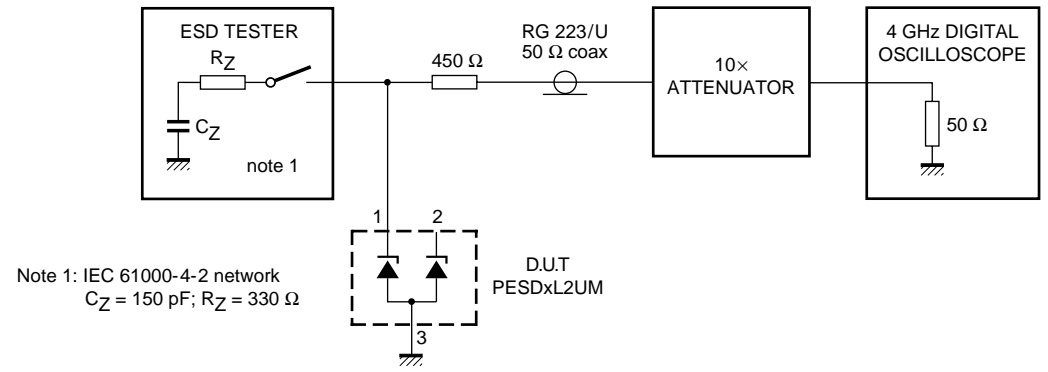

unclamped +1 kV ESD voltage waveform  
(IEC 61000-4-2 network)

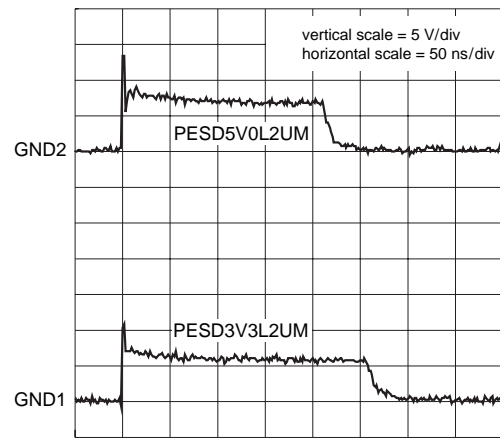

clamped +1 kV ESD voltage waveform  
(IEC 61000-4-2 network)

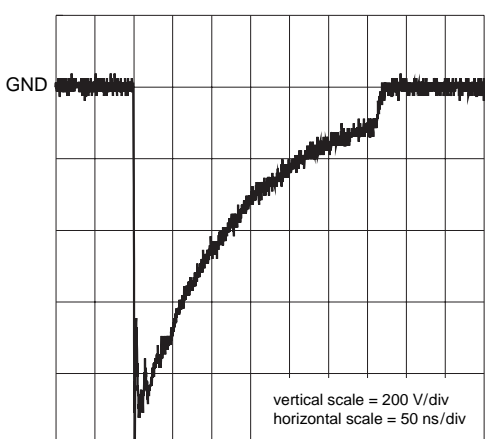

unclamped -1 kV ESD voltage waveform  
(IEC 61000-4-2 network)

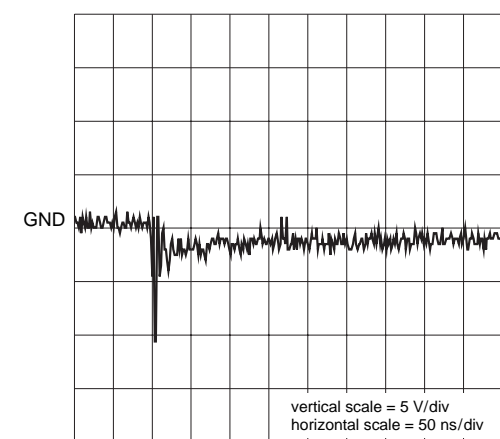

clamped -1 kV ESD voltage waveform  
(IEC 61000-4-2 network)

MLE219

Fig.6 ESD clamping test set-up and waveforms.

Low capacitance double ESD protection diode

PESDxL2UM series

PACKAGE OUTLINE

Leadless ultra small plastic package; 3 solder lands; body 1.0 x 0.6 x 0.5 mm

SOT883

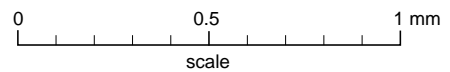
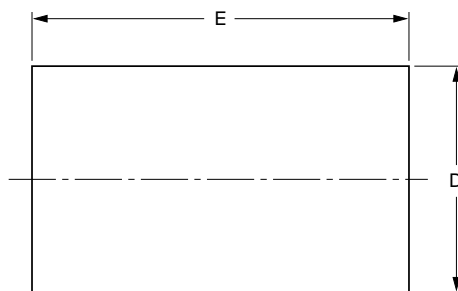
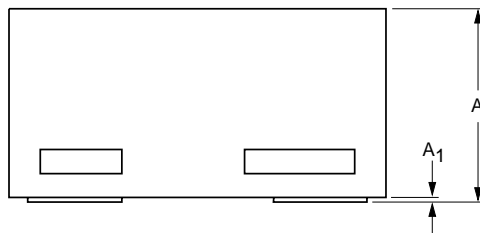
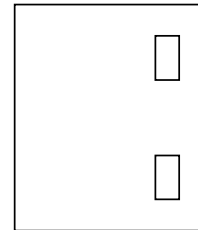
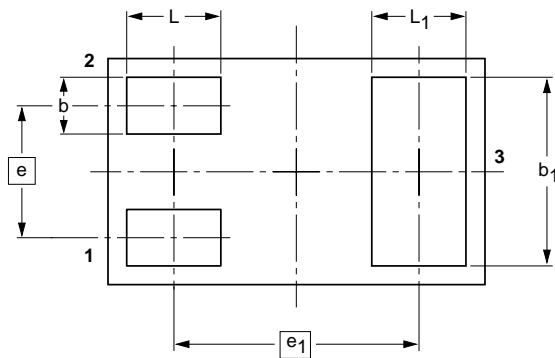

DIMENSIONS (mm are the original dimensions)

UNIT	A <sup>(1)</sup>	A <sub>1</sub> max.	b	b <sub>1</sub>	D	E	e	e <sub>1</sub>	L	L <sub>1</sub>
mm	0.50 0.46	0.03	0.20 0.12	0.55 0.47	0.62 0.55	1.02 0.95	0.35	0.65	0.30 0.22	0.30 0.22

Note

1. Including plating thickness

OUTLINE VERSION	REFERENCES				EUROPEAN PROJECTION	ISSUE DATE
	IEC	JEDEC	JEITA			
SOT883			SC-101			03-02-05 03-04-03

## Low capacitance double ESD protection diode

## PESDxL2UM series

## DATA SHEET STATUS

LEVEL	DATA SHEET STATUS <sup>(1)</sup>	PRODUCT STATUS <sup>(2)(3)</sup>	DEFINITION
I	Objective data	Development	This data sheet contains data from the objective specification for product development. Philips Semiconductors reserves the right to change the specification in any manner without notice.
II	Preliminary data	Qualification	This data sheet contains data from the preliminary specification. Supplementary data will be published at a later date. Philips Semiconductors reserves the right to change the specification without notice, in order to improve the design and supply the best possible product.
III	Product data	Production	This data sheet contains data from the product specification. Philips Semiconductors reserves the right to make changes at any time in order to improve the design, manufacturing and supply. Relevant changes will be communicated via a Customer Product/Process Change Notification (CPCN).

## Notes

1. Please consult the most recently issued data sheet before initiating or completing a design.
2. The product status of the device(s) described in this data sheet may have changed since this data sheet was published. The latest information is available on the Internet at URL <http://www.semiconductors.philips.com>.
3. For data sheets describing multiple type numbers, the highest-level product status determines the data sheet status.

## DEFINITIONS

**Short-form specification** — The data in a short-form specification is extracted from a full data sheet with the same type number and title. For detailed information see the relevant data sheet or data handbook.

**Limiting values definition** — Limiting values given are in accordance with the Absolute Maximum Rating System (IEC 60134). Stress above one or more of the limiting values may cause permanent damage to the device. These are stress ratings only and operation of the device at these or at any other conditions above those given in the Characteristics sections of the specification is not implied. Exposure to limiting values for extended periods may affect device reliability.

**Application information** — Applications that are described herein for any of these products are for illustrative purposes only. Philips Semiconductors make no representation or warranty that such applications will be suitable for the specified use without further testing or modification.

## DISCLAIMERS

**Life support applications** — These products are not designed for use in life support appliances, devices, or systems where malfunction of these products can reasonably be expected to result in personal injury. Philips Semiconductors customers using or selling these products for use in such applications do so at their own risk and agree to fully indemnify Philips Semiconductors for any damages resulting from such application.

**Right to make changes** — Philips Semiconductors reserves the right to make changes in the products - including circuits, standard cells, and/or software - described or contained herein in order to improve design and/or performance. When the product is in full production (status 'Production'), relevant changes will be communicated via a Customer Product/Process Change Notification (CPCN). Philips Semiconductors assumes no responsibility or liability for the use of any of these products, conveys no licence or title under any patent, copyright, or mask work right to these products, and makes no representations or warranties that these products are free from patent, copyright, or mask work right infringement, unless otherwise specified.



# ***Philips Semiconductors – a worldwide company***

## **Contact information**

For additional information please visit <http://www.semiconductors.philips.com>. Fax: +31 40 27 24825

For sales offices addresses send e-mail to: [sales.addresses@www.semiconductors.philips.com](mailto:sales.addresses@www.semiconductors.philips.com).

© Koninklijke Philips Electronics N.V. 2003

SCA75

All rights are reserved. Reproduction in whole or in part is prohibited without the prior written consent of the copyright owner.

The information presented in this document does not form part of any quotation or contract, is believed to be accurate and reliable and may be changed without notice. No liability will be accepted by the publisher for any consequence of its use. Publication thereof does not convey nor imply any license under patent- or other industrial or intellectual property rights.

Printed in The Netherlands

613514/01/pp9

Date of release: 2003 Aug 05

Document order number: 9397 750 11644

*Let's make things better.*

**Philips  
Semiconductors**



**PHILIPS**