

Dual 12MHz Rail-to-Rail Input-Output Buffer

The EL5221 is a dual, low power, high voltage rail-to-rail input-output buffer. Operating on supplies ranging from 5V to 15V, while consuming only 500µA per channel, the EL5221 has a bandwidth of 12MHz (-3dB). The EL5221 also provides rail-to-rail input and output ability, giving the maximum dynamic range at any supply voltage.

The EL5221 also features fast slewing and settling times, as well as a high output drive capability of 30mA (sink and source). These features make the EL5221 ideal for use as voltage reference buffers in Thin Film Transistor Liquid Crystal Displays (TFT-LCD). Other applications include battery power, portable devices, and anywhere low power consumption is important.

The EL5221 is available in space-saving 6-pin SOT-23 and 8-pin MSOP packages and operates over a temperature range of -40°C to +85°C.

Ordering Information

PART NUMBER	PACKAGE	TAPE & REEL	PKG. DWG. #
EL5221CW-T7	6-Pin SOT-23*	7" (3K pcs)	MDP0038
EL5221CW-T7A	6-Pin SOT-23*	7" (250 pcs)	MDP0038
EL5221CWZ-T7 (See Note)	6-Pin SOT-23* (Pb-free)	7" (3K pcs)	MDP0038
EL5221CWZ-T7A (See Note)	6-Pin SOT-23* (Pb-free)	7" (250 pcs)	MDP0038
EL5221CY	8-Pin MSOP	-	MDP0043
EL5221CY-T7	8-Pin MSOP	7"	MDP0043
EL5221CY-T13	8-Pin MSOP	13"	MDP0043
EL5221CYZ (See Note)	8-Pin MSOP (Pb-free)	-	MDP0043
EL5221CYZ-T7 (See Note)	8-Pin MSOP (Pb-free)	7"	MDP0043
EL5221CYZ-T13 (See Note)	8-Pin MSOP (Pb-free)	13"	MDP0043

*EL5221CW symbol is .Mxxx where xxx represents date code.

NOTE: Intersil Pb-free plus anneal products employ special Pb-free material sets; molding compounds/die attach materials and 100% matte tin plate termination finish, which are RoHS compliant and compatible with both SnPb and Pb-free soldering operations. Intersil Pb-free products are MSL classified at Pb-free peak reflow temperatures that meet or exceed the Pb-free requirements of IPC/JEDEC J STD-020.

Features

- 12MHz -3dB bandwidth
- Unity gain buffer
- Supply voltage = 4.5V to 16.5V
- Low supply current (per buffer) = 500µA
- High slew rate = 10V/µs
- Rail-to-rail operation
- Pb-Free plus anneal available (RoHS compliant)

Applications

- TFT-LCD drive circuits
- Electronics notebooks
- Electronics games
- Personal communication devices
- Personal Digital Assistants (PDA)
- Portable instrumentation
- Wireless LANs
- Office automation
- Active filters
- ADC/DAC buffer

Pinouts

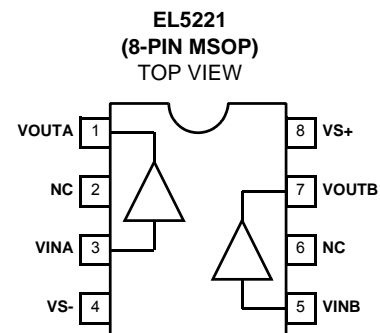
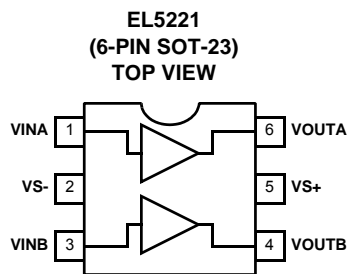

Absolute Maximum Ratings ($T_A = 25^\circ\text{C}$)

Supply Voltage between V_{S+} and V_{S-}	+18V	Storage Temperature.....	-65°C to +150°C
Input Voltage.....	$V_{S-} - 0.5\text{V}$, $V_{S+} + 0.5\text{V}$	Operating Temperature.....	-40°C to +85°C
Maximum Continuous Output Current.....	30mA	Power Dissipation.....	See Curves
Maximum Die Temperature.....	+125°C	ESD Voltage.....	2kV

CAUTION: Stresses above those listed in "Absolute Maximum Ratings" may cause permanent damage to the device. This is a stress only rating and operation of the device at these or any other conditions above those indicated in the operational sections of this specification is not implied.

IMPORTANT NOTE: All parameters having Min/Max specifications are guaranteed. Typical values are for information purposes only. Unless otherwise noted, all tests are at the specified temperature and are pulsed tests, therefore: $T_J = T_C = T_A$

Electrical Specifications $V_{S+} = +5\text{V}$, $V_{S-} = -5\text{V}$, $R_L = 10\text{k}\Omega$ and $C_L = 10\text{pF}$ to 0V, $T_A = 25^\circ\text{C}$ unless otherwise specified.

PARAMETER	DESCRIPTION	CONDITION	MIN	TYP	MAX	UNIT
INPUT CHARACTERISTICS						
V_{OS}	Input Offset Voltage	$V_{CM} = 0\text{V}$		2	12	mV
TCV_{OS}	Average Offset Voltage Drift	(Note 1)		5		$\mu\text{V}/^\circ\text{C}$
I_B	Input Bias Current	$V_{CM} = 0\text{V}$		2	50	nA
R_{IN}	Input Impedance			1		$\text{G}\Omega$
C_{IN}	Input Capacitance			1.35		pF
A_V	Voltage Gain	$-4.5\text{V} \leq V_{OUT} \leq 4.5\text{V}$	0.995		1.005	V/V
OUTPUT CHARACTERISTICS						
V_{OL}	Output Swing Low	$I_L = -5\text{mA}$		-4.92	-4.85	V
V_{OH}	Output Swing High	$I_L = 5\text{mA}$	4.85	4.92		V
I_{SC}	Short Circuit Current	Short to GND		± 120		mA
POWER SUPPLY PERFORMANCE						
PSRR	Power Supply Rejection Ratio	V_S is moved from $\pm 2.25\text{V}$ to $\pm 7.75\text{V}$	60	80		dB
I_S	Supply Current (Per Buffer)	No load		500	750	μA
DYNAMIC PERFORMANCE						
SR	Slew Rate (Note 2)	$-4.0\text{V} \leq V_{OUT} \leq 4.0\text{V}$, 20% to 80%	7	10		$\text{V}/\mu\text{s}$
t_S	Settling to +0.1%	$V_O = 2\text{V}$ step		500		ns
BW	-3dB Bandwidth	$R_L = 10\text{k}\Omega$, $C_L = 10\text{pF}$		12		MHz
CS	Channel Separation	$f = 5\text{MHz}$		75		dB

NOTES:

1. Measured over the operating temperature range
2. Slew rate is measured on rising and falling edges

EL5221

Electrical Specifications $V_{S+} = +5V$, $V_{S-} = 0V$, $R_L = 10k\Omega$ and $C_L = 10pF$ to 2.5V, $T_A = 25^\circ C$ unless otherwise specified.

PARAMETER	DESCRIPTION	CONDITION	MIN	TYP	MAX	UNIT
INPUT CHARACTERISTICS						
V_{OS}	Input Offset Voltage	$V_{CM} = 2.5V$		2	10	mV
TCV_{OS}	Average Offset Voltage Drift	(Note 1)		5		$\mu V/^\circ C$
I_B	Input Bias Current	$V_{CM} = 2.5V$		2	50	nA
R_{IN}	Input Impedance			1		$G\Omega$
C_{IN}	Input Capacitance			1.35		pF
A_V	Voltage Gain	$0.5 \leq V_{OUT} \leq 4.5V$	0.995		1.005	V/V
OUTPUT CHARACTERISTICS						
V_{OL}	Output Swing Low	$I_L = -5mA$		80	150	mV
V_{OH}	Output Swing High	$I_L = 5mA$	4.85	4.92		V
I_{SC}	Short Circuit Current	Short to GND		± 120		mA
POWER SUPPLY PERFORMANCE						
PSRR	Power Supply Rejection Ratio	V_S is moved from 4.5V to 15.5V	60	80		dB
I_S	Supply Current (Per Buffer)	No Load		500	750	μA
DYNAMIC PERFORMANCE						
SR	Slew Rate (Note 2)	$1V \leq V_{OUT} \leq 4V$, 20% to 80%	7	10		$V/\mu s$
t_S	Settling to +0.1%	$V_O = 2V$ Step		500		ns
BW	-3dB Bandwidth	$R_L = 10k\Omega$, $C_L = 10pF$		12		MHz
CS	Channel Separation	$f = 5MHz$		75		dB

NOTES:

1. Measured over the operating temperature range
2. Slew rate is measured on rising and falling edges

EL5221

Electrical Specifications $V_{S+} = +15V$, $V_{S-} = 0V$, $R_L = 10k\Omega$ and $C_L = 10pF$ to 7.5V, $T_A = 25^\circ C$ unless otherwise specified.

PARAMETER	DESCRIPTION	CONDITION	MIN	TYP	MAX	UNIT
INPUT CHARACTERISTICS						
V_{OS}	Input Offset Voltage	$V_{CM} = 7.5V$		2	14	mV
TCV_{OS}	Average Offset Voltage Drift	(Note 1)		5		$\mu V/^\circ C$
I_B	Input Bias Current	$V_{CM} = 7.5V$		2	50	nA
R_{IN}	Input Impedance			1		$G\Omega$
C_{IN}	Input Capacitance			1.35		pF
A_V	Voltage Gain	$0.5 \leq V_{OUT} \leq 14.5V$	0.995		1.005	V/V
OUTPUT CHARACTERISTICS						
V_{OL}	Output Swing Low	$I_L = -5mA$		80	150	mV
V_{OH}	Output Swing High	$I_L = 5mA$	14.85	14.92		V
I_{SC}	Short Circuit Current	Short to GND		± 120		mA
POWER SUPPLY PERFORMANCE						
PSRR	Power Supply Rejection Ratio	V_S is moved from 4.5V to 15.5V	60	80		dB
I_S	Supply Current (Per Buffer)	No Load		500	750	μA
DYNAMIC PERFORMANCE						
SR	Slew Rate (Note 2)	$1V \leq V_{OUT} \leq 14V$, 20% to 80%	7	10		$V/\mu s$
t_S	Settling to +0.1%	$V_O = 2V$ Step		500		ns
BW	-3dB Bandwidth	$R_L = 10k\Omega$, $C_L = 10pF$		12		MHz
CS	Channel Separation	$f = 5MHz$		75		dB

NOTES:

1. Measured over the operating temperature range
2. Slew rate is measured on rising and falling edges

Typical Performance Curves

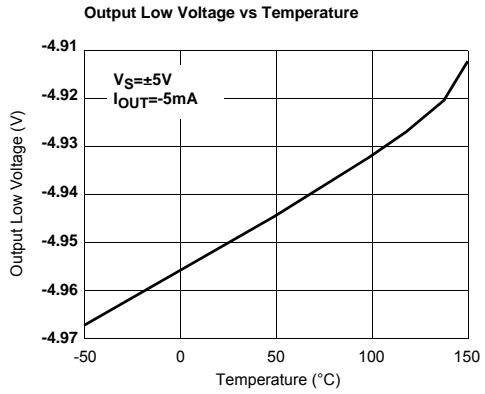
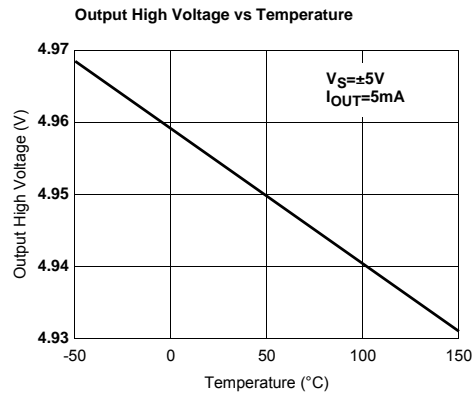
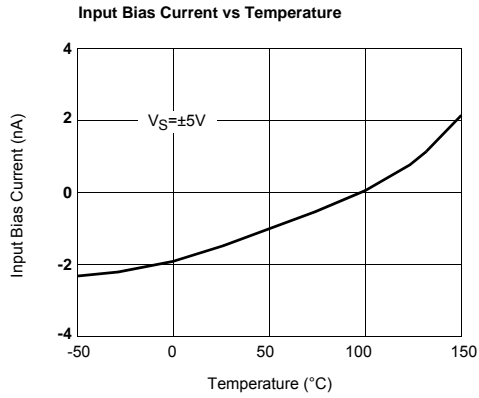
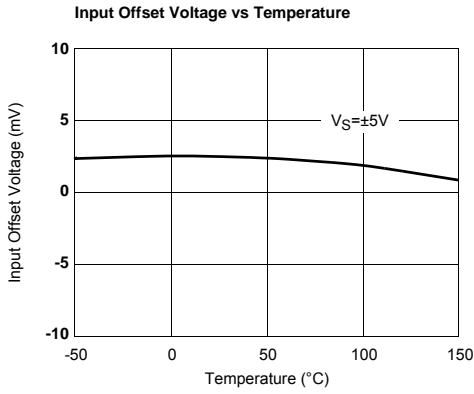
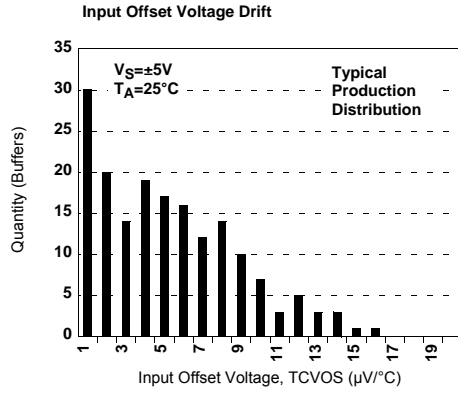
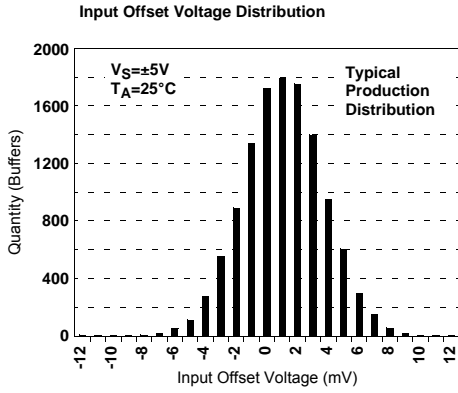

Typical Performance Curves (Continued)

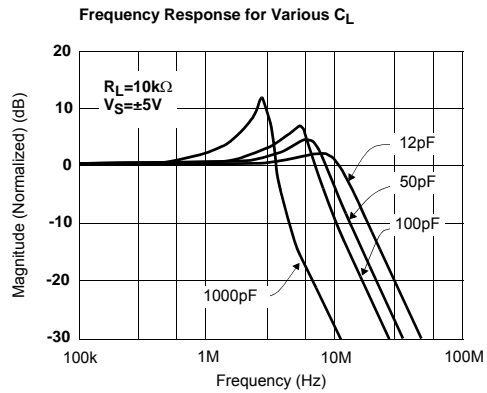
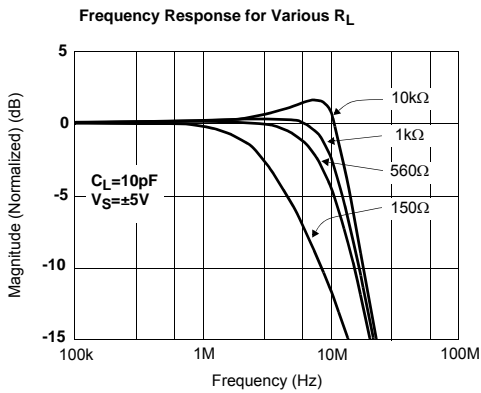
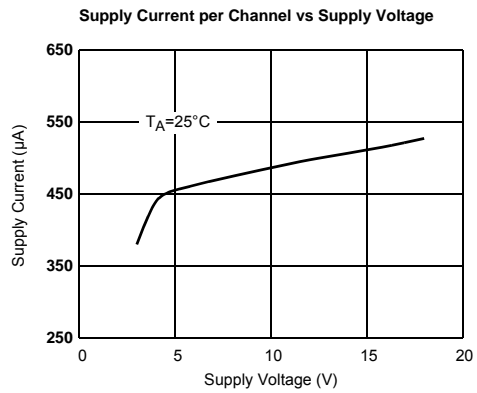
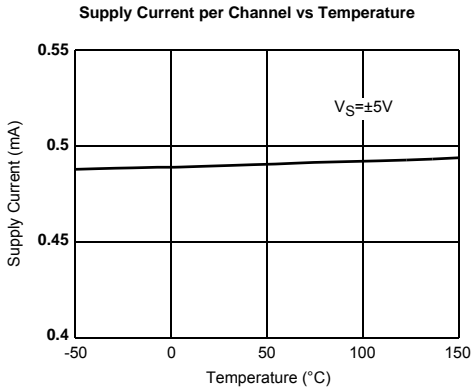
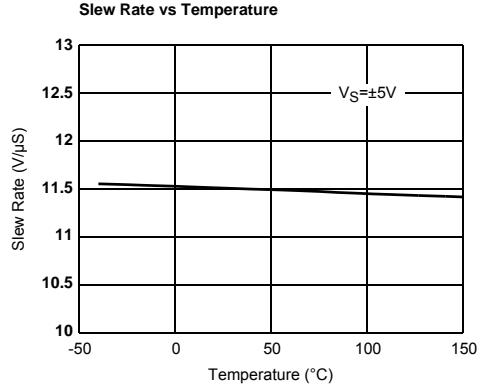
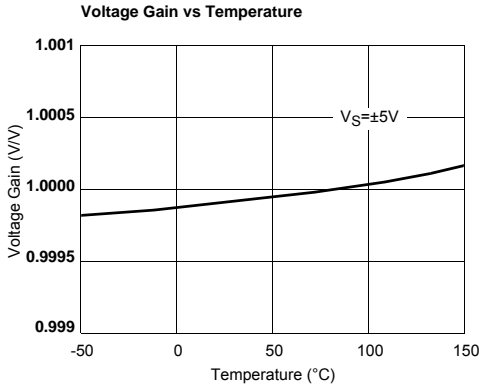

Typical Performance Curves (Continued)

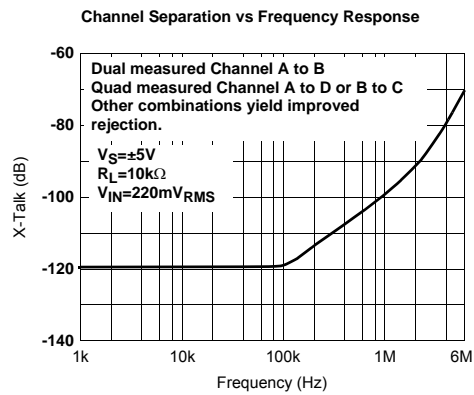
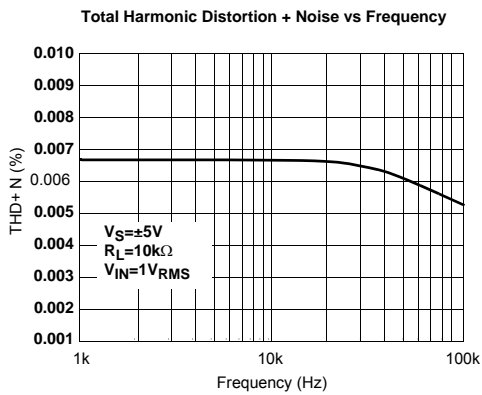
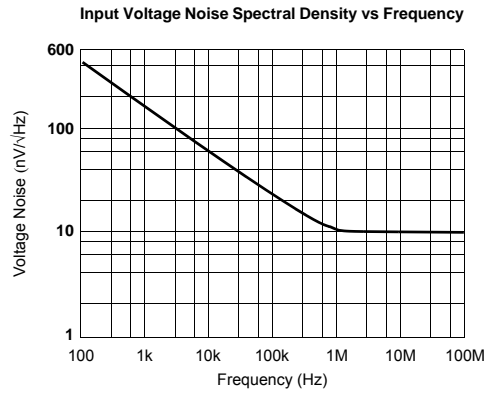
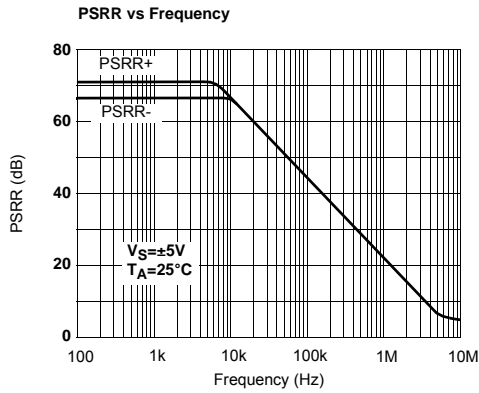
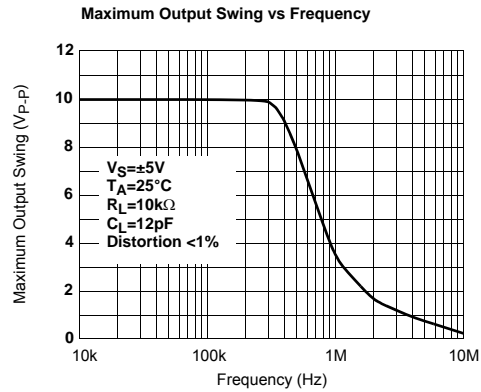
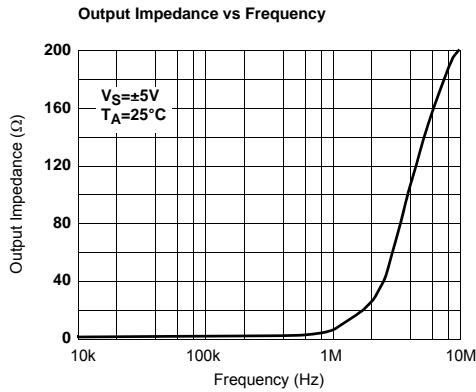

Typical Performance Curves (Continued)

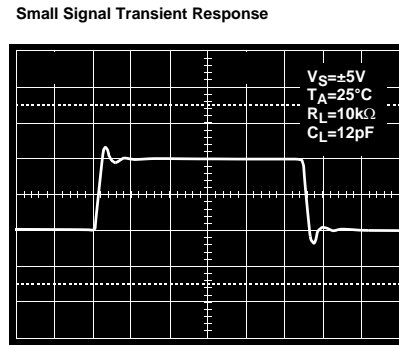
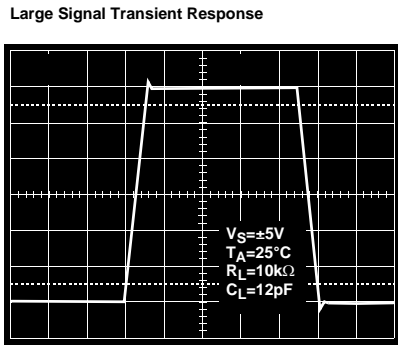
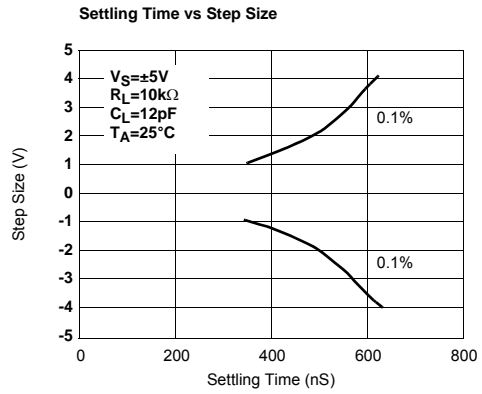
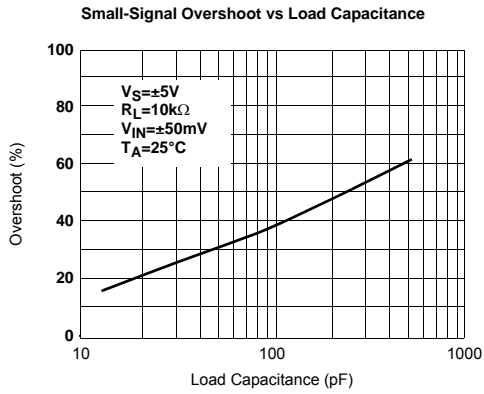

Pin Descriptions

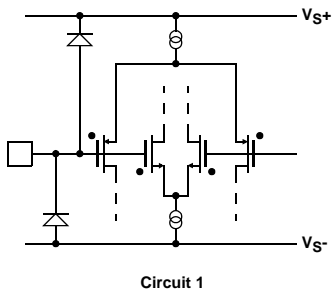
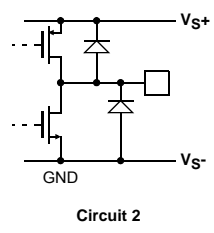
SOT23-6	MSOP-8	PIN NAME	FUNCTION	EQUIVALENT CIRCUIT
1	3	VINA	Buffer A Input	 Circuit 1
2	4	VS-	Negative Supply Voltage	
3	5	VINB	Buffer B Input	(Reference Circuit 1)
4	7	VOUTB	Buffer B Output	 Circuit 2
5	8	VS+	Positive Supply Voltage	
6	1	VOUTA	Buffer A Output	(Reference Circuit 2)

Applications Information

Product Description

The EL5221 unity gain buffer is fabricated using a high voltage CMOS process. It exhibits rail-to-rail input and output capability and has low power consumption (500µA per buffer). These features make the EL5221 ideal for a wide range of general-purpose applications. When driving a load of 10kΩ and 12pF, the EL5221 has a -3dB bandwidth of 12MHz and exhibits 10V/µs slew rate.

Operating Voltage, Input, and Output

The EL5221 is specified with a single nominal supply voltage from 5V to 15V or a split supply with its total range from 5V to 15V. Correct operation is guaranteed for a supply range of 4.5V to 16.5V. Most EL5221 specifications are stable over both the full supply range and operating temperatures of -40°C to +85°C. Parameter variations with operating voltage and/or temperature are shown in the typical performance curves.

The output swings of the EL5221 typically extend to within 80mV of positive and negative supply rails with load currents of 5mA. Decreasing load currents will extend the output voltage range even closer to the supply rails. Figure 1 shows the input and output waveforms for the device. Operation is from ±5V supply with a 10kΩ load connected to GND. The

input is a 10V_{P-P} sinusoid. The output voltage is approximately 9.985V_{P-P}.

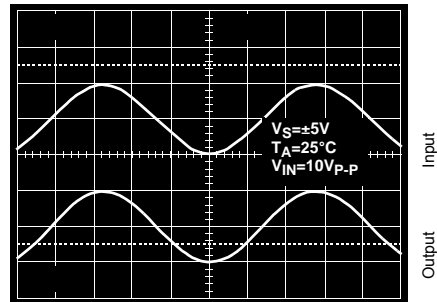

FIGURE 1. OPERATION WITH RAIL-TO-RAIL INPUT AND OUTPUT

Short Circuit Current Limit

The EL5221 will limit the short circuit current to ±120mA if the output is directly shorted to the positive or the negative supply. If an output is shorted indefinitely, the power dissipation could easily increase such that the device may be damaged. Maximum reliability is maintained if the output continuous current never exceeds ±30mA. This limit is set by the design of the internal metal interconnects.

Output Phase Reversal

The EL5221 is immune to phase reversal as long as the input voltage is limited from VS- -0.5V to VS+ +0.5V. Figure 2 shows a photo of the output of the device with the input

voltage driven beyond the supply rails. Although the device's output will not change phase, the input's overvoltage should be avoided. If an input voltage exceeds supply voltage by more than 0.6V, electrostatic protection diodes placed in the input stage of the device begin to conduct and overvoltage damage could occur.

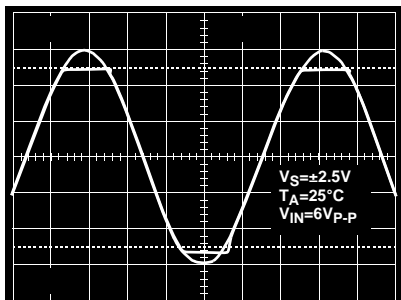

FIGURE 2. OPERATION WITH BEYOND-THE-RAILS INPUT

Power Dissipation

With the high-output drive capability of the EL5221 buffer, it is possible to exceed the 125°C 'absolute-maximum junction temperature' under certain load current conditions. Therefore, it is important to calculate the maximum junction temperature for the application to determine if load conditions need to be modified for the buffer to remain in the safe operating area.

The maximum power dissipation allowed in a package is determined according to:

$$P_{DMAX} = \frac{T_{JMAX} - T_{AMAX}}{\Theta_{JA}}$$

where:

T_{JMAX} = Maximum junction temperature

T_{AMAX} = Maximum ambient temperature

Θ_{JA} = Thermal resistance of the Package

P_{DMAX} = Maximum power dissipation in the package

The maximum power dissipation actually produced by an IC is the total quiescent supply current times the total power supply voltage, plus the power in the IC due to the loads, or:

$$P_{DMAX} = \Sigma i[V_S \times I_{SMAX} + (V_{S+} - V_{OUTi}) \times I_{LOADi}]$$

when sourcing, and:

$$P_{DMAX} = \Sigma i[V_S \times I_{SMAX} + (V_{OUTi} - V_{S-}) \times I_{LOADi}]$$

when sinking.

where:

$i = 1$ to 2 for dual buffer

V_S = Total supply voltage

I_{SMAX} = Maximum supply current per channel

V_{OUTi} = Maximum output voltage of the application

I_{LOADi} = Load current

If we set the two P_{DMAX} equations equal to each other, we can solve for R_{LOADi} to avoid device overheat. Figure 3 and Figure 4 provide a convenient way to see if the device will overheat. The maximum safe power dissipation can be found graphically, based on the package type and the ambient temperature. By using the previous equation, it is a simple matter to see if P_{DMAX} exceeds the device's power derating curves. To ensure proper operation, it is important to observe the recommended derating curves shown in Figure 3 and Figure 4.

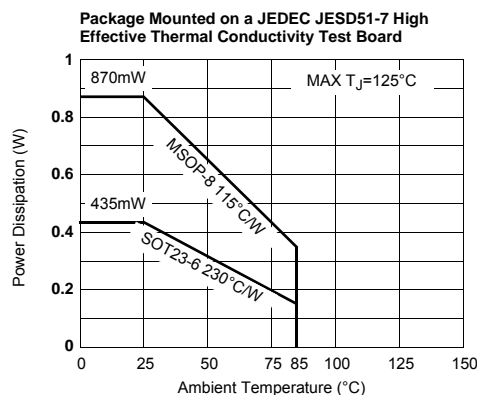

FIGURE 3. PACKAGE POWER DISSIPATION VS AMBIENT TEMPERATURE

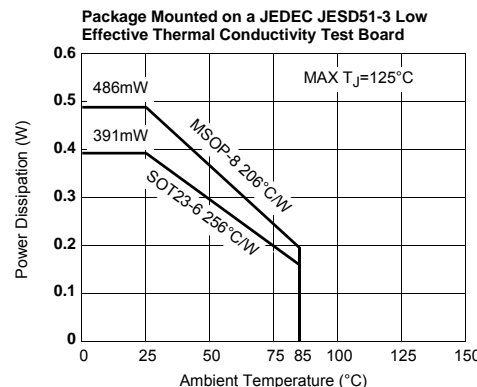

FIGURE 4. PACKAGE POWER DISSIPATION VS AMBIENT TEMPERATURE

Unused Buffers

It is recommended that any unused buffer have the input tied to the ground plane.

Driving Capacitive Loads

The EL5221 can drive a wide range of capacitive loads. As load capacitance increases, however, the -3dB bandwidth of the device will decrease and the peaking increase. The buffers drive 10pF loads in parallel with 10k Ω with just 1.5dB of peaking, and 100pF with 6.4dB of peaking. If less peaking is desired in these applications, a small series resistor (usually between 5 Ω and 50 Ω) can be placed in series with the output. However, this will obviously reduce the gain slightly. Another method of reducing peaking is to add a "snubber" circuit at the output. A snubber is a shunt load consisting of a resistor in series with a capacitor. Values of 150 Ω and 10nF are typical. The advantage of a snubber is that it does not draw any DC load current or reduce the gain

Power Supply Bypassing and Printed Circuit Board Layout

The EL5221 can provide gain at high frequency. As with any high frequency device, good printed circuit board layout is necessary for optimum performance. Ground plane construction is highly recommended, lead lengths should be as short as possible, and the power supply pins must be well bypassed to reduce the risk of oscillation. For normal single supply operation, where the V_{S-} pin is connected to ground, a 0.1 μ F ceramic capacitor should be placed from V_{S+} to pin to V_{S-} pin. A 4.7 μ F tantalum capacitor should then be connected in parallel, placed in the region of the buffer. One 4.7 μ F capacitor may be used for multiple devices. This same capacitor combination should be placed at each supply pin to ground if split supplies are to be used.

All Intersil U.S. products are manufactured, assembled and tested utilizing ISO9000 quality systems. Intersil Corporation's quality certifications can be viewed at www.intersil.com/design/quality

Intersil products are sold by description only. Intersil Corporation reserves the right to make changes in circuit design, software and/or specifications at any time without notice. Accordingly, the reader is cautioned to verify that data sheets are current before placing orders. Information furnished by Intersil is believed to be accurate and reliable. However, no responsibility is assumed by Intersil or its subsidiaries for its use; nor for any infringements of patents or other rights of third parties which may result from its use. No license is granted by implication or otherwise under any patent or patent rights of Intersil or its subsidiaries.

For information regarding Intersil Corporation and its products, see www.intersil.com