

### General Description

This planar stripe MOSFET has better characteristics, such as fast switching time, low on resistance, low gate charge and excellent avalanche characteristics. It is mainly suitable for switching mode power supplies.

### FEATURES

- $V_{DSS} = 600V$ ,  $I_D = 2.0A$
- Drain-Source ON Resistance :  
 $R_{DS(ON)} = 5.0 \Omega @ V_{GS} = 10V$
- $Q_g(\text{typ.}) = 10.9nC$

### MAXIMUM RATING (Tc=25°C)

CHARACTERISTIC	SYMBOL	RATING		UNIT	
		KHB2D0N60P	KHB2D0N60F KHB2D0N60F2		
Drain-Source Voltage	$V_{DSS}$	600		V	
Gate-Source Voltage	$V_{GSS}$	±30		V	
Drain Current	@T <sub>C</sub> =25°C	$I_D$	2.0	2.0*	A
	@T <sub>C</sub> =100°C		1.2	1.2*	
	Pulsed (Note1)	$I_{DP}$	8.0	8.0*	
Single Pulsed Avalanche Energy (Note 2)	$E_{AS}$	120		mJ	
Repetitive Avalanche Energy (Note 1)	$E_{AR}$	5.4		mJ	
Peak Diode Recovery dv/dt (Note 3)	dv/dt	5.5		V/ns	
Drain Power Dissipation	Tc=25°C	$P_D$	54	23	W
	Derate above 25°C		0.43	0.18	W/°C
Maximum Junction Temperature	$T_j$	150		°C	
Storage Temperature Range	$T_{stg}$	-55 ~ 150		°C	
<b>Thermal Characteristics</b>					
Thermal Resistance, Junction-to-Case	$R_{thJC}$	2.32	5.5	°C/W	
Thermal Resistance, Case-to-Sink	$R_{thCS}$	0.5	-	°C/W	
Thermal Resistance, Junction-to-Ambient	$R_{thJA}$	62.5	62.5	°C/W	

\* : Drain current limited by maximum junction temperature.

### PIN CONNECTION

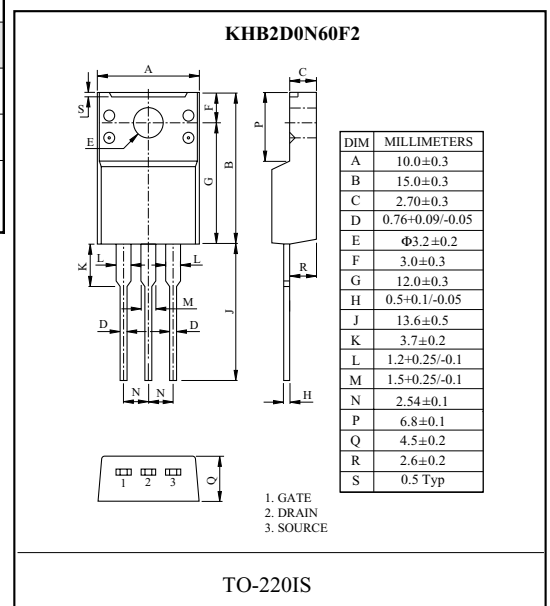
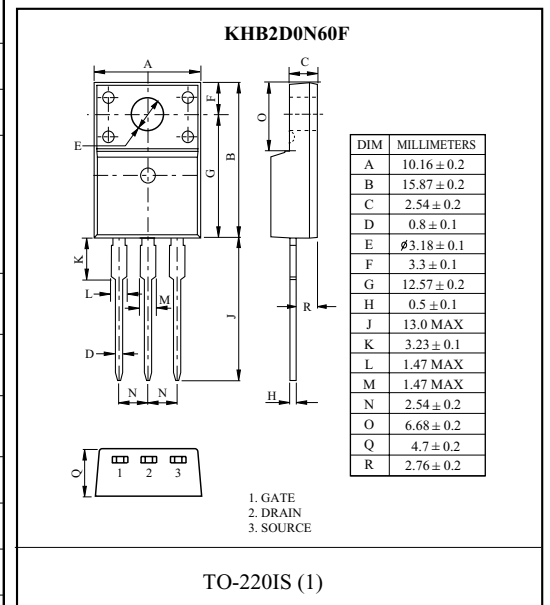
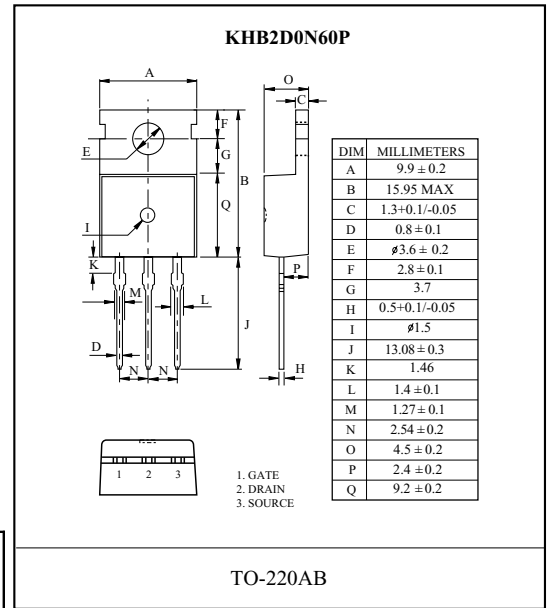
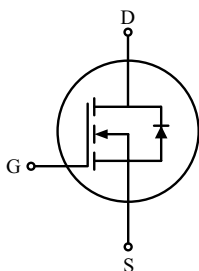

# KHB2D0N60P/F/F2

## ELECTRICAL CHARACTERISTICS (Tc=25 °C)

CHARACTERISTIC	SYMBOL	TEST CONDITION	MIN.	TYP.	MAX.	UNIT
<b>Static</b>						
Drain-Source Breakdown Voltage	$BV_{DSS}$	$I_D=250\mu A, V_{GS}=0V$	600	-	-	V
Breakdown Voltage Temperature Coefficient	$\Delta BV_{DSS}/\Delta T_j$	$I_D=250\mu A$ , Referenced to 25 °C	-	0.65	-	V/°C
Drain Cut-off Current	$I_{DSS}$	$V_{DS}=600V, V_{GS}=0V$ ,	-	-	10	$\mu A$
Gate Threshold Voltage	$V_{th}$	$V_{DS}=V_{GS}, I_D=250\mu A$	2.0	-	4.0	V
Gate Leakage Current	$I_{GSS}$	$V_{GS}=\pm 30V, V_{DS}=0V$	-	-	$\pm 100$	nA
Drain-Source ON Resistance	$R_{DS(ON)}$	$V_{GS}=10V, I_D=1.0A$	-	3.8	5.0	$\Omega$
<b>Dynamic</b>						
Total Gate Charge	$Q_g$	$V_{DS}=480V, I_D=2.0A$ $V_{GS}=10V$ (Note4,5)	-	10.9	12	nC
Gate-Source Charge	$Q_{gs}$		-	1.7	3	
Gate-Drain Charge	$Q_{gd}$		-	5.0	5.5	
Turn-on Delay time	$t_{d(on)}$	$V_{DD}=300V$ $R_L=150\Omega$ $R_G=25\Omega$ (Note4,5)	-	-	28	ns
Turn-on Rise time	$t_r$		-	-	60	
Turn-off Delay time	$t_{d(off)}$		-	-	58	
Turn-off Fall time	$t_f$		-	-	66	
Input Capacitance	$C_{iss}$	$V_{DS}=25V, V_{GS}=0V, f=1.0MHz$	-	388	504	pF
Reverse Transfer Capacitance	$C_{rss}$		-	6.5	8.5	
Output Capacitance	$C_{oss}$		-	46	59.4	
<b>Source-Drain Diode Ratings</b>						
Continuous Source Current	$I_S$	$V_{GS}<V_{th}$	-	-	2.0	A
Pulsed Source Current	$I_{SP}$		-	-	8.0	
Diode Forward Voltage	$V_{SD}$	$I_S=2.0A, V_{GS}=0V$	-	-	1.5	V
Reverse Recovery Time	$t_{rr}$	$I_S=2.0A, V_{GS}=0V$ , $dI_S/dt=100A/\mu s$	-	300	-	ns
Reverse Recovery Charge	$Q_{rr}$		-	1.55	-	$\mu C$

Note 1) Repetivity rating : Pulse width limited by junction temperature.

Note 2)  $L = 36.9mH, I_S = 2.0A, V_{DD} = 50V, R_G = 25\Omega$ , Starting  $T_j = 25\text{ }^\circ\text{C}$ .

Note 3)  $I_S \leq 2.0A, dI/dt \leq 300A/\mu s, V_{DD} \leq BV_{DSS}$ , Starting  $T_j = 25\text{ }^\circ\text{C}$ .

Note 4) Pulse Test : Pulse width  $\leq 300\mu s$ , Duty Cycle  $\leq 2\%$ .

Note 5) Essentially independent of operating temperature.

# KHB2D0N60P/F/F2

Fig1.  $I_D - V_{DS}$

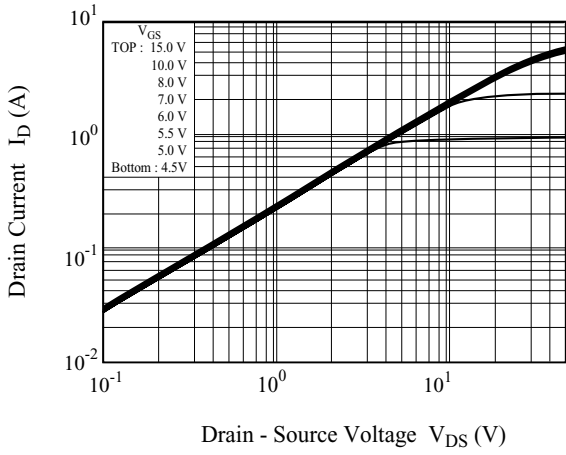

Fig2.  $I_D - V_{GS}$

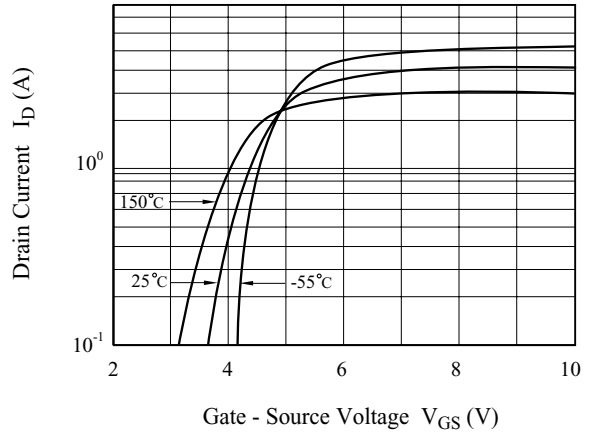

Fig3.  $BV_{DSS} - T_j$

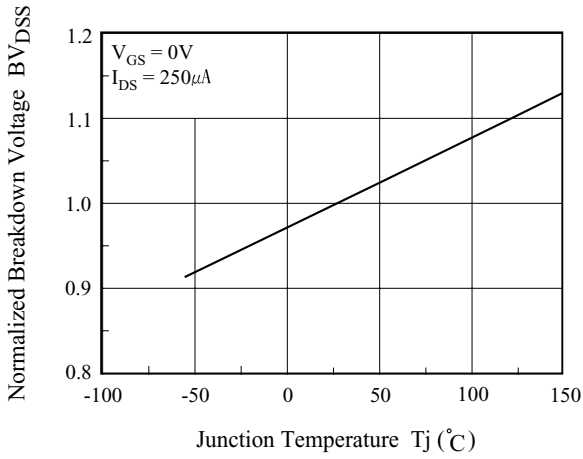

Fig4.  $R_{DS(ON)} - I_D$

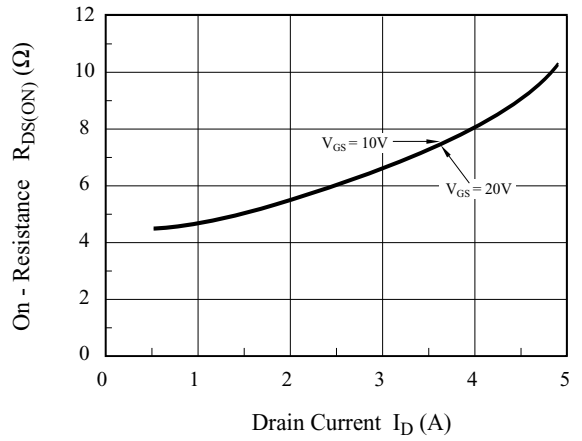

Fig5.  $I_S - V_{SD}$

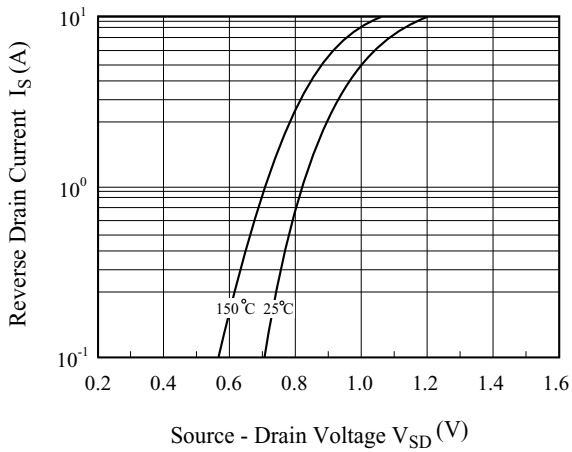
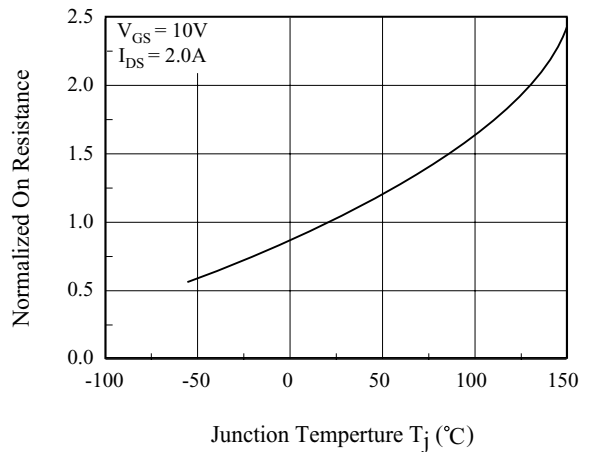

Fig6.  $R_{DS(ON)} - T_j$



# KHB2D0N60P/F/F2

Fig7. C - V<sub>DS</sub>

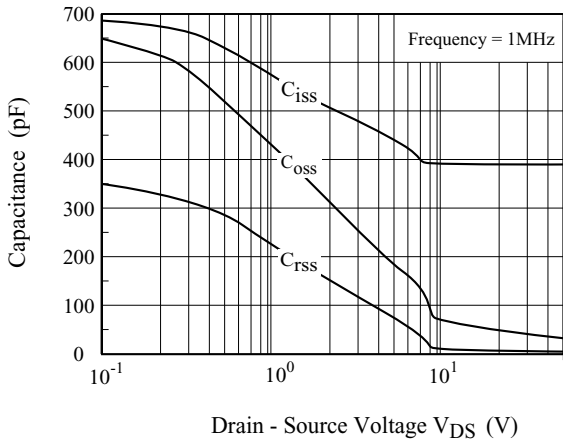

Fig8. Q<sub>g</sub> - V<sub>GS</sub>

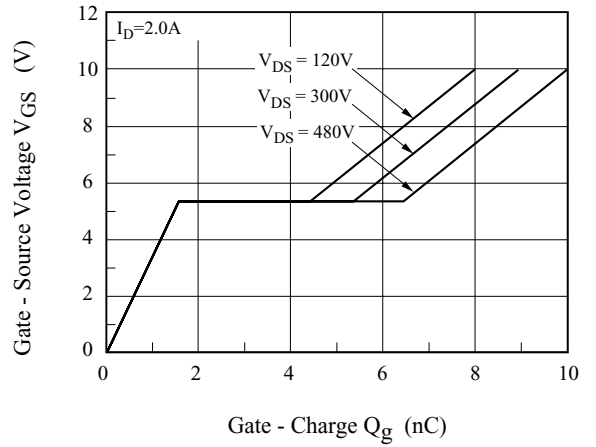

Fig9. Safe Operation Area

(KHB2D0N60P)

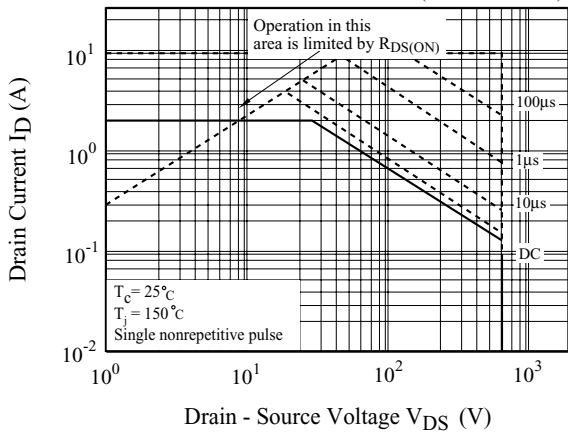

Fig10. Safe Operation Area

(KHB2D0N60F, KHB2D0N60F2)

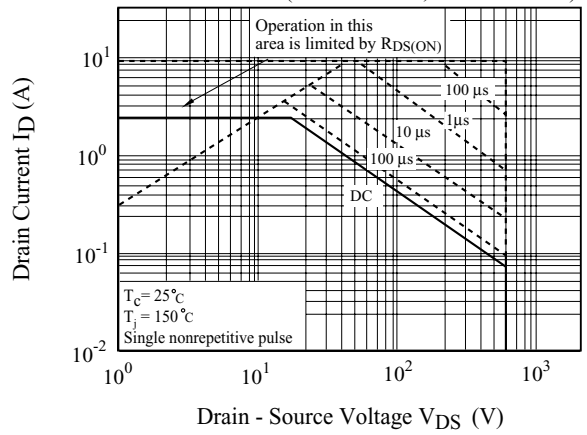

Fig11. I<sub>D</sub> - T<sub>j</sub>

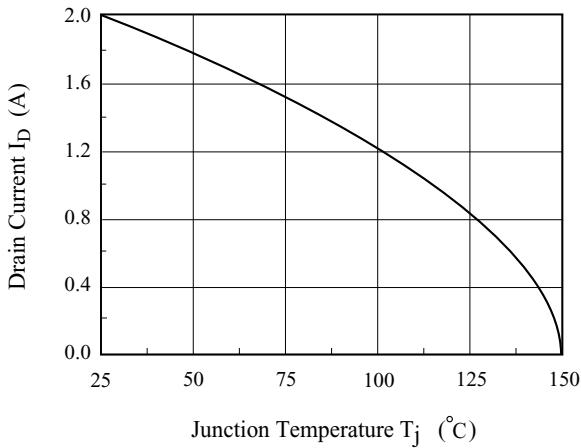

Fig12. Transient Thermal Response Curve

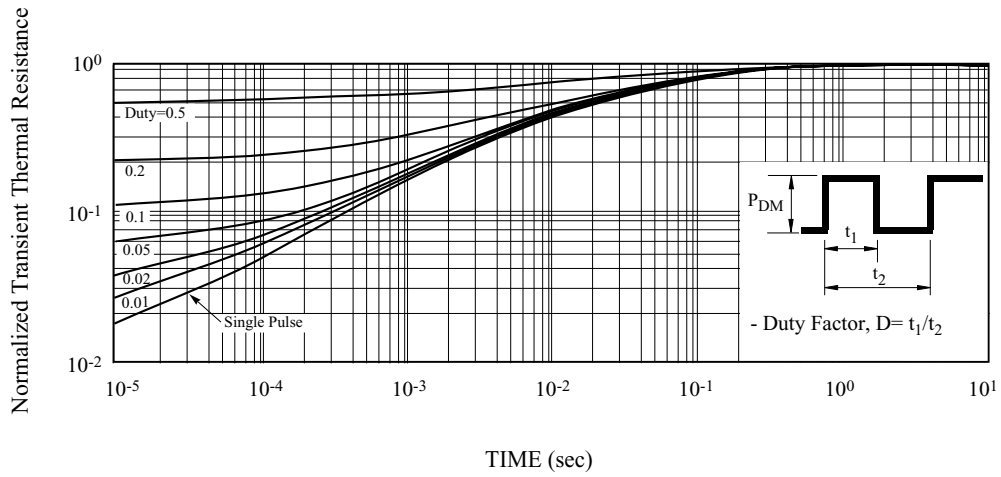
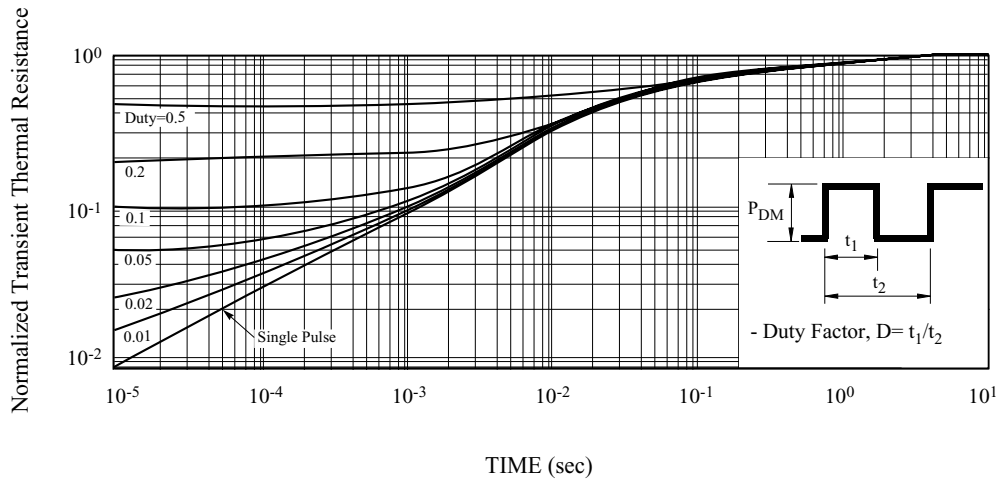

Fig13. Transient Thermal Response Curve



# KHB2D0N60P/F/F2

Fig14. Gate Charge

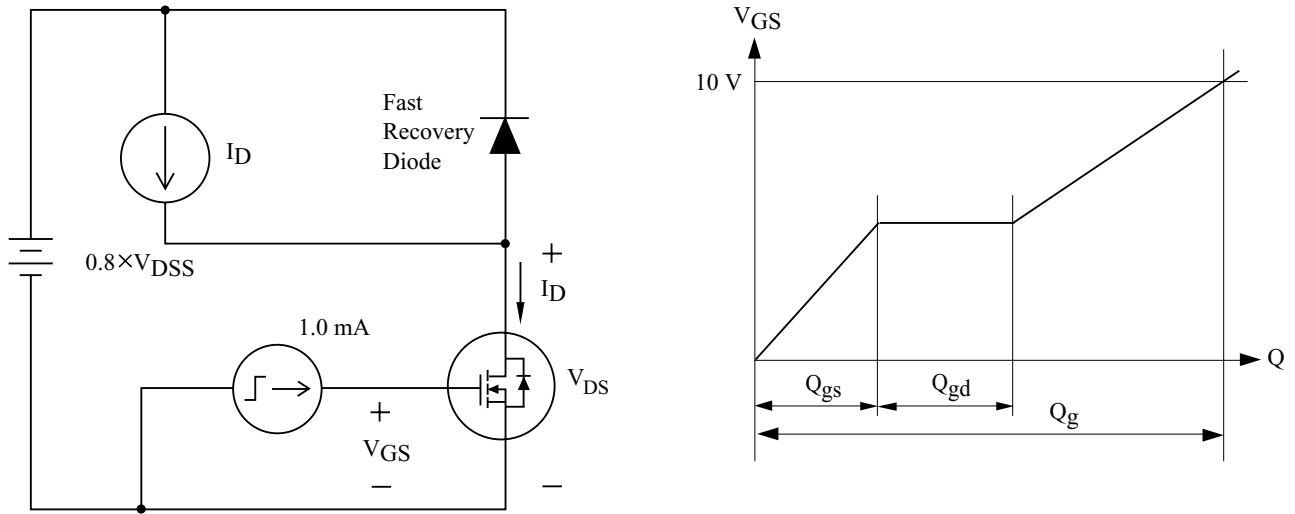

Fig15. Single Pulsed Avalanche Energy

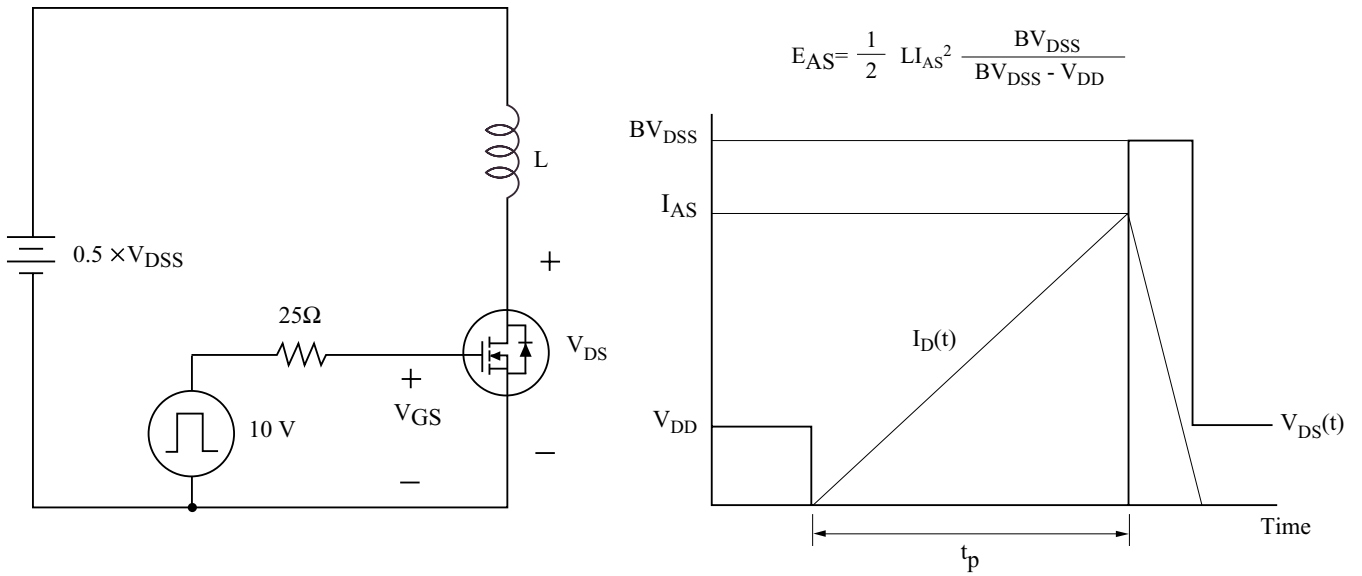

Fig16. Resistive Load Switching

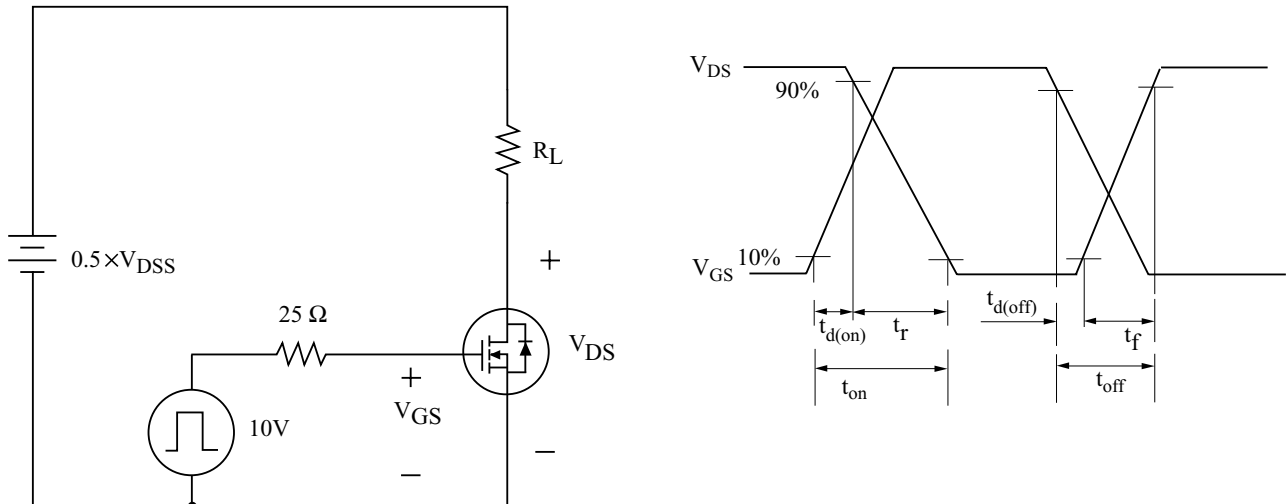

Fig17. Source - Drain Diode Reverse Recovery and  $dv/dt$

