

Low $V_{CE(sat)}$ IGBT High Speed IGBT

IXSH/IXSM 25 N100 IXSH/IXSM 25 N100A

V_{CES}	I_{C25}	$V_{CE(sat)}$
1000 V	50 A	3.5 V
1000 V	50 A	4.0 V

Short Circuit SOA Capability

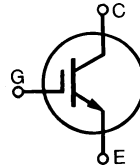

Symbol	Test Conditions	Maximum Ratings	
V_{CES}	$T_J = 25^\circ\text{C}$ to 150°C	1000	V
V_{CGR}	$T_J = 25^\circ\text{C}$ to 150°C ; $R_{GE} = 1\text{ M}\Omega$	1000	V
V_{GES}	Continuous	± 20	V
V_{GEM}	Transient	± 30	V
I_{C25}	$T_C = 25^\circ\text{C}$	50	A
I_{C90}	$T_C = 90^\circ\text{C}$	25	A
I_{CM}	$T_C = 25^\circ\text{C}$, 1 ms	100	A
SSOA (RBSOA)	$V_{GE} = 15\text{ V}$, $T_J = 125^\circ\text{C}$, $R_G = 4.7\ \Omega$ Clamped inductive load, $L = 30\ \mu\text{H}$	$I_{CM} = 50$ @ $0.8\ V_{CES}$	A
t_{SC} (SCSOA)	$V_{GE} = 15\text{ V}$, $V_{CE} = 0.6 \cdot V_{CES}$, $T_J = 125^\circ\text{C}$ $R_G = 33\ \Omega$, non repetitive	10	μs
P_c	$T_C = 25^\circ\text{C}$	200	W
T_J		-55 ... +150	$^\circ\text{C}$
T_{JM}		150	$^\circ\text{C}$
T_{stg}		-55 ... +150	$^\circ\text{C}$
M_d	Mounting torque	1.13/10	Nm/lb.in.
Weight g		TO-204 = 18 g, TO-247 = 6	
	Maximum lead temperature for soldering 1.6 mm (0.062 in.) from case for 10 s	300	$^\circ\text{C}$

Symbol	Test Conditions	Characteristic Values ($T_J = 25^\circ\text{C}$, unless otherwise specified)		
		min.	typ.	max.
BV_{CES}	$I_C = 3\text{ mA}$, $V_{GE} = 0\text{ V}$	1000		V
$V_{GE(th)}$	$I_C = 2.5\text{ mA}$, $V_{CE} = V_{GE}$	5		8 V
I_{CES}	$V_{CE} = 0.8 \cdot V_{CES}$, $T_J = 25^\circ\text{C}$ $V_{GE} = 0\text{ V}$, $T_J = 125^\circ\text{C}$			250 μA 1 mA
I_{GES}	$V_{CE} = 0\text{ V}$, $V_{GE} = \pm 20\text{ V}$			$\pm 100\text{ nA}$
$V_{CE(sat)}$	$I_C = I_{C90}$, $V_{GE} = 15\text{ V}$	25N100 25N100A		3.5 V 4.0 V

TO-247 AD (IXSH)

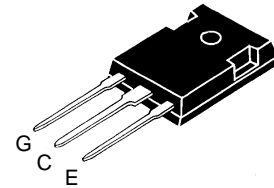

TO-204 AE (IXSM)

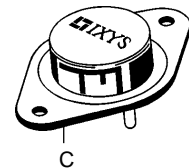

G = Gate, C = Collector,
E = Emitter, TAB = Collector

Features

- International standard packages
- Guaranteed Short Circuit SOA capability
- Low $V_{CE(sat)}$
 - for low on-state conduction losses
- High current handling capability
- MOS Gate turn-on
 - drive simplicity
- Fast Fall Time for switching speeds up to 20 kHz

Applications

- AC motor speed control
- Uninterruptible power supplies (UPS)
- Welding

Advantages

- Easy to mount with 1 screw (TO-247) (isolated mounting screw hole)
- High power density

Symbol	Test Conditions	Characteristic Values ($T_J = 25^\circ\text{C}$, unless otherwise specified)		
		min.	typ.	max.
g_{fs}	$I_C = I_{C90}$; $V_{CE} = 10\text{ V}$, Pulse test, $t \leq 300\ \mu\text{s}$, duty cycle $d \leq 2\%$	10	17	S
$I_{C(on)}$	$V_{GE} = 15\text{ V}$, $V_{CE} = 10\text{ V}$		140	A
C_{ies}	$V_{CE} = 25\text{ V}$, $V_{GE} = 0\text{ V}$, $f = 1\text{ MHz}$		2850	pF
C_{oes}			210	pF
C_{res}			50	pF
Q_g	$I_C = I_{C90}$, $V_{GE} = 15\text{ V}$, $V_{CE} = 0.5 V_{CES}$		112	nC
Q_{ge}			28	nC
Q_{gc}			50	nC
$t_{d(on)}$	Inductive load, $T_J = 25^\circ\text{C}$ $I_C = I_{C90}$, $V_{GE} = 15\text{ V}$, $L = 100\ \mu\text{H}$ $V_{CE} = 0.8 V_{CES}$, $R_G = 4.7\ \Omega$ Remarks: Switching times may increase for higher T_J or increased R_G		70	ns
t_{ri}			580	ns
$t_{d(off)}$			150	ns
t_{fi}			1200	ns
t_{fi}			800	ns
E_{off}			10	mJ
E_{off}			8	mJ
$t_{d(on)}$	Inductive load, $T_J = 125^\circ\text{C}$ $I_C = I_{C90}$, $V_{GE} = 15\text{ V}$, $L = 100\ \mu\text{H}$ $V_{CE} = 0.8 V_{CES}$, $R_G = 4.7\ \Omega$ Remarks: Switching times may increase for higher T_J or increased R_G		70	ns
t_{ri}			580	ns
E_{on}			4.2	mJ
$t_{d(off)}$			200	550 ns
t_{fi}			1500	3000 ns
E_{off}		1000	1500 ns	
E_{off}			15	mJ
E_{off}			11	mJ
R_{thJC}				0.63 K/W
R_{thCK}			0.25	K/W

TO-247 AD Outline

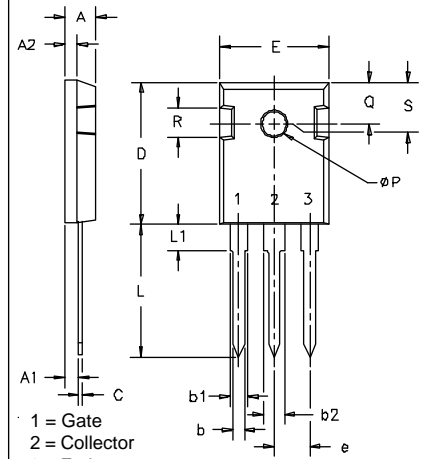

SYM	INCHES		MILLIMETERS	
	MIN	MAX	MIN	MAX
A	.185	.209	4.7	5.3
A1	.087	.102	2.2	2.54
A2	.059	.098	2.2	2.6
b	.040	.055	1.0	1.4
b1	.065	.084	1.65	2.13
b2	.113	.123	2.87	3.12
C	.016	.031	.4	.8
D	.819	.845	20.80	21.46
E	.610	.640	15.75	16.26
e	.215 BSC		5.45 BSC	
L	.780	.800	19.81	20.32
L1		.177		4.50
ϕP	.140	.144	3.55	3.65
Q	.212	.244	5.4	6.2
R	.170	.216	4.32	5.49
S	.242 BSC		6.15 BSC	

TO-204AE Outline

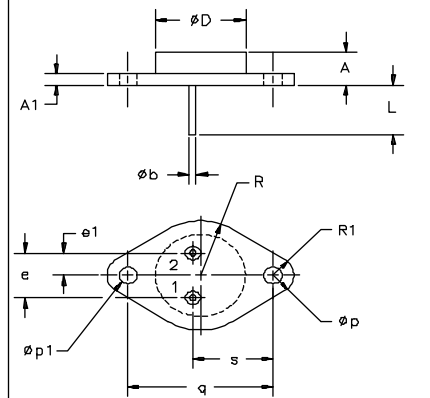

SYM	INCHES		MILLIMETERS	
	MIN	MAX	MIN	MAX
A	.250	.450	6.4	11.4
A1	.060	.135	1.53	3.42
ϕb	.057	.063	1.45	1.60
ϕD		.875		22.22
e	.420	.440	10.67	11.17
e1	.205	.225	5.21	5.71
L	.440	.480	11.18	12.19
ϕp	.151	.165	3.84	4.19
$\phi p1$.151	.165	3.84	4.19
q	1.187 BSC		30.15 BSC	
R	.495	.525	12.58	13.33
R1	.131	.188	3.33	4.77
s	.655	.675	16.64	17.14

IXYS reserves the right to change limits, test conditions, and dimensions.

IXYS Corporation
 3540 Bassett Street Santa Clara, CA 95054

IXYS Semiconductor GmbH
 Edisonstr. 15, D-68623 Lampertheim
 Phone: +49-6206-503-0, Fax: +49-6206-503627

IXYS MOSFETs and IGBTs are covered by one of the following U.S. patents: 4,835,592 4,881,108 5,017,508 5,049,961 5,187,117 5,486,715 4,850,072 4,931,844 5,034,796 5,063,307 5,237,481 5,381,025

Fig. 1 Saturation Characteristics

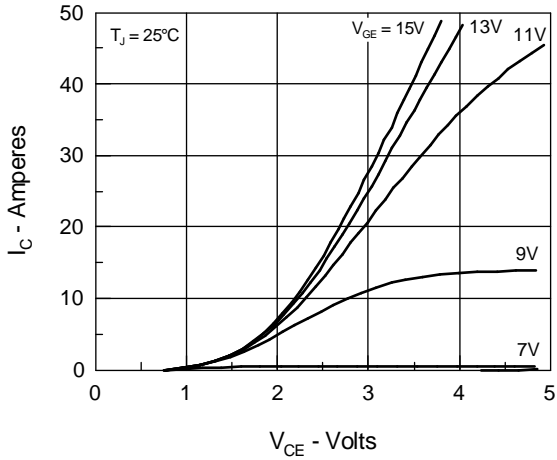

Fig. 2 Output Characteristics

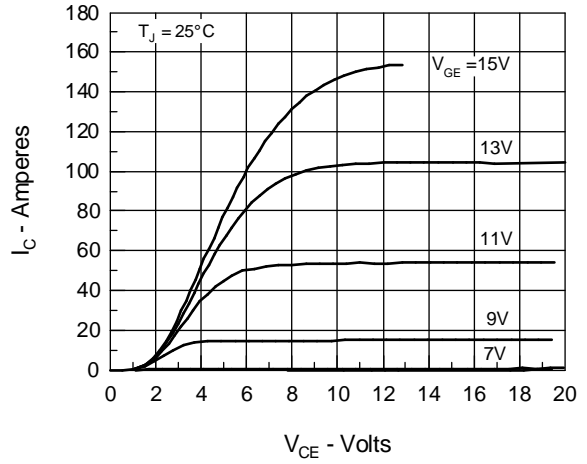

Fig. 3 Collector-Emitter Voltage vs. Gate-Emitter Voltage

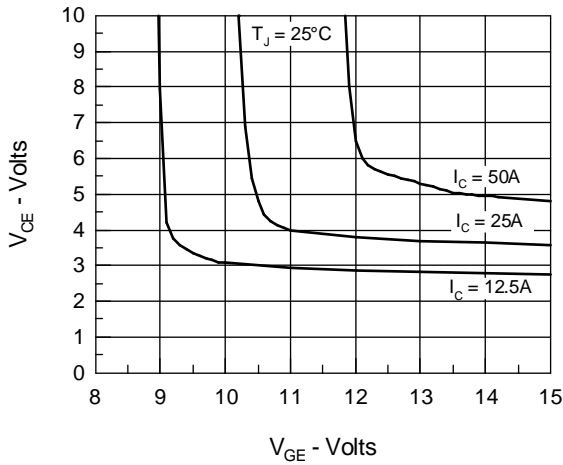

Fig. 4 Temperature Dependence of Output Saturation Voltage

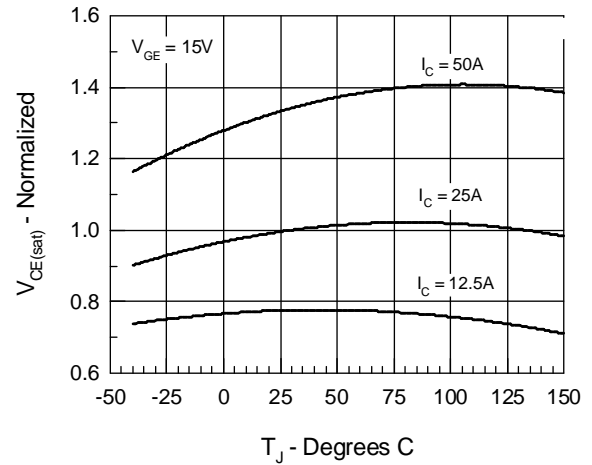

Fig. 5 Input Admittance

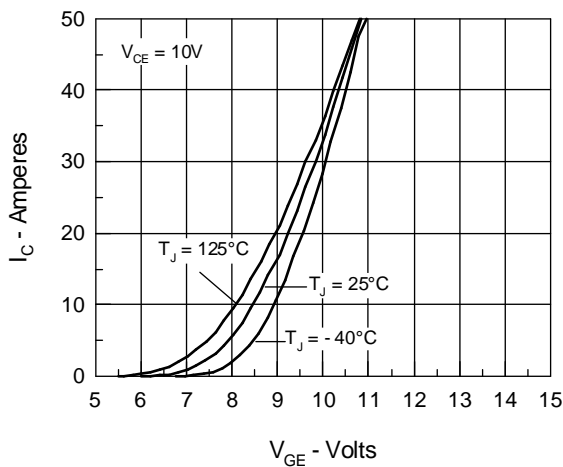

Fig. 6 Temperature Dependence of Breakdown and Threshold Voltage

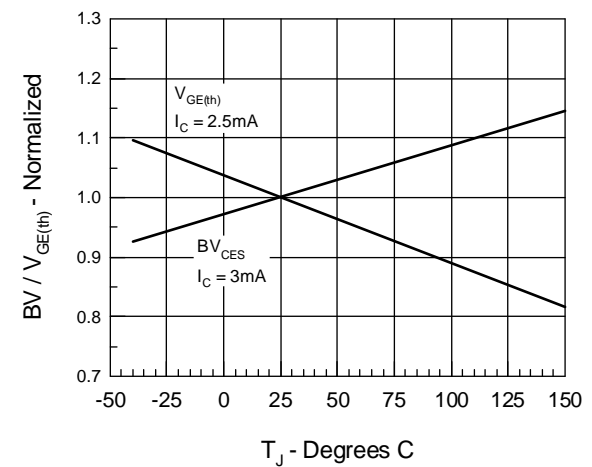

Fig.7 Turn-Off Energy per Pulse and Fall Time on Collector Current

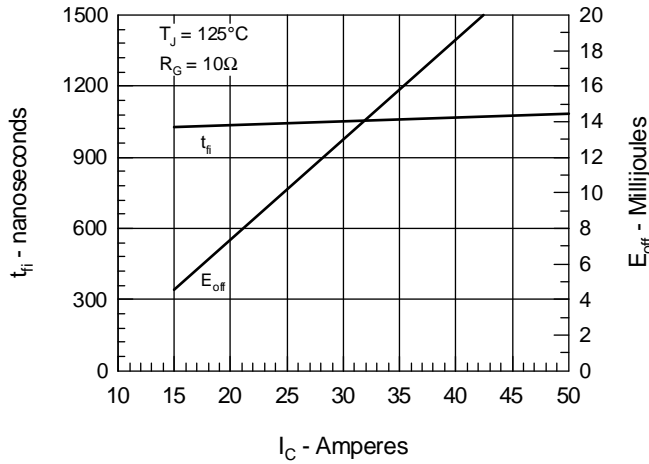

Fig.8 Dependence of Turn-Off Energy Per Pulse and Fall Time on R_G

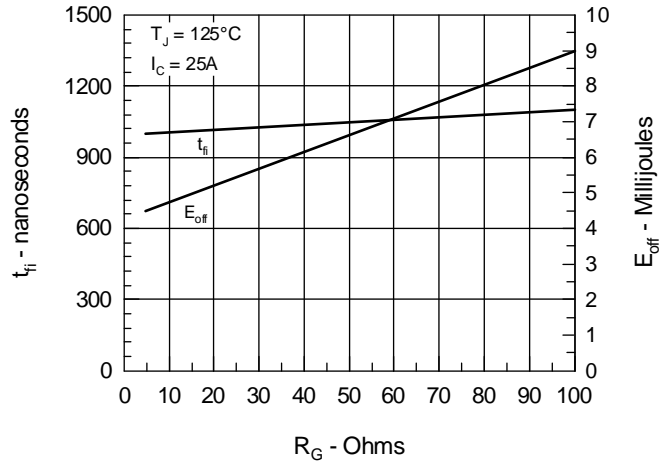

Fig.9 Gate Charge Characteristic Curve

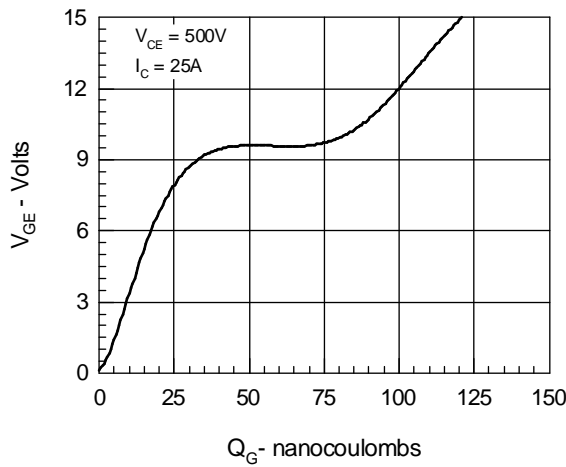

Fig.10 Turn-Off Safe Operating Area

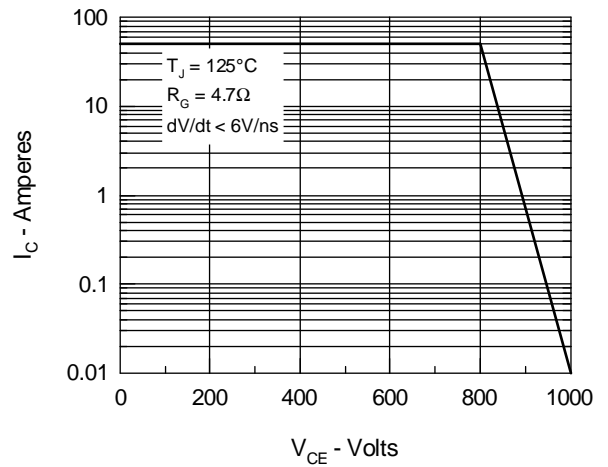
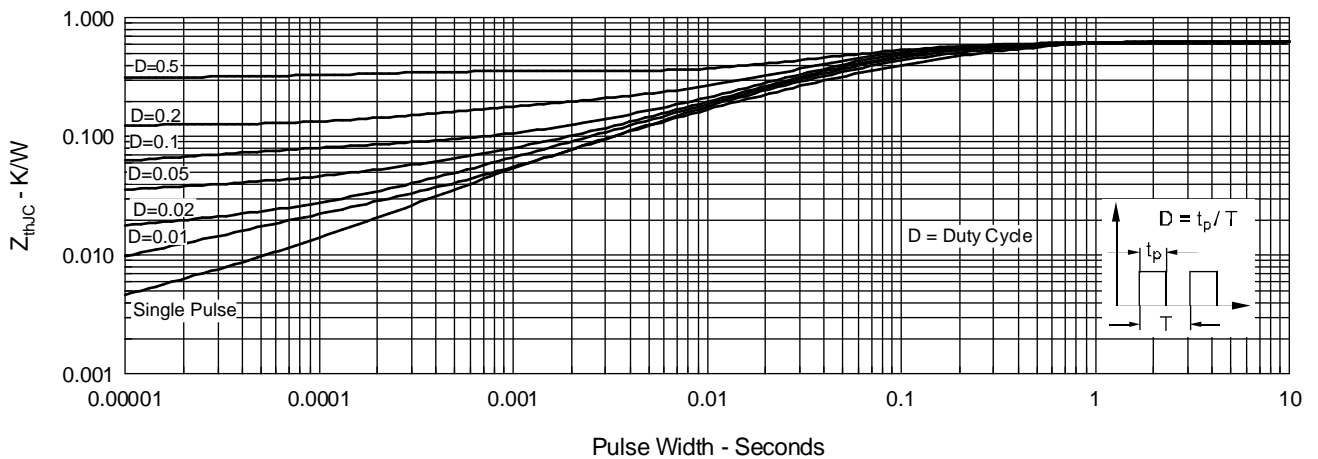

Fig.11 Transient Thermal Impedance



IXYS reserves the right to change limits, test conditions, and dimensions.

© IXYS Corporation. All rights reserved.

IXYS Corporation
3540 Bassett Street, Santa Clara CA 95054
Phone: 408-982-0700, Fax: 408-496-0670

IXYS Semiconductor GmbH
Edisonstr. 15, D-68623 Lampertheim
Phone: +49-6206-503-0, Fax: +49-6206-503627

IXYS reserves the right to change limits, test conditions, and dimensions.

IXYS Corporation
3540 Bassett Street, Santa Clara CA 95054
Phone: 408-982-0700, Fax: 408-496-0670

IXYS Semiconductor GmbH
Edisonstr. 15, D-68623 Lampertheim
Phone: +49-6206-503-0, Fax: +49-6206-503627