

**PACKAGE DIMENSIONS**

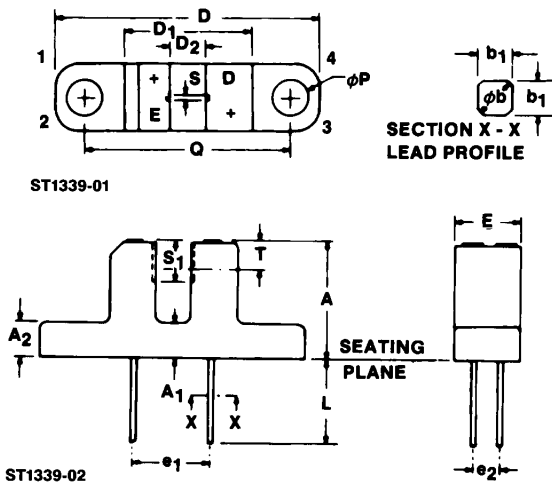

SYMBOL	MILLIMETERS		INCHES		NOTES
	MIN.	MAX.	MIN.	MAX.	
A	10.7	11.0	.422	.433	
A <sub>1</sub>	3.0	3.2	.119	.125	
A <sub>2</sub>	3.0	3.2	.119	.125	
φb	.600	.750	.024	.030	2
b <sub>1</sub>	.50 NOM.		.020 NOM.		2
D	24.3	24.7	.957	.972	
D <sub>1</sub>	11.6	12.0	.457	.472	
D <sub>2</sub>	3.0	3.3	.119	.129	
e <sub>1</sub>	6.9	7.5	.272	.295	
e <sub>2</sub>	2.3	2.8	.091	.110	
E	6.15	6.35	.243	.249	
L	8.00		.315		
φp	3.2	3.4	.126	.133	
Q	18.9	19.2	.745	.755	
S	.85	1.0	.034	.039	
S <sub>1</sub>	3.45	3.75	.136	.147	
T	2.6 NOM.		.103 NOM.		3

**NOTES:**

1. INCH DIMENSIONS ARE DERIVED FROM MILLIMETERS.
2. FOUR LEADS. LEAD CROSS SECTION IS CONTROLLED BETWEEN 1.27mm (.050") FROM SEATING PLANE AND THE END OF THE LEADS.
3. THE SENSING AREA IS DEFINED BY THE "S" DIMENSION AND BY DIMENSION "T" ±0.75mm (±.030 INCH).

**PACKAGE OUTLINE**

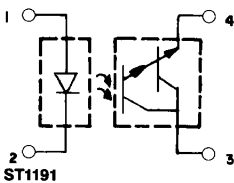

**DESCRIPTION**

The H21B Slotted Optical Switch is a gallium arsenide light emitting diode coupled to a silicon photodarlington in a plastic housing. The packaging system is designed to optimize the mechanical resolution, coupling efficiency, ambient light rejection, cost and reliability. The gap in the housing provides a means of interrupting the signal with an opaque material, switching the output from an "ON" to an "OFF" state.

**FEATURES**

- Opaque housing
- Low cost
- .035" apertures
- High I<sub>C(ON)</sub>



## SLOTTED OPTICAL SWITCH

<b>ABSOLUTE MAXIMUM RATINGS</b> ( $T_A = 25^\circ\text{C}$ Unless Otherwise Specified)	
Storage Temperature .....	$-55^\circ\text{C}$ to $+100^\circ\text{C}$
Operating Temperature .....	$-55^\circ\text{C}$ to $+100^\circ\text{C}$
Soldering:	
Lead Temperature (Iron) .....	$240^\circ\text{C}$ for 5 sec. <sup>(3,4,5)</sup>
Lead Temperature (Flow) .....	$260^\circ\text{C}$ for 10 sec. <sup>(3,4)</sup>
<b>INPUT DIODE</b>	
Continuous Forward Current .....	60 mA
Reverse Voltage .....	6.0 Volts
Power Dissipation .....	100 mW <sup>(1)</sup>
<b>OUTPUT DARLINGTON</b>	
Collector-Emitter Voltage .....	55 Volts
Emitter-Collector Voltage .....	7 Volts
Power Dissipation .....	150 mW <sup>(2)</sup>

<b>ELECTRICAL CHARACTERISTICS</b> ( $T_A = 25^\circ\text{C}$ Unless Otherwise Specified)						
PARAMETER	SYMBOL	MIN.	TYP.	MAX.	UNITS	TEST CONDITIONS
<b>INPUT DIODE</b>						
Forward Voltage	$V_F$	—		1.7	V	$I_F = 60\text{ mA}$
Reverse Breakdown Voltage	$V_R$	6.0		—	V	$I_R = 10\mu\text{A}$
Reverse Leakage Current	$I_R$	—		1.0	$\mu\text{A}$	$V_R = 3\text{ V}$
<b>OUTPUT DARLINGTON</b>						
Emitter-Collector Breakdown	$BV_{ECO}$	7.0		—	V	$I_E = 100\mu\text{A}, E_e = 0$
Collector-Emitter Breakdown	$BV_{CEO}$	55		—	V	$I_C = 1\text{ mA}, E_e = 0$
Collector-Emitter Leakage	$I_{CEO}$	—		100	nA	$V_{CE} = 45\text{ V}, E_e = 0$
<b>COUPLED</b>						
On-State Collector Current	$I_{C(ON)}$		See page 3.		mA	
Saturation Voltage	$V_{CE(SAT)}$		See page 3.		V	
Turn-On Time	$t_{on}$		See page 3.		$\mu\text{S}$	
Turn-Off Time	$t_{off}$		See page 3.		$\mu\text{S}$	

<b>NOTES</b>
<ol style="list-style-type: none"> <li>Derate power dissipation linearly <math>1.33\text{ mW}/^\circ\text{C}</math> above <math>25^\circ\text{C}</math>.</li> <li>Derate power dissipation linearly <math>2.00\text{ mW}/^\circ\text{C}</math> above <math>25^\circ\text{C}</math>.</li> <li>RMA flux is recommended.</li> <li>Methanol or Isopropyl alcohols are recommended as cleaning agents.</li> <li>Soldering iron tip <math>1/16"</math> (1.6 mm) from housing.</li> </ol>



## SLOTTED OPTICAL SWITCH

<b><math>I_{C(ON)}</math>, <math>V_{CE(SAT)}</math>, <math>t_{ON}</math> AND <math>t_{OFF}</math></b>						
PARAMETER	SYMBOL	MIN.	TYP.	MAX.	UNITS	TEST CONDITIONS
<b>ON-STATE COLLECTOR CURRENT</b>						
H21B4	$I_{C(ON)}$	0.5	—	—	mA	$I_f = 2\text{mA}$ , $V_{CE} = 1.5\text{V}$
H21B5	$I_{C(ON)}$	1.0	—	—	mA	$I_f = 2\text{mA}$ , $V_{CE} = 1.5\text{V}$
H21B6	$I_{C(ON)}$	2.0	—	—	mA	$I_f = 2\text{mA}$ , $V_{CE} = 1.5\text{V}$
H21B4	$I_{C(ON)}$	2.5	—	—	mA	$I_f = 5\text{mA}$ , $V_{CE} = 1.5\text{V}$
H21B5	$I_{C(ON)}$	5.0	—	—	mA	$I_f = 5\text{mA}$ , $V_{CE} = 1.5\text{V}$
H21B6	$I_{C(ON)}$	10	—	—	mA	$I_f = 5\text{mA}$ , $V_{CE} = 1.5\text{V}$
H21B4	$I_{C(ON)}$	7.5	—	—	mA	$I_f = 10\text{mA}$ , $V_{CE} = 1.5\text{V}$
H21B5	$I_{C(ON)}$	14	—	—	mA	$I_f = 10\text{mA}$ , $V_{CE} = 1.5\text{V}$
H21B6	$I_{C(ON)}$	25	—	—	mA	$I_f = 10\text{mA}$ , $V_{CE} = 1.5\text{V}$
<b>SATURATION VOLTAGE</b>						
H21B4	$V_{CE(SAT)}$	—	—	1.0	V	$I_f = 10\text{mA}$ , $I_C = 1.8\text{mA}$
H21B5	$V_{CE(SAT)}$	—	—	1.0	V	$I_f = 10\text{mA}$ , $I_C = 1.8\text{mA}$
H21B6	$V_{CE(SAT)}$	—	—	1.0	V	$I_f = 10\text{mA}$ , $I_C = 1.8\text{mA}$
H21B5	$V_{CE(SAT)}$	—	—	1.5	V	$I_f = 60\text{mA}$ , $I_C = 50\text{mA}$
H21B6	$V_{CE(SAT)}$	—	—	1.5	V	$I_f = 60\text{mA}$ , $I_C = 50\text{mA}$
<b>Turn-On Time</b>						
H21B4, H21B5, H21B6	$t_{ON}$	—	45	—	$\mu\text{S}$	$V_{CC} = 5\text{V}$ , $I_f = 10\text{mA}$ , $R_L = 750\Omega$
H21B4, H21B5, H21B6	$t_{ON}$	—	7	—	$\mu\text{S}$	$V_{CC} = 5\text{V}$ , $I_f = 60\text{mA}$ , $R_L = 75\Omega$
<b>Turn-Off Time</b>						
H21B4, H21B5, H21B6	$t_{OFF}$	—	250	—	$\mu\text{S}$	$V_{CC} = 5\text{V}$ , $I_f = 10\text{mA}$ , $R_L = 750\Omega$
H21B4, H21B5, H21B6	$t_{OFF}$	—	45	—	$\mu\text{S}$	$V_{CC} = 5\text{V}$ , $I_f = 60\text{mA}$ , $R_L = 75\Omega$

**TYPICAL CHARACTERISTICS**

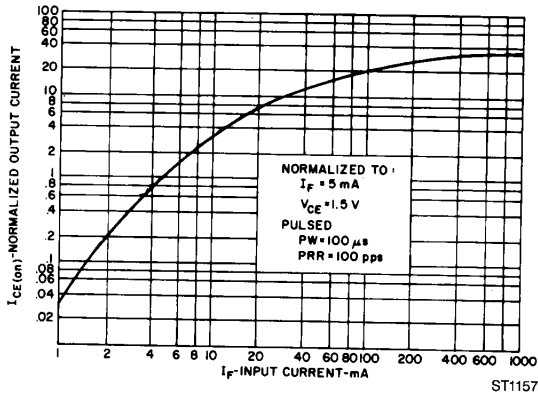

Fig. 1. Output Current vs. Input Current

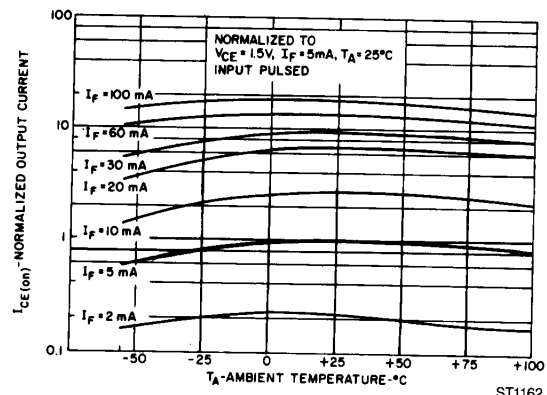

Fig. 2. Output Current vs. Temperature

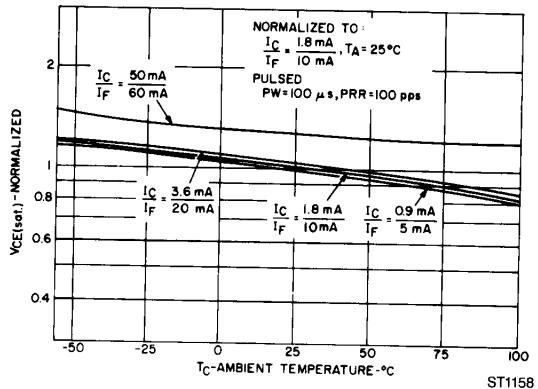

Fig. 3.  $V_{CE(sat)}$  vs. Temperature

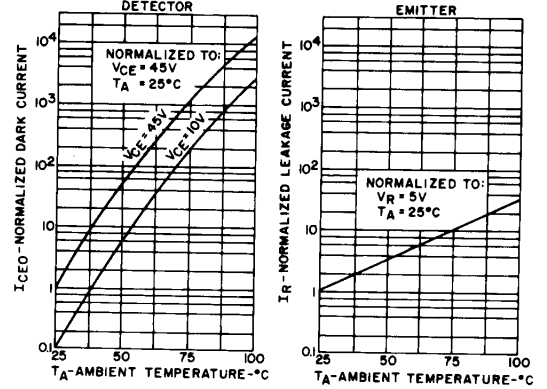

Fig. 4. Leakage Currents vs. Temperature

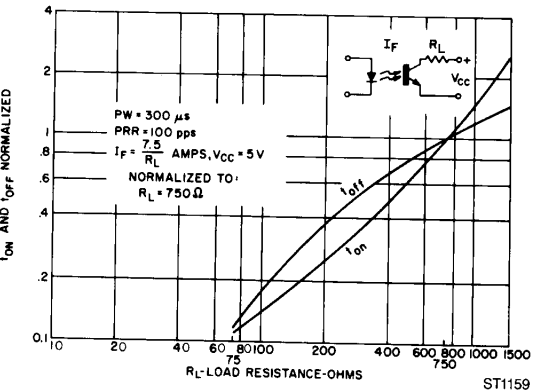

Fig. 5. Switching Speed vs.  $R_L$

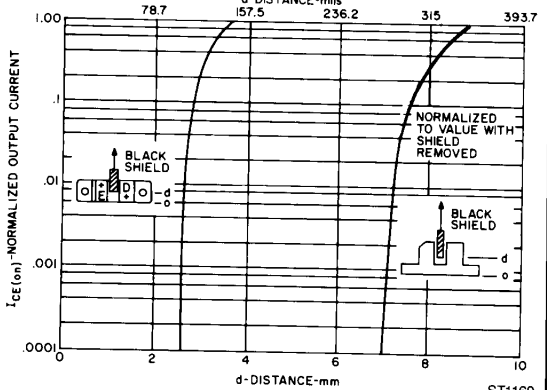

Fig. 6. Output Current vs. Shield Distance