

FD1000FX-90

HIGH POWER, HIGH FREQUENCY,
PRESS PACK TYPE

FD1000FX-90



- IF(AV) Average forward current 800A
- VRRM Repetitive peak reverse voltage 4500V
- QRR Reverse recovery charge 2000 μ C
- Press pack type

OUTLINE DRAWING

Dimensions in mm

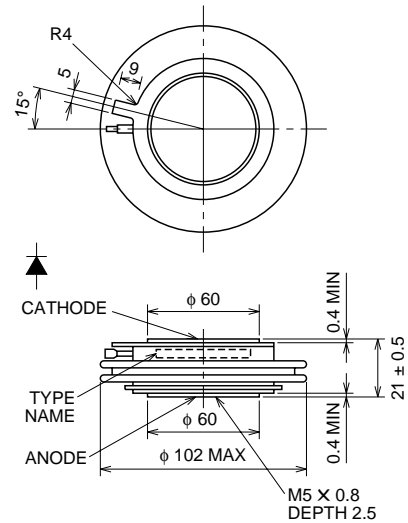

APPLICATION

High-power inverters, Fly-wheel diodes in DC choppers, Power supplies as high frequency rectifiers

MAXIMUM RATINGS

Symbol	Parameter	Voltage class		Unit
		90		
VRRM	Repetitive peak reverse voltage	4500		V
VRSM	Non-repetitive peak reverse voltage	4500		V
VR(DC)	DC reverse voltage	3600		V
VLTD5	Long term DC stability	3000		V

Symbol	Parameter	Conditions	Ratings	Unit
IF(RMS)	RMS forward current		1250	A
IF(AV)	Average forward current	f = 60Hz, sine wave $\theta = 180^\circ$, $T_f = 77^\circ\text{C}$	800	A
IFSM	Surge forward current	One half cycle at 60Hz, non-repetitive	20	kA
I^2t	Current-squared, time integration	One cycle at 60Hz	1.7×10^6	A ² s
T_j	Junction temperature		-40 ~ +125	$^\circ\text{C}$
T_{stg}	Storage temperature		-40 ~ +150	$^\circ\text{C}$
—	Mounting force required	Recommended value 39	26.5 ~ 43.0	kN
—	Weight	Standard value	700	g

ELECTRICAL CHARACTERISTICS

Symbol	Parameter	Test conditions	Limits			Unit
			Min	Typ	Max	
IRRM	Repetitive peak reverse current	$T_j = 125^\circ\text{C}$, VRRM Applied	—	—	150	mA
VFM	Forward voltage	$T_j = 125^\circ\text{C}$, IFM = 2500A, Instantaneous measurement	—	—	3.5	V
QRR	Reverse recovery charge	IFM = 800A, $di/dt = -30\text{A}/\mu\text{s}$, $V_R = 150\text{V}$, $T_j = 125^\circ\text{C}$	—	—	2000	μC
Rth(j-f)	Thermal resistance	Junction to fin	—	—	0.017	$^\circ\text{C}/\text{W}$

FD1000FX-90

HIGH POWER, HIGH FREQUENCY,
PRESS PACK TYPE

PERFORMANCE CURVES

MAXIMUM FORWARD CHARACTERISTICS

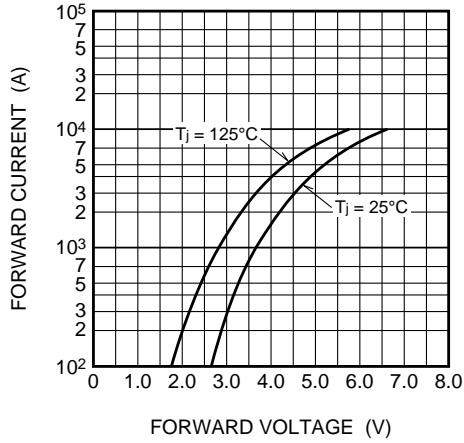

RATED SURGE FORWARD CURRENT

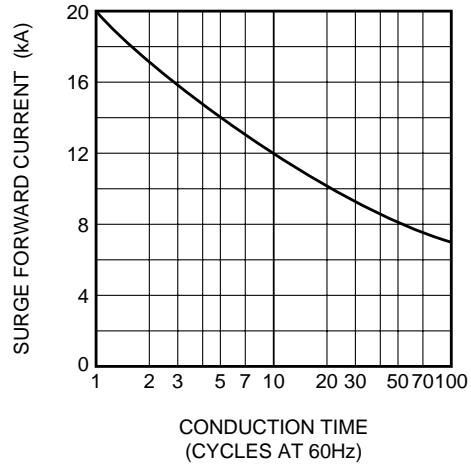

MAXIMUM THERMAL IMPEDANCE CHARACTERISTIC (JUNCTION TO FIN)

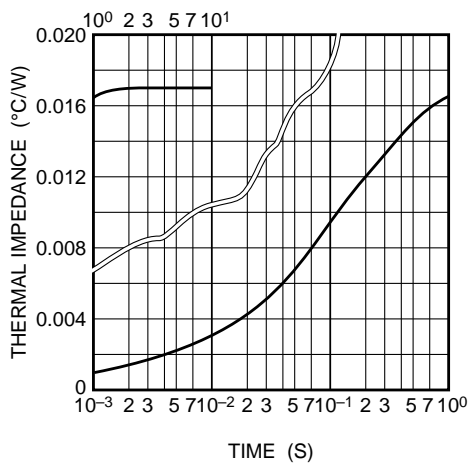

MAXIMUM POWER DISSIPATION CHARACTERISTICS

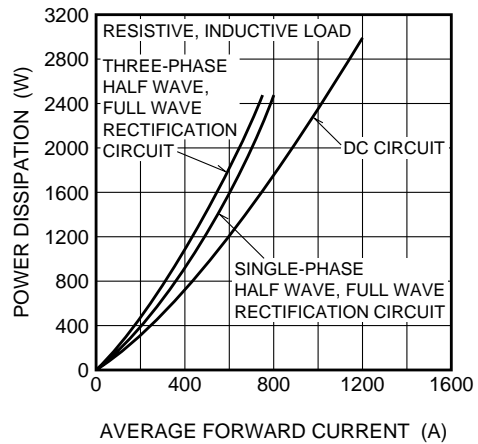

ALLOWABLE FIN TEMPERATURE VS. AVERAGE FORWARD CURRENT

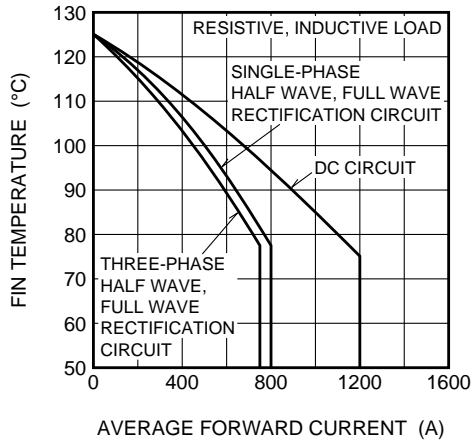

REVERSE RECOVERY CHARGE, REVERSE RECOVERY TIME VS. JUNCTION TEMPERATURE

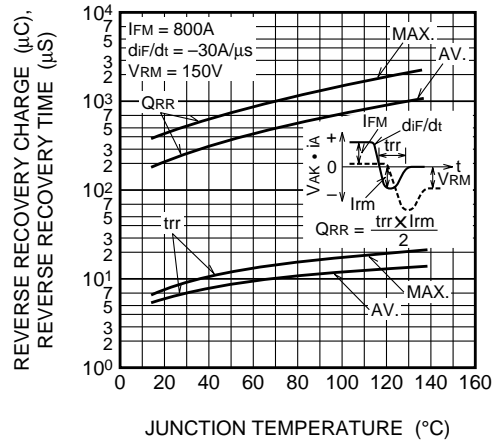

FD1000FX-90

HIGH POWER, HIGH FREQUENCY,
PRESS PACK TYPE

**REVERSE RECOVERY CHARGE,
REVERSE RECOVERY TIME VS.
FORWARD CURRENT**

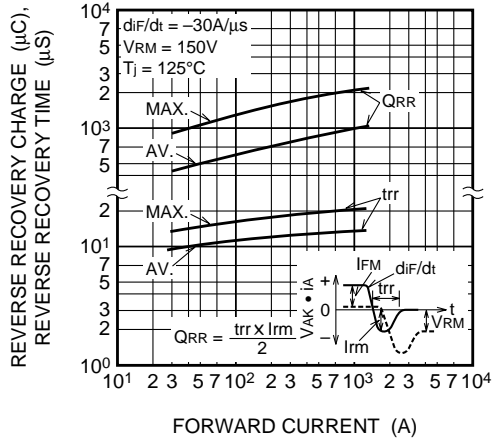

**REVERSE RECOVERY CHARGE,
REVERSE RECOVERY TIME VS. RATE
OF DECREASE OF REVERSE CURRENT**

