

NUD3112

Integrated Relay, Inductive Load Driver

This device is used to switch inductive loads such as relays, solenoids incandescent lamps, and small DC motors without the need of a free-wheeling diode. The device integrates all necessary items such as the MOSFET switch, ESD protection, and Zener clamps. It accepts logic level inputs thus allowing it to be driven by a large variety of devices including logic gates, inverters, and microcontrollers.

Features

- Provides a Robust Driver Interface Between D.C. Relay Coil and Sensitive Logic Circuits
- Optimized to Switch Relays of 12 V Rail
- Capable of Driving Relay Coils Rated up to 6.0 W at 12 V
- Internal Zener Eliminates the Need of Free-Wheeling Diode
- Internal Zener Clamp Routes Induced Current to Ground for Quieter Systems Operation
- Low $V_{DS(ON)}$ Reduces System Current Drain
- Pb-Free Package is Available

Typical Applications

- Telecom: Line Cards, Modems, Answering Machines, FAX
- Computers and Office: Photocopiers, Printers, Desktop Computers
- Consumer: TVs and VCRs, Stereo Receivers, CD Players, Cassette Recorders
- Industrial: Small Appliances, Security Systems, Automated Test Equipment, Garage Door Openers

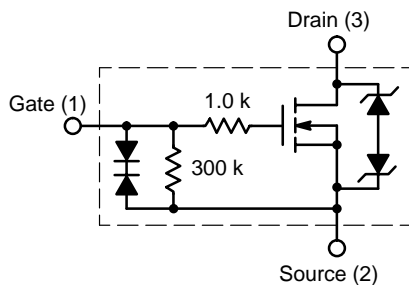

CASE 318

INTERNAL CIRCUIT DIAGRAMS

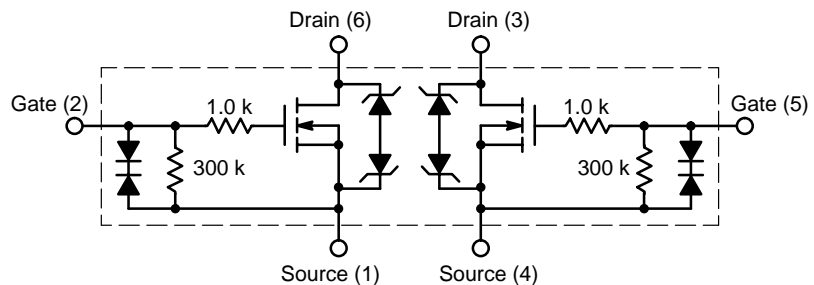

CASE 318F



ON Semiconductor®

<http://onsemi.com>

Relay, Inductive Load Driver Silicon SMALLBLOCK™ 0.5 Ampere, 16 V Clamp

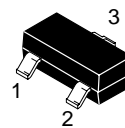

**SOT-23
CASE 318
STYLE 21**

MARKING DIAGRAMS

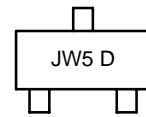

JW5 = Specific Device Code
D = Date Code

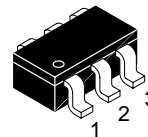

**SC-74
CASE 318F
STYLE 7**

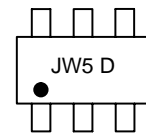

JW5 = Specific Device Code
D = Date Code

ORDERING INFORMATION

Device	Package	Shipping†
NUD3112LT1	SOT-23	3000/Tape & Reel
NUD3112LT1G	SOT-23 (Pb-Free)	3000/Tape & Reel
NUD3112DMT1	SC-74	3000/Tape & Reel

†For information on tape and reel specifications, including part orientation and tape sizes, please refer to our Tape and Reel Packaging Specification Brochure, BRD8011/D.

NUD3112

MAXIMUM RATINGS (T_J = 25°C unless otherwise specified)

Symbol	Rating	Value	Unit	
V _{DSS}	Drain to Source Voltage – Continuous	14	V _{dc}	
V _{GS}	Gate to Source Voltage – Continuous	6	V _{dc}	
I _D	Drain Current – Continuous	500	mA	
E _z	Single Pulse Drain-to-Source Avalanche Energy (T _{Jinitial} = 25°C)	50	mJ	
T _J	Junction Temperature	150	°C	
T _A	Operating Ambient Temperature	-40 to 85	°C	
T _{stg}	Storage Temperature Range	-65 to +150	°C	
P _D	Total Power Dissipation (Note 1) Derating Above 25°C	SOT-23	225	mW
			1.8	mW/°C
P _D	Total Power Dissipation (Note 1) Derating Above 25°C	SC-74	380	mW
			3.0	mW/°C
R _{θJA}	Thermal Resistance Junction-to-Ambient (Note 1)	SOT-23	556	°C/W
		SC-74	329	
ESD	Human Body Model (HBM) According to EIA/JESD22/A114	2000	V	

1. Mounted onto minimum pad board.

TYPICAL ELECTRICAL CHARACTERISTICS (T_A = 25°C unless otherwise noted)

Symbol	Characteristic	Min	Typ	Max	Unit
OFF CHARACTERISTICS					
V _{BRDSS}	Drain to Source Sustaining Voltage (Internally Clamped) (I _D = 10 mA)	14	16	17	V
B _{VGS0}	I _g = 1.0 mA	–	–	8	V
I _{DSS}	Drain to Source Leakage Current (V _{DS} = 12 V, V _{GS} = 0 V, T _A = 25°C) (V _{DS} = 12 V, V _{GS} = 0 V, T _A = 85°C)	–	–	20	μA
		–	–	40	
I _{GSS}	Gate Body Leakage Current (V _{GS} = 3.0 V, V _{DS} = 0 V) (V _{GS} = 5.0 V, V _{DS} = 0 V)	–	–	35	μA
		–	–	65	
ON CHARACTERISTICS					
V _{GS(th)}	Gate Threshold Voltage (V _{GS} = V _{DS} , I _D = 1.0 mA) (V _{GS} = V _{DS} , I _D = 1.0 mA, T _A = 85°C)	0.8	1.2	1.4	V
		0.8	–	1.4	
R _{DS(on)}	Drain to Source On-Resistance (I _D = 250 mA, V _{GS} = 3.0 V) (I _D = 500 mA, V _{GS} = 3.0 V) (I _D = 500 mA, V _{GS} = 5.0 V) (I _D = 500 mA, V _{GS} = 3.0 V, T _A = 85°C) (I _D = 500 mA, V _{GS} = 5.0 V, T _A = 85°C)	–	–	1.2	Ω
		–	–	1.3	
		–	–	0.9	
		–	–	1.3	
		–	–	0.9	
I _{DS(on)}	Output Continuous Current (V _{DS} = 0.25 V, V _{GS} = 3.0 V) (V _{DS} = 0.25 V, V _{GS} = 3.0 V, T _A = 85°C)	300	400	–	mA
		200	–	–	
g _{FS}	Forward Transconductance (V _{OUT} = 12.0 V, I _{OUT} = 0.25 A)	350	490	–	mmhos

NUD3112

TYPICAL ELECTRICAL CHARACTERISTICS ($T_A = 25^\circ\text{C}$ unless otherwise noted)

Symbol	Characteristic	Min	Typ	Max	Unit
--------	----------------	-----	-----	-----	------

DYNAMIC CHARACTERISTICS

C_{iss}	Input Capacitance ($V_{DS} = 12\text{ V}$, $V_{GS} = 0\text{ V}$, $f = 10\text{ kHz}$)	-	23	-	pF
C_{oss}	Output Capacitance ($V_{DS} = 12\text{ V}$, $V_{GS} = 0\text{ V}$, $f = 10\text{ kHz}$)	-	30	-	pF
C_{rss}	Transfer Capacitance ($V_{DS} = 12.0\text{ V}$, $V_{GS} = 0\text{ V}$, $f = 10\text{ kHz}$)	-	7	-	pF

SWITCHING CHARACTERISTICS

Symbol	Characteristic	Min	Typ	Max	Units
t_{PHL} t_{PLH}	Propagation Delay Times: High to Low Propagation Delay; Figure 1 ($V_{DS} = 12\text{ V}$, $V_{GS} = 5.0\text{ V}$) Low to High Propagation Delay; Figure 1 ($V_{DS} = 12\text{ V}$, $V_{GS} = 5.0\text{ V}$)	-	21 91	-	nS
t_f t_r	Transition Times: Fall Time; Figure 1 ($V_{DS} = 12\text{ V}$, $V_{GS} = 5.0\text{ V}$) Rise Time; Figure 1 ($V_{DS} = 12\text{ V}$, $V_{GS} = 5.0\text{ V}$)	-	36 61	-	nS

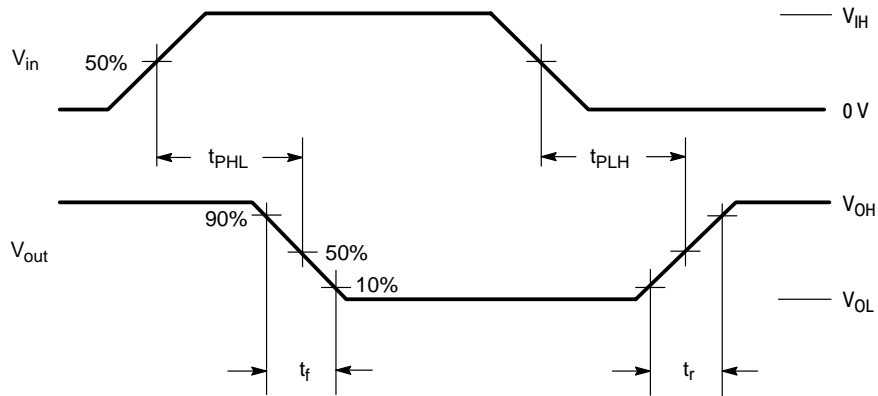

Figure 1. Switching Waveforms

NUD3112

TYPICAL PERFORMANCE CURVES ($T_J = 25^\circ\text{C}$ unless otherwise specified)

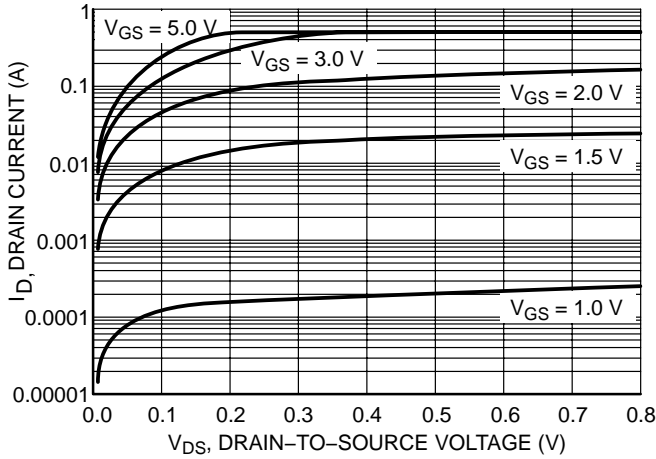

Figure 2. Output Characteristics

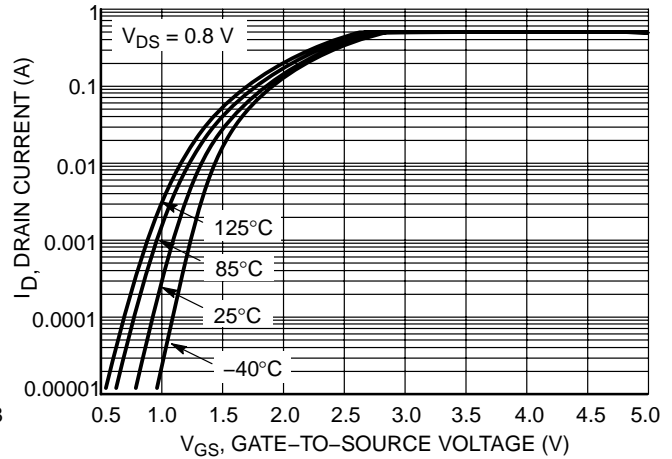

Figure 3. Transfer Function

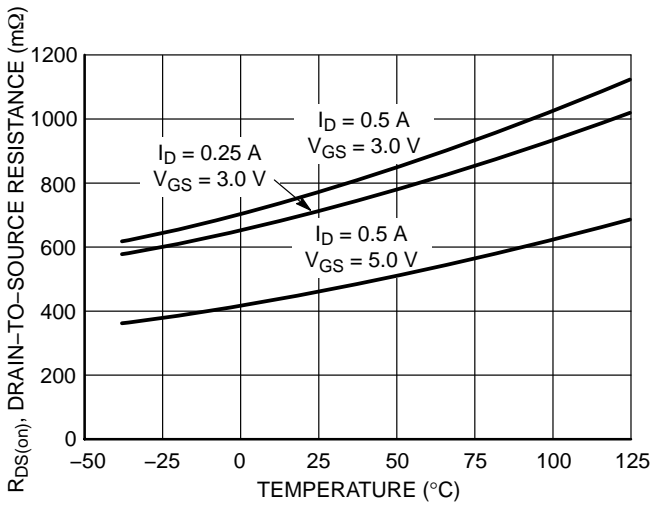

Figure 4. On-Resistance Variation vs. Temperature

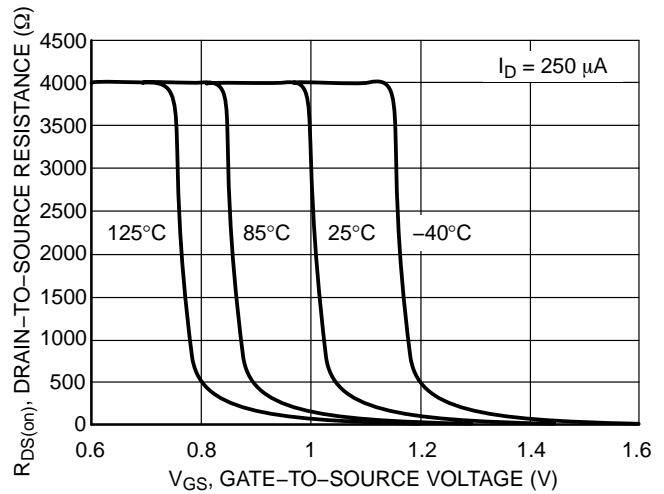

Figure 5. $R_{DS(ON)}$ Variation vs. Gate-to-Source Voltage

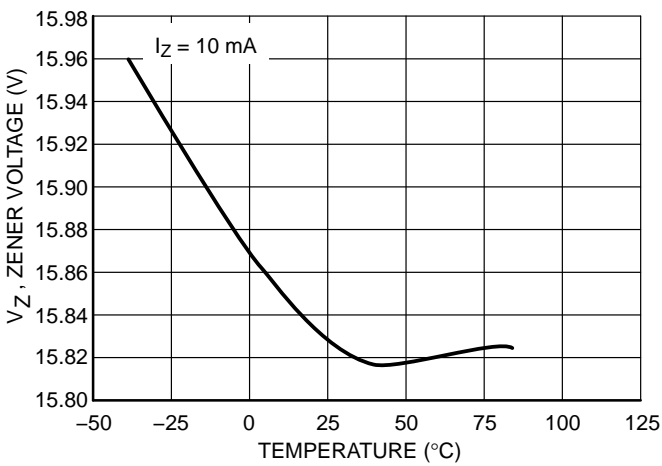

Figure 6. Zener Voltage vs. Temperature

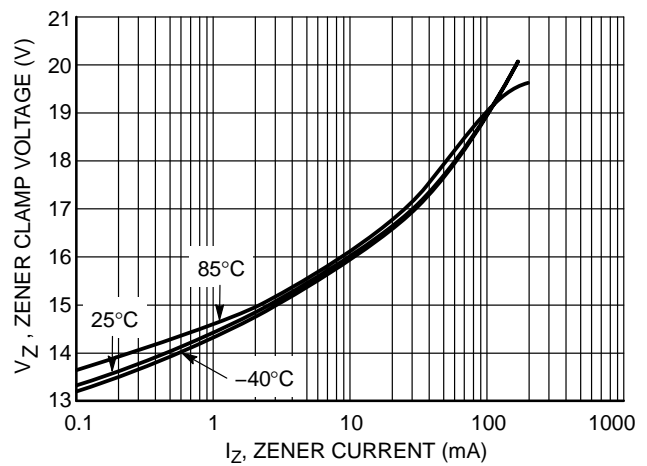

Figure 7. Zener Clamp Voltage vs. Zener Current

NUD3112

TYPICAL PERFORMANCE CURVES ($T_J = 25^\circ\text{C}$ unless otherwise specified)

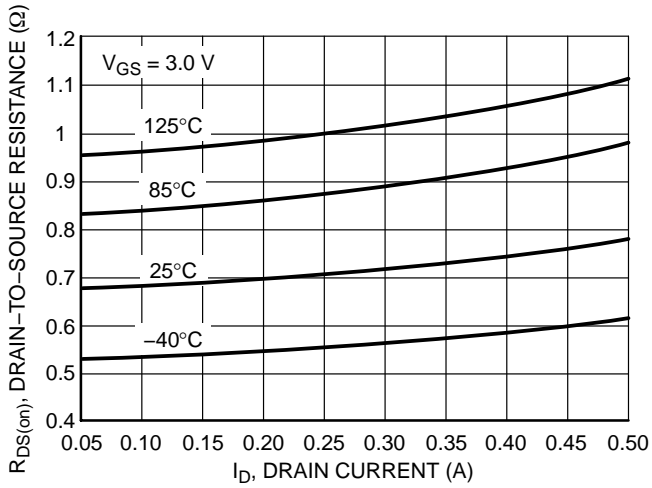

Figure 8. On-Resistance vs. Drain Current and Temperature

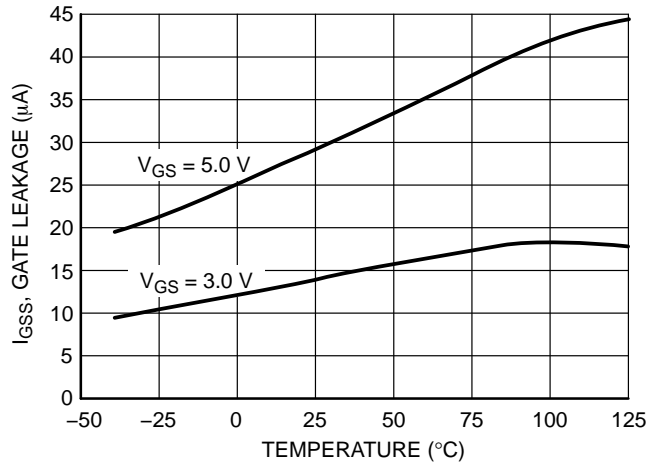

Figure 9. Gate Leakage vs. Temperature

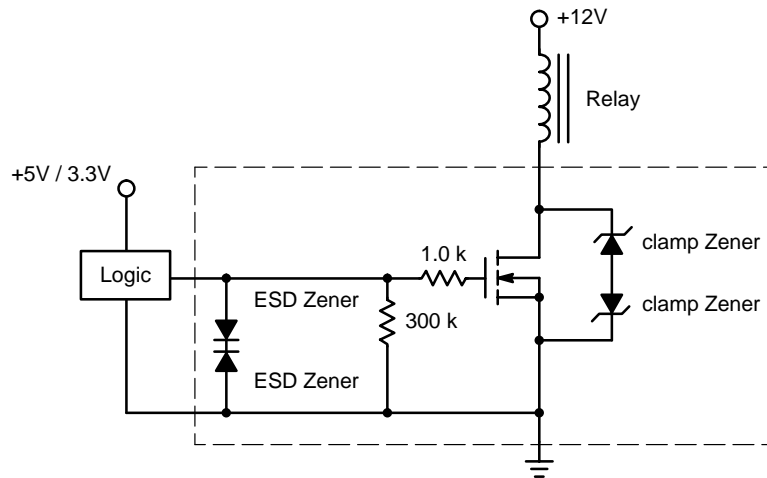

Figure 10. Typical Application Circuit

NUD3112

PACKAGE DIMENSIONS

SOT-23 (TO-236)
CASE 318-08
ISSUE AH

NOTES:

1. DIMENSIONING AND TOLERANCING PER ANSI Y14.5M, 1982.
2. CONTROLLING DIMENSION: INCH.
3. MAXIMUM LEAD THICKNESS INCLUDES LEAD FINISH THICKNESS. MINIMUM LEAD THICKNESS IS THE MINIMUM THICKNESS OF BASE MATERIAL.
4. 318-03 AND -07 OBSOLETE, NEW STANDARD 318-08.

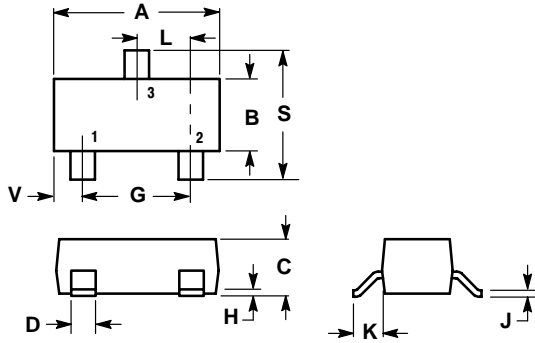

DIM	INCHES		MILLIMETERS	
	MIN	MAX	MIN	MAX
A	0.1102	0.1197	2.80	3.04
B	0.0472	0.0551	1.20	1.40
C	0.0350	0.0440	0.89	1.11
D	0.0150	0.0200	0.37	0.50
G	0.0701	0.0807	1.78	2.04
H	0.0005	0.0040	0.013	0.100
J	0.0034	0.0070	0.085	0.177
K	0.0140	0.0285	0.35	0.69
L	0.0350	0.0401	0.89	1.02
S	0.0830	0.1039	2.10	2.64
V	0.0177	0.0236	0.45	0.60

STYLE 21:

- PIN 1. GATE
- SOURCE
- DRAIN

SOLDERING FOOTPRINT*

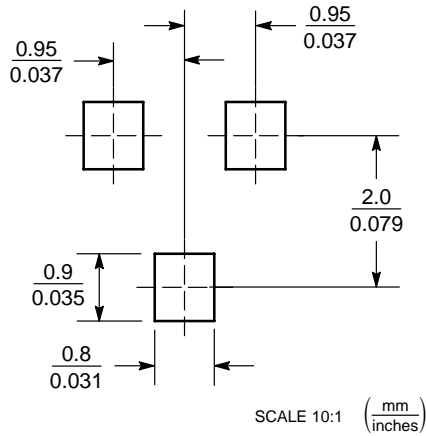

*For additional information on our Pb-Free strategy and soldering details, please download the ON Semiconductor Soldering and Mounting Techniques Reference Manual, SOLDERRM/D.

NUD3112

PACKAGE DIMENSIONS

SC-74
CASE 318F-05
ISSUE K

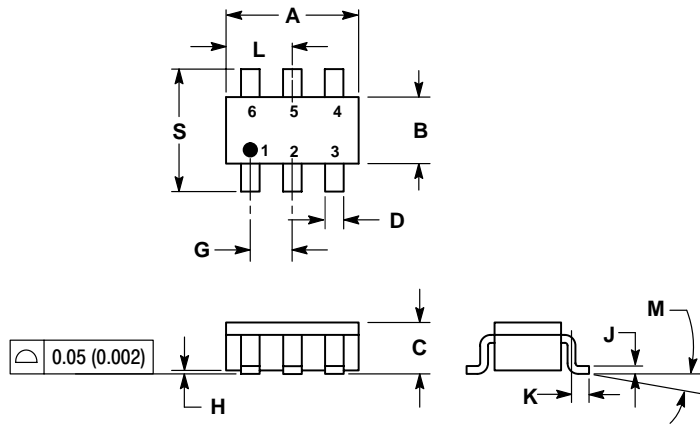

NOTES:

1. DIMENSIONING AND TOLERANCING PER ANSI Y14.5M, 1982.
2. CONTROLLING DIMENSION: INCH.
3. MAXIMUM LEAD THICKNESS INCLUDES LEAD FINISH THICKNESS. MINIMUM LEAD THICKNESS IS THE MINIMUM THICKNESS OF BASE MATERIAL.
4. 318F-01, -02, -03 OBSOLETE. NEW STANDARD 318F-04.

DIM	INCHES		MILLIMETERS	
	MIN	MAX	MIN	MAX
A	0.1142	0.1220	2.90	3.10
B	0.0512	0.0669	1.30	1.70
C	0.0354	0.0433	0.90	1.10
D	0.0098	0.0197	0.25	0.50
G	0.0335	0.0413	0.85	1.05
H	0.0005	0.0040	0.013	0.100
J	0.0040	0.0102	0.10	0.26
K	0.0079	0.0236	0.20	0.60
L	0.0493	0.0649	1.25	1.65
M	0°	10°	0°	10°
S	0.0985	0.1181	2.50	3.00

STYLE 7:

- PIN 1. SOURCE 1
- GATE 1
- DRAIN 2
- SOURCE 2
- GATE 2
- DRAIN 1

RECOMMENDED FOOTPRINT

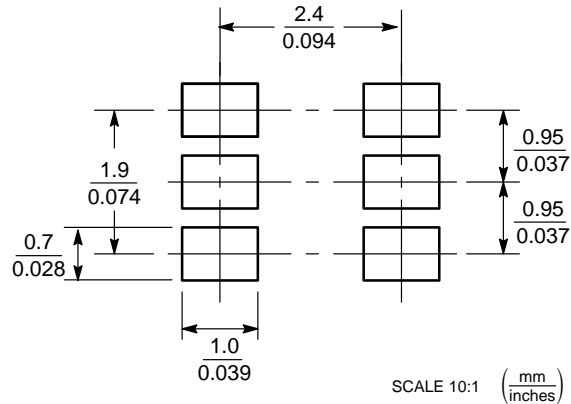

SMALLBLOCK is a trademark of Semiconductor Components Industries, LLC (SCILLC).

ON Semiconductor and  are registered trademarks of Semiconductor Components Industries, LLC (SCILLC). SCILLC reserves the right to make changes without further notice to any products herein. SCILLC makes no warranty, representation or guarantee regarding the suitability of its products for any particular purpose, nor does SCILLC assume any liability arising out of the application or use of any product or circuit, and specifically disclaims any and all liability, including without limitation special, consequential or incidental damages. "Typical" parameters which may be provided in SCILLC data sheets and/or specifications can and do vary in different applications and actual performance may vary over time. All operating parameters, including "Typicals" must be validated for each customer application by customer's technical experts. SCILLC does not convey any license under its patent rights nor the rights of others. SCILLC products are not designed, intended, or authorized for use as components in systems intended for surgical implant into the body, or other applications intended to support or sustain life, or for any other application in which the failure of the SCILLC product could create a situation where personal injury or death may occur. Should Buyer purchase or use SCILLC products for any such unintended or unauthorized application, Buyer shall indemnify and hold SCILLC and its officers, employees, subsidiaries, affiliates, and distributors harmless against all claims, costs, damages, and expenses, and reasonable attorney fees arising out of, directly or indirectly, any claim of personal injury or death associated with such unintended or unauthorized use, even if such claim alleges that SCILLC was negligent regarding the design or manufacture of the part. SCILLC is an Equal Opportunity/Affirmative Action Employer. This literature is subject to all applicable copyright laws and is not for resale in any manner.

PUBLICATION ORDERING INFORMATION

LITERATURE FULFILLMENT:

Literature Distribution Center for ON Semiconductor
P.O. Box 61312, Phoenix, Arizona 85082-1312 USA
Phone: 480-829-7710 or 800-344-3860 Toll Free USA/Canada
Fax: 480-829-7709 or 800-344-3867 Toll Free USA/Canada
Email: orderlit@onsemi.com

N. American Technical Support: 800-282-9855 Toll Free
USA/Canada

Japan: ON Semiconductor, Japan Customer Focus Center
2-9-1 Kamimeguro, Meguro-ku, Tokyo, Japan 153-0051
Phone: 81-3-5773-3850

ON Semiconductor Website: <http://onsemi.com>

Order Literature: <http://www.onsemi.com/litorder>

For additional information, please contact your
local Sales Representative.