

SWITCHMODE II Series NPN Silicon Power Transistors

The BUX 48/BUX 48A transistors are designed for high-voltage, high-speed, power switching in inductive circuits where fall time is critical. They are particularly suited for line-operated SWITCHMODE applications such as:

- Switching Regulators
- Inverters
- Solenoid and Relay Drivers
- Motor Controls
- Deflection Circuits

Fast Turn-Off Times

60 ns Inductive Fall Time — 25°C (Typ)

120 ns Inductive Crossover Time — 25°C (Typ)

Operating Temperature Range -65 to +200°C

100°C Performance Specified for:

Reverse-Biased SOA with Inductive Loads

Switching Times with Inductive Loads

Saturation Voltage

Leakage Currents (125°C)

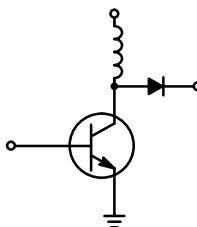

BUX48
BUX48A

15 AMPERES
NPN SILICON
POWER TRANSISTORS
400 AND 450 VOLTS

$V_{(BR)CEO}$
850-1000 VOLTS

$V_{(BR)CEX}$
175 WATTS

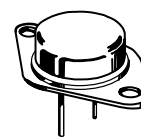

CASE 1-07
TO-204AA
(TO-3)

MAXIMUM RATINGS

Rating	Symbol	BUX48	BUX48A	Unit
Collector-Emitter Voltage	$V_{CEO(sus)}$	400	450	Vdc
Collector-Emitter Voltage ($V_{BE} = -1.5$ V)	V_{CEX}	850	1000	Vdc
Emitter Base Voltage	V_{EB}	7		Vdc
Collector Current — Continuous	I_C	15		Adc
— Peak (1)	I_{CM}	30		
— Overload	I_{OI}	60		
Base Current — Continuous	I_B	5		Adc
— Peak (1)	I_{BM}	20		
Total Power Dissipation — $T_C = 25^\circ\text{C}$	P_D	175		Watts
— $T_C = 100^\circ\text{C}$		100		
Derate above 25°C		1		W/°C
Operating and Storage Junction Temperature Range	T_J, T_{stg}	-65 to +200		°C

THERMAL CHARACTERISTICS

Characteristic	Symbol	Max	Unit
Thermal Resistance, Junction to Case	$R_{\theta JC}$	1	°C/W
Maximum Lead Temperature for Soldering Purposes: 1/8" from Case for 5 Seconds	T_L	275	°C

(1) Pulse Test: Pulse Width = 5 ms, Duty Cycle ≤ 10%.

SWITCHMODE is a trademark of Motorola, Inc.

REV 7

BUX48 BUX48A

ELECTRICAL CHARACTERISTICS (T_C = 25°C unless otherwise noted)

Characteristic	Symbol	Min	Typ	Max	Unit	
OFF CHARACTERISTICS (1)						
Collector–Emitter Sustaining Voltage (Table 1) (I _C = 200 mA, I _B = 0) L = 25 mH	BUX48 BUX48A	V _{CEO(sus)}	400 450	— —	— —	Vdc
Collector Cutoff Current (V _{CEX} = Rated Value, V _{BE(off)} = 1.5 Vdc) (V _{CEX} = Rated Value, V _{BE(off)} = 1.5 Vdc, T _C = 125°C)		I _{CEX}	— —	— —	0.2 2	mAdc
Collector Cutoff Current (V _{CE} = Rated V _{CEX} , R _{BE} = 10 Ω)	T _C = 25°C T _C = 125°C	I _{CER}	— —	— —	0.5 3	mAdc
Emitter Cutoff Current (V _{EB} = 5 Vdc, I _C = 0)		I _{EBO}	—	—	0.1	mAdc
Emitter–Base Breakdown Voltage (I _E = 50 mA – I _C = 0)		V _{(BR)EBO}	7	—	—	Vdc

SECOND BREAKDOWN

Second Breakdown Collector Current with Base Forward Biased	I _{S/b}	See Figure 12
Clamped Inductive SOA with Base Reverse Biased	RBSOA	See Figure 13

ON CHARACTERISTICS (1)

DC Current Gain (I _C = 10 Adc, V _{CE} = 5 Vdc) (I _C = 8 Adc, V _{CE} = 5 Vdc)	BUX48 BUX48A	h _{FE}	8 8	— —	— —	
Collector–Emitter Saturation Voltage (I _C = 10 Adc, I _B = 2 Adc) (I _C = 15 Adc, I _B = 3 Adc) (I _C = 10 Adc, I _B = 2 Adc, T _C = 100°C) (I _C = 8 Adc, I _B = 1.6 Adc) (I _C = 12 Adc, I _B = 2.4 Adc) (I _C = 8 Adc, I _B = 1.6 Adc, T _C = 100°C)	BUX48 BUX48A	V _{CE(sat)}	— — — — — —	— — — — — —	1.5 5 2 1.5 5 2	Vdc
Base–Emitter Saturation Voltage (I _C = 10 Adc, I _B = 2 Adc) (I _C = 10 Adc, I _B = 2 Adc, T _C = 100°C) (I _C = 8 Adc, I _B = 1.6 Adc) (I _C = 8 Adc, I _B = 1.6 Adc, T _C = 100°C)	BUX48 BUX48A	V _{BE(sat)}	— — — —	— — — —	1.6 1.6 1.6 1.6	Vdc

DYNAMIC CHARACTERISTICS

Output Capacitance (V _{CB} = 10 Vdc, I _E = 0, f _{test} = 1 MHz)	C _{ob}	—	—	350	pF
---	-----------------	---	---	-----	----

SWITCHING CHARACTERISTICS Resistive Load (Table 1)

Delay Time	I _C = 10 A, I _B = 2 A I _C = 8 A, I _B = 1.6 A Duty Cycle = 2%, V _{BE(off)} = 5 V T _p = 30 μs, V _{CC} = 300 V	BUX48 BUX48A	t _d	—	0.1	0.2	μs
Rise Time			t _r	—	0.4	0.7	
Storage Time			t _s	—	1.3	2	
Fall Time			t _f	—	0.2	0.4	

Inductive Load, Clamped (Table 1)

Storage Time	I _C = 10 A I _{B1} = 2 A	BUX48	(T _C = 25°C)	t _{sv}	—	1.3	—	μs
Fall Time				t _{fi}	—	0.06	—	
Storage Time	I _C = 8 A I _{B1} = 1.6 A	BUX48A	(T _C = 100°C)	t _{sv}	—	1.5	2.5	
Crossover Time				t _c	—	0.3	0.6	
Fall Time				t _{fi}	—	0.17	0.35	

(1) Pulse Test: Pulse Width = 300 μs, Duty Cycle ≤ 2%.

V_{cl} = 300 V, V_{BE(off)} = 5 V, L_c = 180 μH

DC CHARACTERISTICS

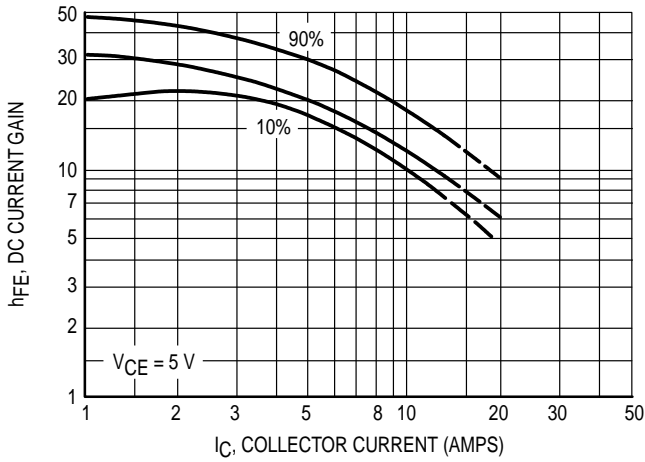

Figure 1. DC Current Gain

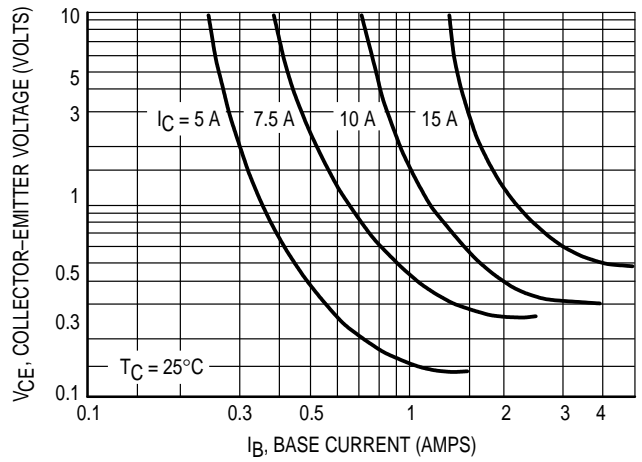

Figure 2. Collector Saturation Region

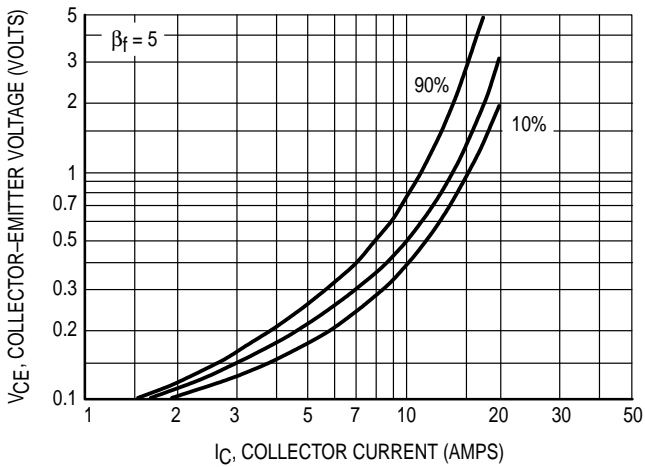

Figure 3. Collector-Emitter Saturation Voltage

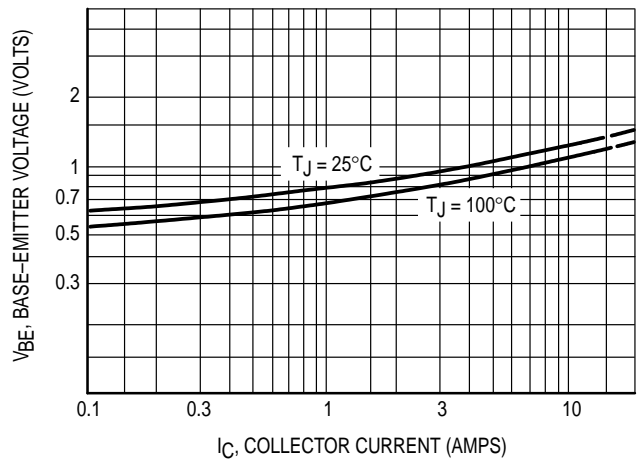

Figure 4. Base-Emitter Voltage

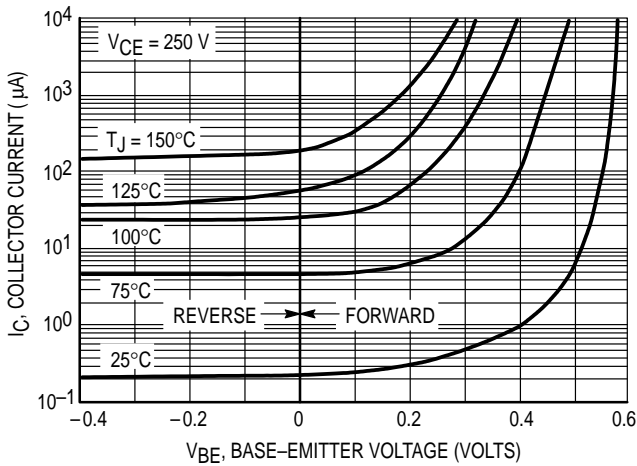

Figure 5. Collector Cutoff Region

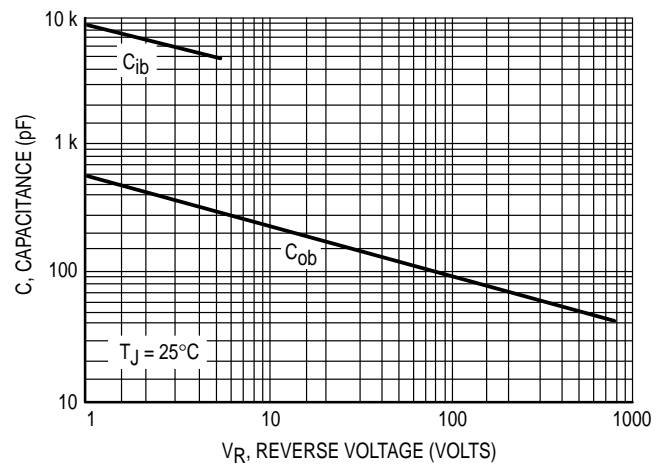

Figure 6. Capacitance

Table 1. Test Conditions for Dynamic Performance

	$V_{CE0}(sus)$	RBSOA AND INDUCTIVE SWITCHING	RESISTIVE SWITCHING
INPUT CONDITIONS	<p>PW Varied to Attain $I_C = 200\text{ mA}$</p>		<p>TURN-ON TIME</p> <p>I_{B1} adjusted to obtain the forced h_{FE} desired</p> <p>TURN-OFF TIME</p> <p>Use inductive switching driver as the input to the resistive test circuit.</p>
CIRCUIT VALUES	<p>$L_{coil} = 25\text{ mH}$, $V_{CC} = 10\text{ V}$ $R_{coil} = 0.7\ \Omega$</p>	<p>$L_{coil} = 180\ \mu\text{H}$ $R_{coil} = 0.05\ \Omega$ $V_{CC} = 20\text{ V}$</p> <p>$V_{clamp} = 300\text{ V}$ R_B ADJUSTED TO ATTAIN DESIRED I_{B1}</p>	<p>$V_{CC} = 300\text{ V}$ $R_L = 83\ \Omega$ Pulse Width = $10\ \mu\text{s}$</p>
TEST CIRCUITS	<p>INDUCTIVE TEST CIRCUIT</p> <p>SEE ABOVE FOR DETAILED CONDITIONS</p>	<p>OUTPUT WAVEFORMS</p> <p>t_1 Adjusted to Obtain I_C</p> $t_1 = \frac{L_{coil}(I_{Cpk})}{V_{CC}}$ $t_2 = \frac{L_{coil}(I_{Cpk})}{V_{Clamp}}$ <p>Test Equipment Scope — Tektronix 475 or Equivalent</p>	<p>RESISTIVE TEST CIRCUIT</p>

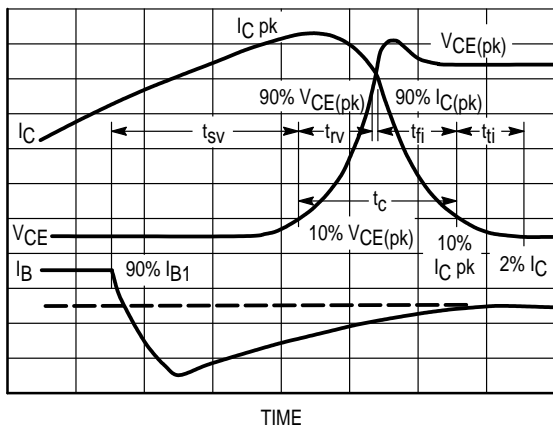

Figure 7. Inductive Switching Measurements

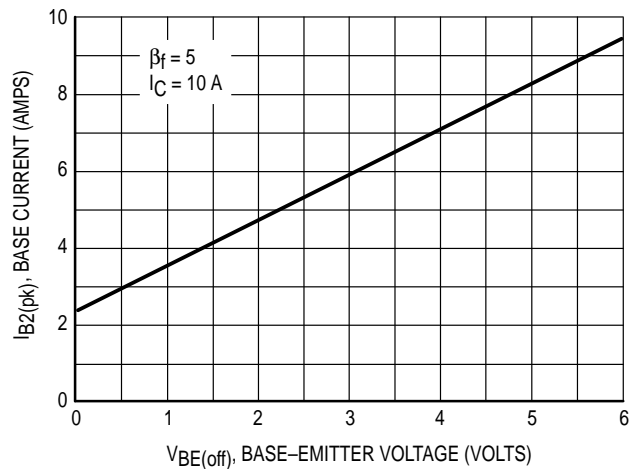

Figure 8. Peak-Reverse Current

SWITCHING TIMES NOTE

In resistive switching circuits, rise, fall, and storage times have been defined and apply to both current and voltage waveforms since they are in phase. However, for inductive loads which are common to SWITCHMODE power supplies and hammer drivers, current and voltage waveforms are not in phase. Therefore, separate measurements must be made on each waveform to determine the total switching time. For this reason, the following new terms have been defined.

- t_{SV} = Voltage Storage Time, 90% I_{B1} to 10% V_{clamp}
- t_{RV} = Voltage Rise Time, 10–90% V_{clamp}
- t_{fi} = Current Fall Time, 90–10% I_C
- t_{ti} = Current Tail, 10–2% I_C
- t_c = Crossover Time, 10% V_{clamp} to 10% I_C

An enlarged portion of the inductive switching waveforms

is shown in Figure 7 to aid in the visual identity of these terms.

For the designer, there is minimal switching loss during storage time and the predominant switching power losses occur during the crossover interval and can be obtained using the standard equation from AN-222:

$$P_{SWT} = 1/2 V_{CC} I_C (t_c) f$$

In general, $t_{RV} + t_{fi} \approx t_c$. However, at lower test currents this relationship may not be valid.

As is common with most switching transistors, resistive switching is specified at 25°C and has become a benchmark for designers. However, for designers of high frequency converter circuits, the user oriented specifications which make this a "SWITCHMODE" transistor are the inductive switching speeds (t_c and t_{SV}) which are guaranteed at 100°C.

INDUCTIVE SWITCHING

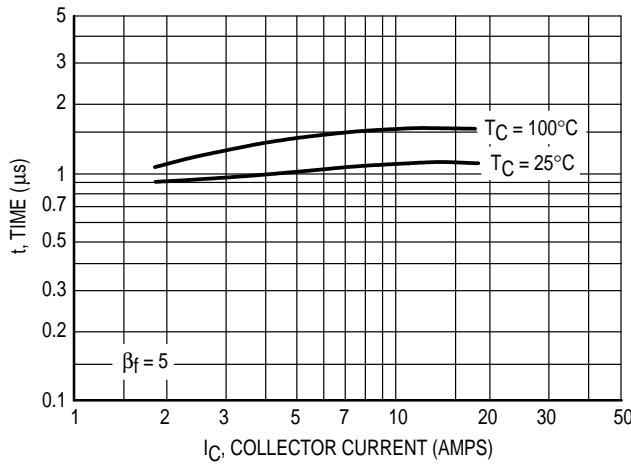

Figure 9. Storage Time, t_{SV}

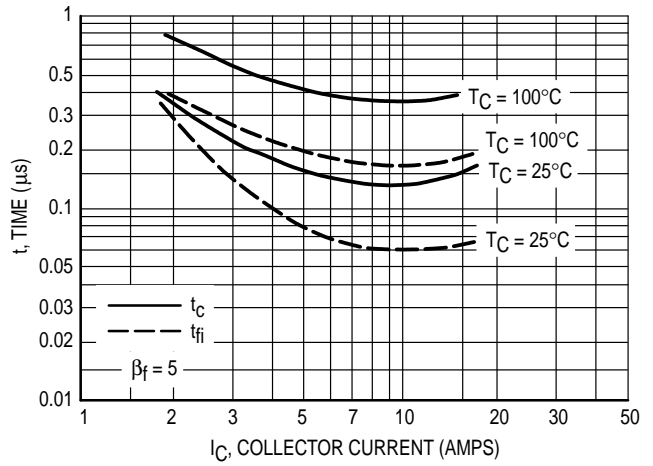

Figure 10. Crossover and Fall Times

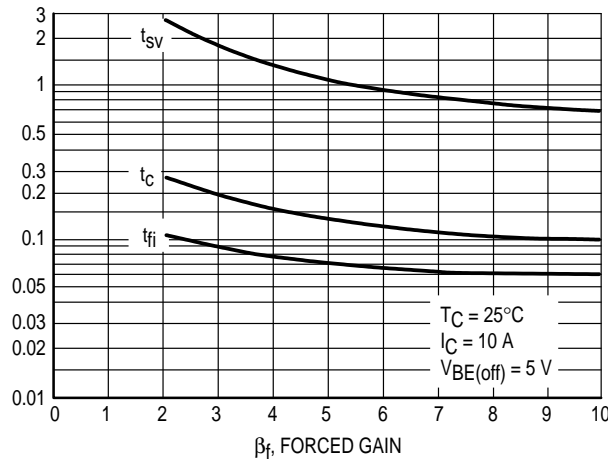

Figure 11a. Turn-Off Times versus Forced Gain

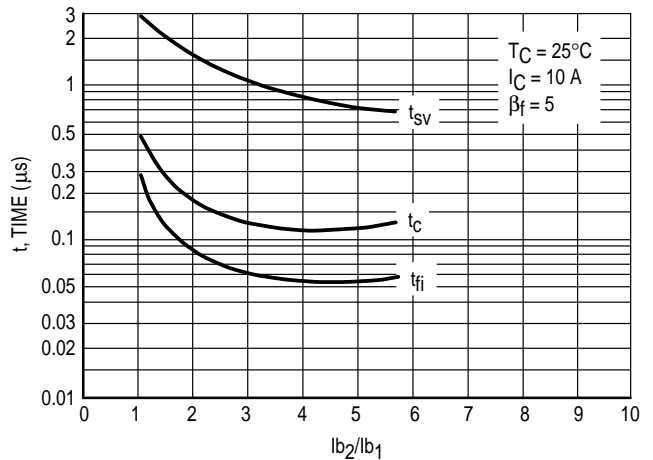

Figure 11b. Turn-Off Times versus I_{b2}/I_{b1}

BUX48 BUX48A

The Safe Operating Area figures shown in Figures 12 and 13 are specified for these devices under the test conditions shown.

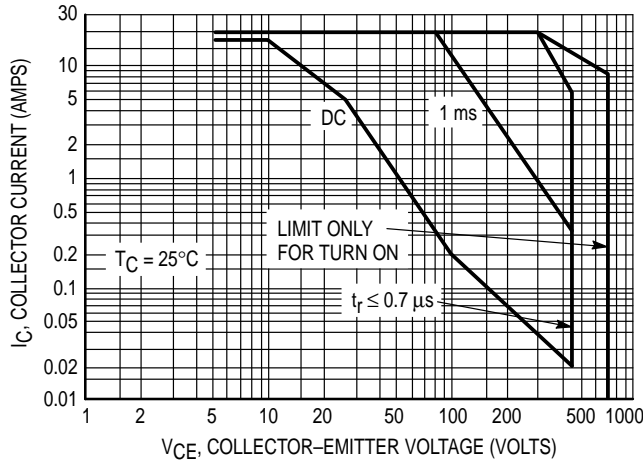

Figure 12. Forward Bias Safe Operating Area

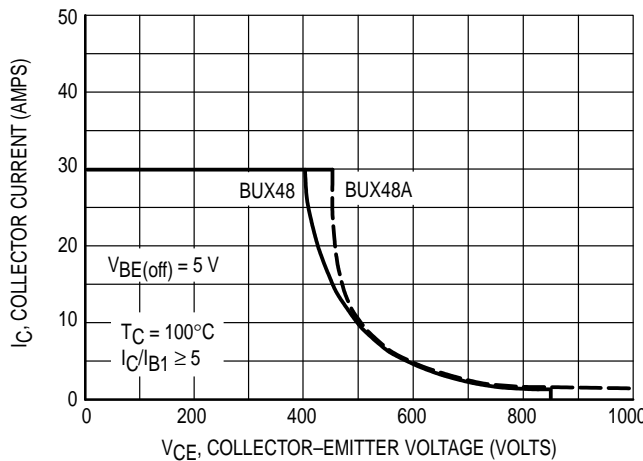

Figure 13. Reverse Bias Safe Operating Area

SAFE OPERATING AREA INFORMATION

FORWARD BIAS

There are two limitations on the power handling ability of a transistor: average junction temperature and second breakdown. Safe operating area curves indicate $I_C - V_{CE}$ limits of the transistor that must be observed for reliable operation; i.e., the transistor must not be subjected to greater dissipation than the curves indicate.

The data of Figure 12 is based on $T_C = 25^\circ\text{C}$; $T_J(\text{pk})$ is variable depending on power level. Second breakdown pulse limits are valid for duty cycles to 10% but must be derated when $T_C \geq 25^\circ\text{C}$. Second breakdown limitations do not derate the same as thermal limitations. Allowable current at the voltages shown on Figure 12 may be found at any case temperature by using the appropriate curve on Figure 14.

$T_J(\text{pk})$ may be calculated from the data in Figure 11. At high case temperatures, thermal limitations will reduce the power that can be handled to values less than the limitations imposed by second breakdown.

REVERSE BIAS

For inductive loads, high voltage and high current must be sustained simultaneously during turn-off, in most cases, with the base to emitter junction reverse biased. Under these conditions the collector voltage must be held to a safe level at or below a specific value of collector current. This can be accomplished by several means such as active clamping, RC snubbing, load line shaping, etc. The safe level for these devices is specified as Reverse Bias Safe Operating Area and represents the voltage-current conditions during reverse biased turn-off. This rating is verified under clamped conditions so that the device is never subjected to an avalanche mode. Figure 13 gives RBSOA characteristics.

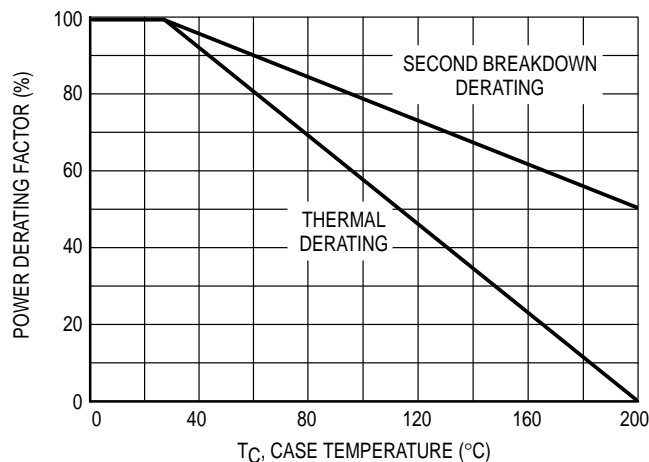

Figure 14. Power Derating

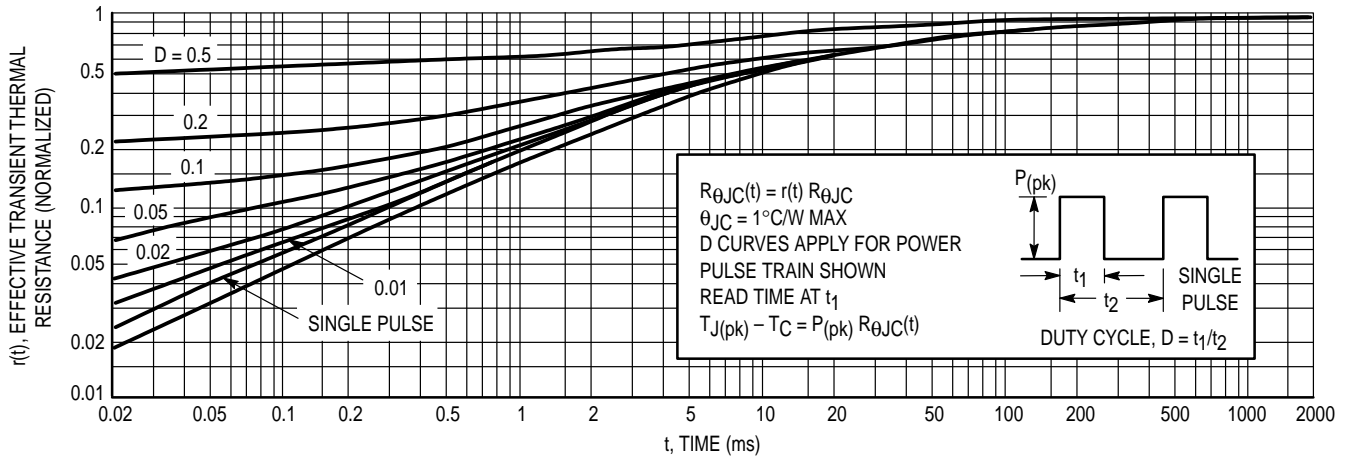

Figure 15. Thermal Response

OVERLOAD CHARACTERISTICS

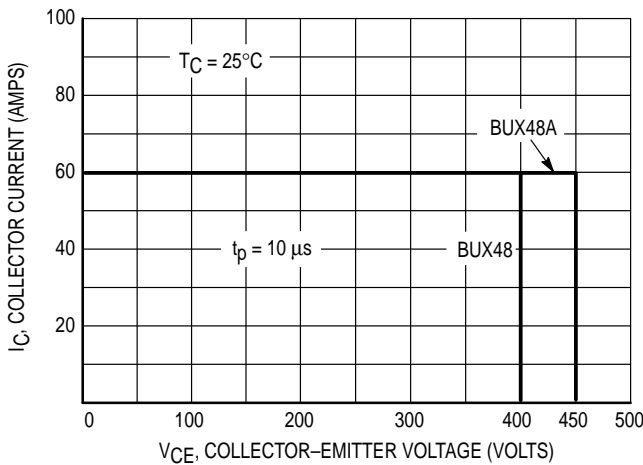

Figure 16. Rated Overload Safe Operating Area (OLSOA)

OLSOA

OLSOA applies when maximum collector current is limited and known. A good example is a circuit where an inductor is inserted between the transistor and the bus, which limits the rate of rise of collector current to a known value. If the transistor is then turned off within a specified amount of time, the magnitude of collector current is also known.

Maximum allowable collector-emitter voltage versus collector current is plotted for several pulse widths. (Pulse width is defined as the time lag between the fault condition and the removal of base drive.) Storage time of the transistor has been factored into the curve. Therefore, with bus voltage and maximum collector current known, Figure 16 defines the maximum time which can be allowed for fault detection and shutdown of base drive.

OLSOA is measured in a common-base circuit (Figure 18) which allows precise definition of collector-emitter voltage and collector current. This is the same circuit that is used to measure forward-bias safe operating area.

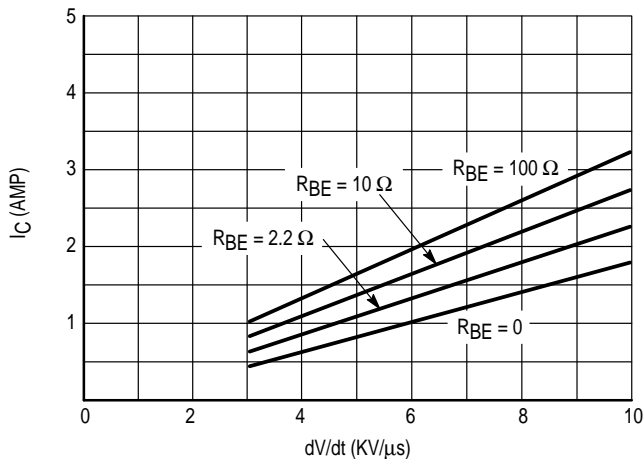

Figure 17. $I_C = f(dV/dt)$

Notes:

- $V_{CE} = V_{CC} + V_{BE}$
- Adjust pulsed current source for desired I_C, t_p

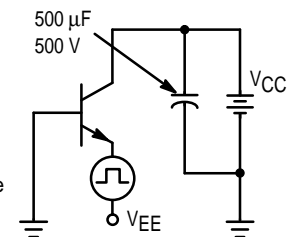
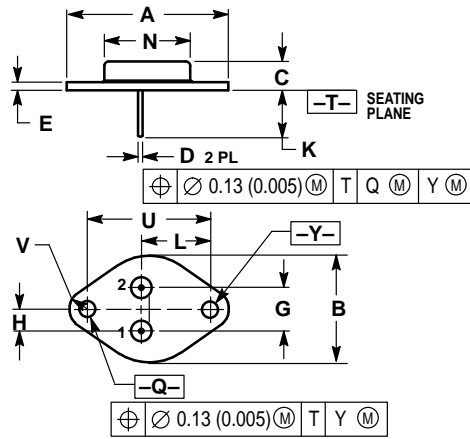

Figure 18. Overload SOA Test Circuit

PACKAGE DIMENSIONS



- NOTES:
1. DIMENSIONING AND TOLERANCING PER ANSI Y14.5M, 1982.
 2. CONTROLLING DIMENSION: INCH.
 3. ALL RULES AND NOTES ASSOCIATED WITH REFERENCED TO-204AA OUTLINE SHALL APPLY.

DIM	INCHES		MILLIMETERS	
	MIN	MAX	MIN	MAX
A	1.550 REF		39.37 REF	
B	—	1.050	—	26.67
C	0.250	0.335	6.35	8.51
D	0.038	0.043	0.97	1.09
E	0.055	0.070	1.40	1.77
G	0.430 BSC		10.92 BSC	
H	0.215 BSC		5.46 BSC	
K	0.440	0.480	11.18	12.19
L	0.665 BSC		16.89 BSC	
N	—	0.830	—	21.08
Q	0.151	0.165	3.84	4.19
U	1.187 BSC		30.15 BSC	
V	0.131	0.188	3.33	4.77

- STYLE 1:
1. BASE
 2. EMITTER
- CASE: COLLECTOR

**CASE 1-07
TO-204AA (TO-3)
ISSUE Z**

Motorola reserves the right to make changes without further notice to any products herein. Motorola makes no warranty, representation or guarantee regarding the suitability of its products for any particular purpose, nor does Motorola assume any liability arising out of the application or use of any product or circuit, and specifically disclaims any and all liability, including without limitation consequential or incidental damages. "Typical" parameters can and do vary in different applications. All operating parameters, including "Typicals" must be validated for each customer application by customer's technical experts. Motorola does not convey any license under its patent rights nor the rights of others. Motorola products are not designed, intended, or authorized for use as components in systems intended for surgical implant into the body, or other applications intended to support or sustain life, or for any other application in which the failure of the Motorola product could create a situation where personal injury or death may occur. Should Buyer purchase or use Motorola products for any such unintended or unauthorized application, Buyer shall indemnify and hold Motorola and its officers, employees, subsidiaries, affiliates, and distributors harmless against all claims, costs, damages, and expenses, and reasonable attorney fees arising out of, directly or indirectly, any claim of personal injury or death associated with such unintended or unauthorized use, even if such claim alleges that Motorola was negligent regarding the design or manufacture of the part. Motorola and are registered trademarks of Motorola, Inc. Motorola, Inc. is an Equal Opportunity/Affirmative Action Employer.

How to reach us:
USA / EUROPE: Motorola Literature Distribution;
 P.O. Box 20912; Phoenix, Arizona 85036. 1-800-441-2447

JAPAN: Nippon Motorola Ltd.; Tatsumi-SPD-JLDC, Toshikatsu Otsuki,
 6F Seibu-Butsuryu-Center, 3-14-2 Tatsumi Koto-Ku, Tokyo 135, Japan. 03-3521-8315

MFAX: RMFAX0@email.sps.mot.com - TOUCHTONE (602) 244-6609
INTERNET: http://Design-NET.com

HONG KONG: Motorola Semiconductors H.K. Ltd.; 8B Tai Ping Industrial Park,
 51 Ting Kok Road, Tai Po, N.T., Hong Kong. 852-26629298

