

## Current Regulator Diodes

<b>J500</b>	<b>J503</b>	<b>J506</b>	<b>J509</b>
<b>J501</b>	<b>J504</b>	<b>J507</b>	<b>J510</b>
<b>J502</b>	<b>J505</b>	<b>J508</b>	<b>J511</b>

PRODUCT SUMMARY					
Part Number	Typ I <sub>F</sub> (mA)	P <sub>OV</sub> (V)	Part Number	Typ I <sub>F</sub> (mA)	P <sub>OV</sub> (V)
J500	0.24	50	J506	1.40	50
J501	0.33	50	J507	1.80	50
J502	0.43	50	J508	2.40	50
J503	0.56	50	J509	3.00	50
J504	0.75	50	J510	3.60	50
J505	1.00	50	J511	4.70	50

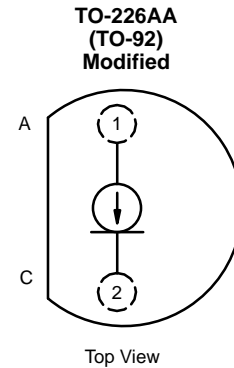

### FEATURES

- Two-Lead Plastic Package
- Guaranteed  $\pm 20\%$  Tolerance
- Operation from 1 V (J500–J503) to 50 V
- Excellent Temperature Stability

### BENEFITS

- Simple Series Circuitry, No Separate Voltage Source
- Tight Guaranteed Circuit Performance
- Excellent Performance in Low-Voltage/Battery Circuits and High-Voltage Spike Protection
- High Circuit Stability vs. Temperature

### APPLICATIONS

- Constant-Current Supply
- Current-Limiting
- Timing Circuits

### DESCRIPTION

The J500 series is a family of  $\pm 20\%$  range current regulators designed for demanding applications in test equipment and instrumentation. These devices utilize the JFET techniques to produce a single two-leaded device which is extremely simple to operate.

With nominal current ranges from 0.24 mA to 4.7 mA, the J500 series will meet a wide array of design requirements.

The low-cost TO-226A package ensures a cost-effective design solution.

### SCHEMATIC DIAGRAM

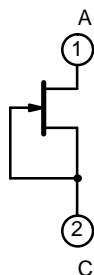

### APPLICATIONS

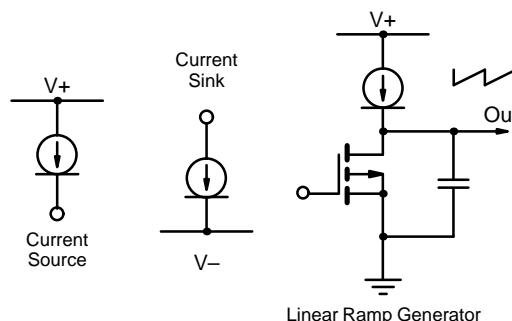

Applications information may be obtained via FaxBack, request document #70596.



### ABSOLUTE MAXIMUM RATINGS

Peak Operating Voltage ..... 50 V  
 Reverse Current ..... 50 mA  
 Storage Temperature ..... -55 to 150°C

Power Dissipation<sup>a</sup> ..... 350 mW

Notes:

a. Derate 2.8 mW/°C above 25°C

SPECIFICATIONS <sup>a</sup>						
Parameter	Symbol	Test Conditions	Limits			Unit
			Min	Typ NO TAG	Max	
Peak Operating Voltage	P <sub>OV</sub>	I <sub>F</sub> = 1.1 I <sub>F(max)</sub> NO TAG	50	95		V
Reverse Voltage	V <sub>R</sub>	I <sub>R</sub> = 1 mA		0.8		
Capacitance	C <sub>F</sub>	V <sub>F</sub> = 25 V, f = 1 MHz		2.2		pF

Part Number	Regulator Current <sup>d</sup> (I <sub>F</sub> )			Dynamic Impedance <sup>e</sup> (Z <sub>d</sub> )		Knee Impedance (Z <sub>k</sub> )	Limiting Voltage <sup>f</sup> (V <sub>L</sub> )		Temperature Coefficient (θ <sub>1</sub> )
	V <sub>F</sub> = 25 V			V <sub>F</sub> = 25 V		V <sub>F</sub> = 6 V	I <sub>F</sub> = 0.8 I <sub>F(min)</sub>		V <sub>F</sub> = 25 V 0°C ≤ T <sub>A</sub> ≤ 100°C
	mA			MΩ		MΩ	V		%/°C
	Min	Nom	Max	Min	Typ <sup>b</sup>	Typ <sup>b</sup>	Max	Typ <sup>b</sup>	Typ <sup>b</sup>
J500	0.192	0.24	0.288	4.00	15	2.50	1.2	0.4	0.95%
J501	0.264	0.33	0.396	2.20	10	1.60	1.3	0.5	0.81%
J502	0.344	0.43	0.516	1.50	7	1.10	1.5	0.6	0.70%
J503	0.448	0.56	0.672	1.20	5	0.80	1.7	0.7	0.58%
J504	0.600	0.75	0.900	0.80	3.5	0.55	1.9	0.8	0.46%
J505	0.800	1.00	1.200	0.50	2	0.40	2.1	0.9	0.33%
J506	1.120	1.40	1.680	0.33	1.5	0.25	2.5	1.1	0.19%
J507	1.440	1.80	2.160	0.20	1	0.19	2.8	1.3	0.08%
J508	1.900	2.40	2.900	0.20	0.7	0.13	3.1	1.5	-0.05%
J509	2.400	3.00	3.600	0.15	0.5	0.09	3.5	1.7	-0.14%
J510	2.900	3.60	4.300	0.15	0.4	0.07	3.9	1.9	-0.22%
J511	3.800	4.70	5.600	0.12	0.3	0.05	4.2	2.1	-0.34%

Notes:

- T<sub>A</sub> = 25°C unless otherwise noted.
- Typical values are for DESIGN AID ONLY, not guaranteed nor subject to production testing.
- Max V<sub>F</sub> where I<sub>F</sub> = 1.1 I<sub>F(max)</sub> is guaranteed.
- Pulse test—steady state currents may vary.
- Pulse test—steady state impedances may vary.
- Min V<sub>F</sub> required to insure I<sub>F</sub> = 0.8 I<sub>F(min)</sub>.

NCL



**TYPICAL CHARACTERISTICS**

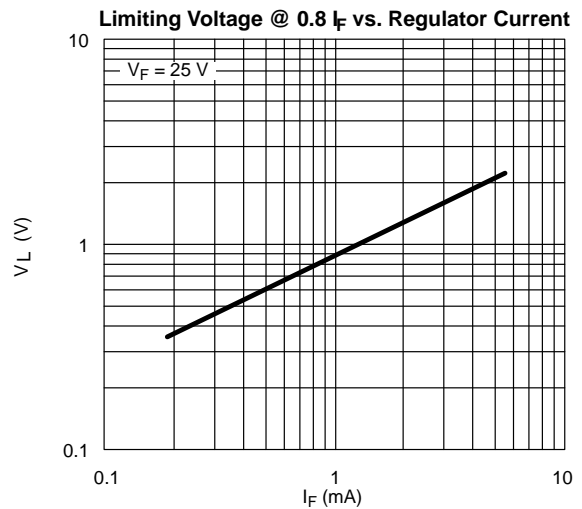
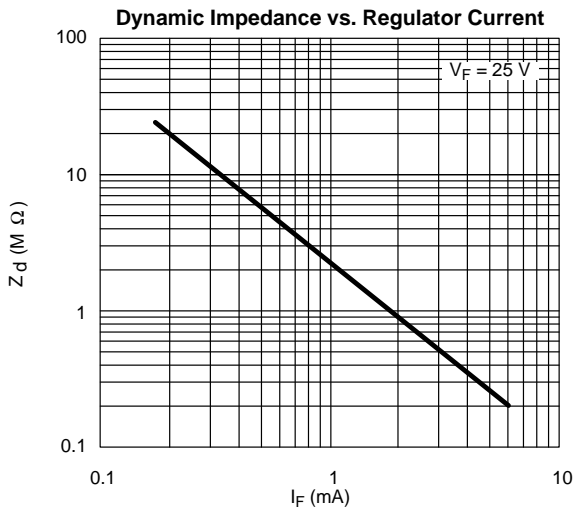
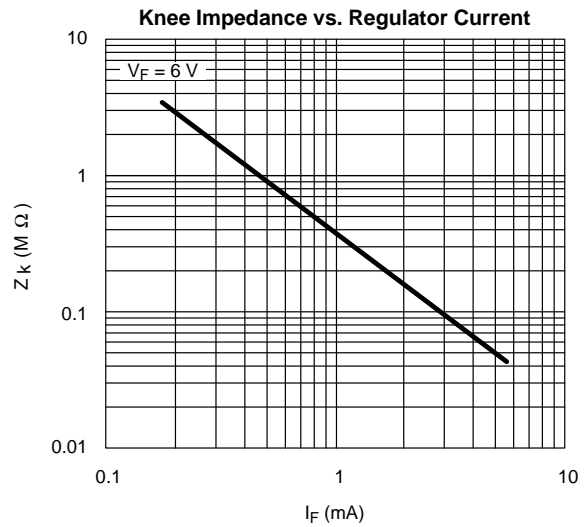
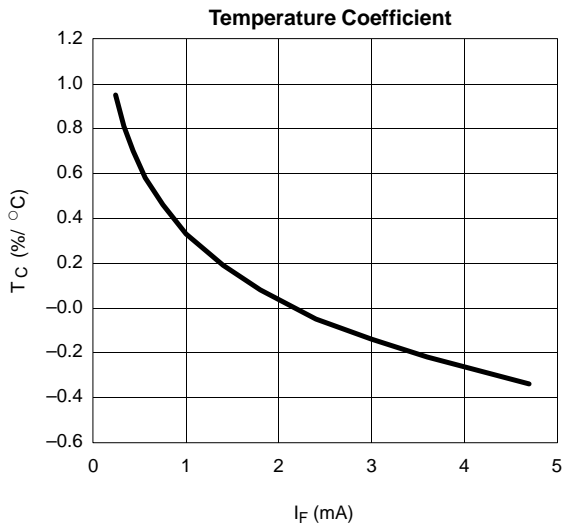
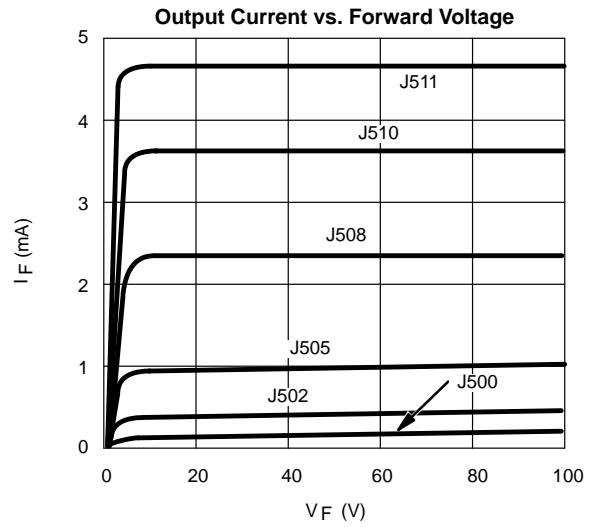
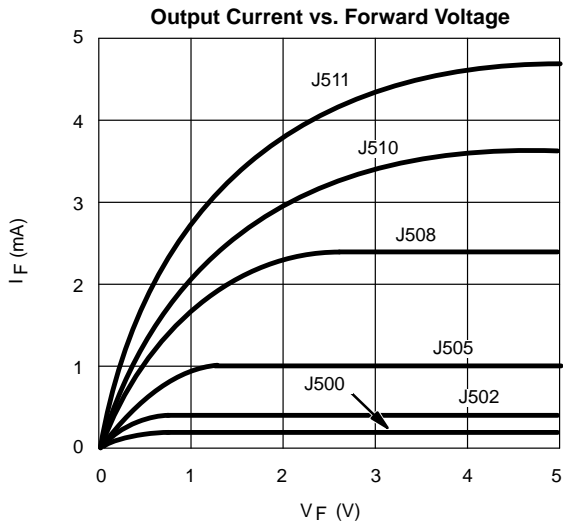

**TYPICAL CHARACTERISTICS**

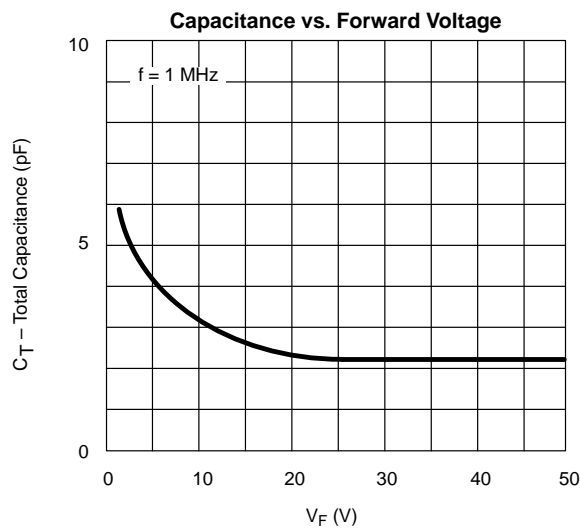
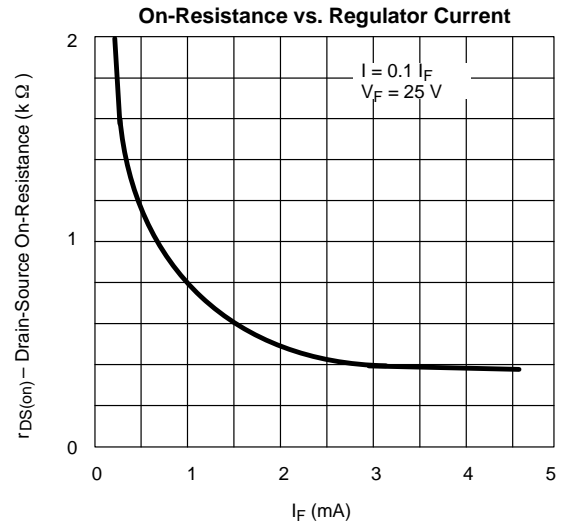
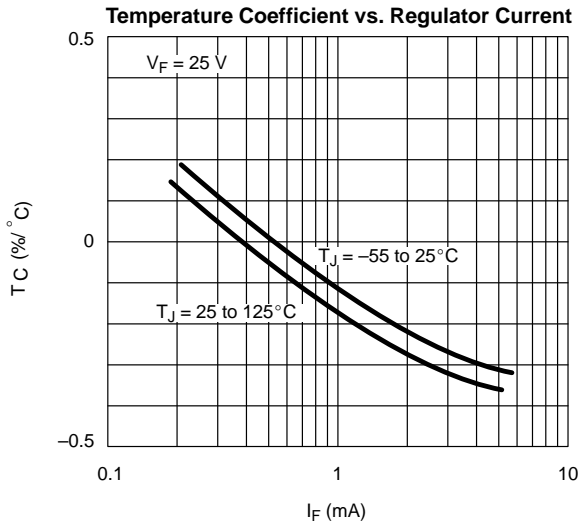

**CURRENT REGULATOR DIODE V-1 CHARACTERISTIC**

