

## Series PVR13N

Microelectronic Power IC  
HEXFET® Power MOSFET Photovoltaic Relay  
Dual-Pole, Normally-Open  
0-100V AC/DC, 360mA

### General Description

The PVR13 Series AC/DC Relay is a dual-pole, normally open, solid-state replacement for electromechanical relays used for general purpose switching of analog signals. It utilizes International Rectifier's HEXFET power MOSFETs as the output switches, driven by an integrated circuit photovoltaic generator of novel construction. The output switch is controlled by radiation from a GaAlAs light emitting diode (LED), which is optically isolated from the photovoltaic generator.

The PVR13 Series overcomes the limitations of both conventional electromechanical and reed relays by offering the solid state advantages of long life, fast operating speed, low pick up power, bounce-free operation, low thermal offset voltages and miniature package. These advantages allow product improvement and design innovations in many applications such as process control, multiplexing, automatic test equipment and data acquisition.

The PVR13 can switch analog signals from thermocouple level to 100 Volts peak AC or DC polarity. Signal frequencies into the RF range are easily controlled and switching rates up to 450Hz are achievable. The extremely small thermally generated offset voltages allow increased measurement accuracies.

These relays are packaged in 16-pin, molded DIP packages and available with through-hole leads, in plastic shipping tubes.

### Applications

- Process Control
- Data Acquisition
- Test Equipment
- Multiplexing and Scanning

### Features

- Bounce-Free Operation
- $10^{10}$  Off-State Resistance
- 1,000 V/ $\mu$ sec dv/dt
- 0.2  $\mu$ V Thermal Offset
- 5 mA Input Sensitivity
- 1,500 V<sub>RMS</sub> I/O Isolation
- Solid-State Reliability

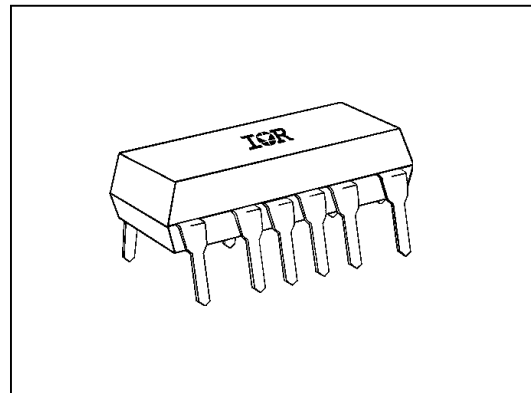

### Part Identification

PVR1300N  
PVR1301N

*(HEXFET is the registered trademark for International Rectifier Power MOSFETs)*

## Series PVR13N

International  
IRF Rectifier

### Electrical Specifications ( $-40^{\circ}\text{C} \leq T_A \leq +85^{\circ}\text{C}$ unless otherwise specified)

INPUT CHARACTERISTICS		Units
Minimum Control Current A Connection (see figure 1)		DC
For 400 Continuous Load Current	2.0	mA@25°C
For 360 Continuous Load Current	5.0	mA@40°C
For 250 Continuous Load Current	5.0	mA@85°C
Minimum Turn-Off Current	10	μA(DC)
Minimum Turn-Off Voltage	0.6	V(DC)
Control Current Range (Caution: current limit input LED. See figure 6)	2.0 to 25	mA(DC)
Maximum Reverse Voltage	7.0	V(DC)

OUTPUT CHARACTERISTICS		Units
Operating Voltage Range	±100	V <sub>(peak)</sub>
Maximum Load Current 40°C I <sub>LED</sub> = 5mA (see figure 1)		
AC (A Connection)	360	mA (peak)
DC (B Connection)	420	mA(DC)
DC (C Connection)	660	mA(DC)
Response Time @25°C (see figures 7 and 8)		
Maximum T <sub>(on)</sub> @ 12mA Control, 100 mA Load, 100 VDC	150	μs
Maximum T <sub>(off)</sub> @ 12mA Control, 100 mA Load, 100 VDC	70	μs
Maximum On-state Resistance 25°C (Pulsed) (fig. 2) 50 mA Load, 5mA Control		
AC (A Connection)	5	Ω
DC (B Connection)	3.0	Ω
DC (C Connection)	1.5	Ω
Minimum Off-state Resistance 25°C		
@ 80 VDC PVR1300	10 <sup>9</sup>	Ω
@ 80 VDC PVR1301	10 <sup>10</sup>	Ω
Maximum Thermal Offset Voltage @ 5.0mA Control	0.2	μvolts
Minimum Off-State dv/dt	1000	V/μs
Typical Output Capacitance (see figure 9)	12	pF @ 50VDC

GENERAL CHARACTERISTICS		Units
Dielectric Strength: Input-Output	1500	V <sub>RMS</sub>
Insulation Resistance: Input-Output @ 500V <sub>DC</sub>	10 <sup>12</sup>	Ω
Maximum Capacitance: Input-Output	1.0	pF
Maximum Lead Soldering Temperature (1.6mm below seating plane for 10 sec.)	260	°C
Ambient Temperature Range:		
Operating	-40 to +85	°C
Storage	-40 to +100	

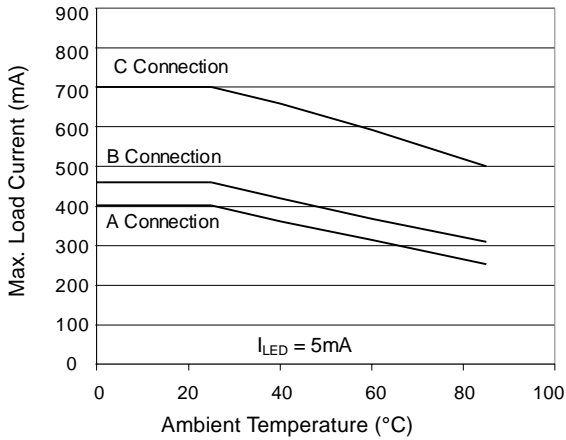

Figure 1. Current Derating Curve

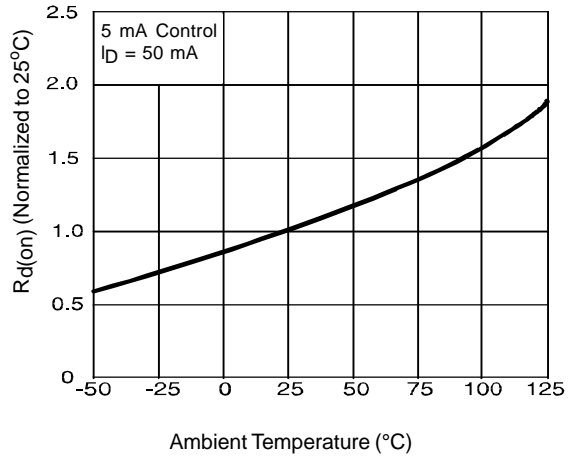

Figure 2. Typical Normalized On-Resistance

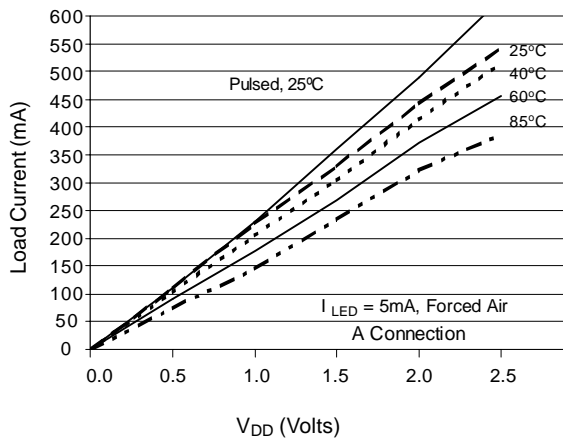

Figure 3. Typical On-Characteristic A Connection

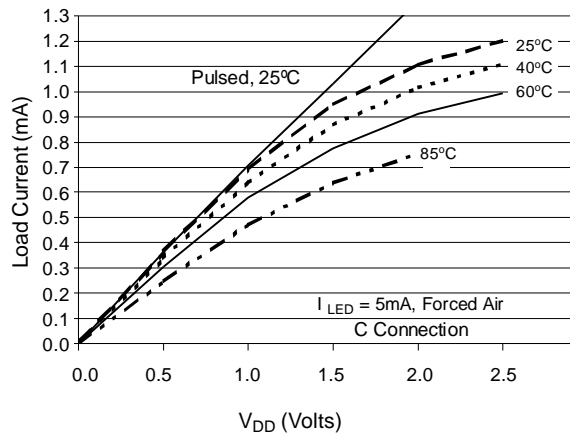

Figure 4. Typical On-Characteristic C Connection

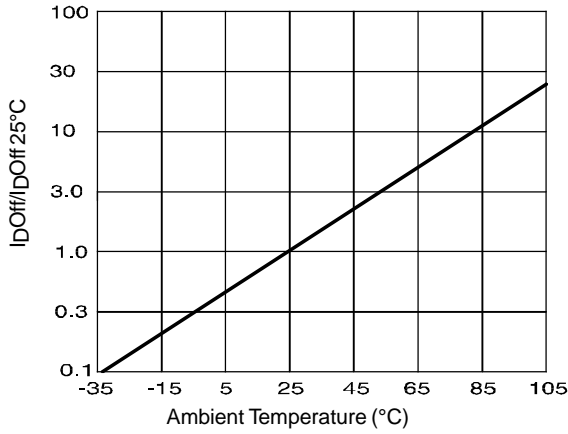

Figure 5. Typical Normalized Off-State Leakage

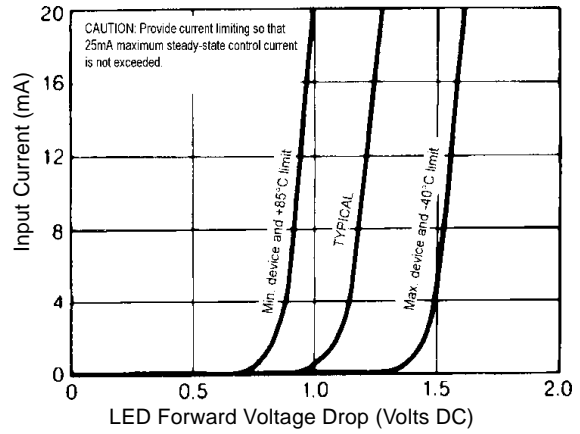

Figure 6. Input Characteristics (Current Controlled)

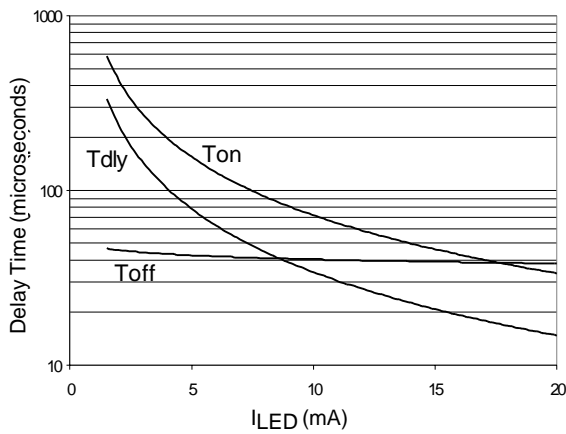

Figure 7. Typical Delay Times

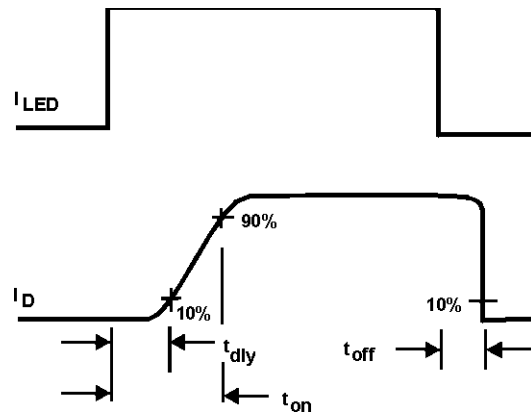
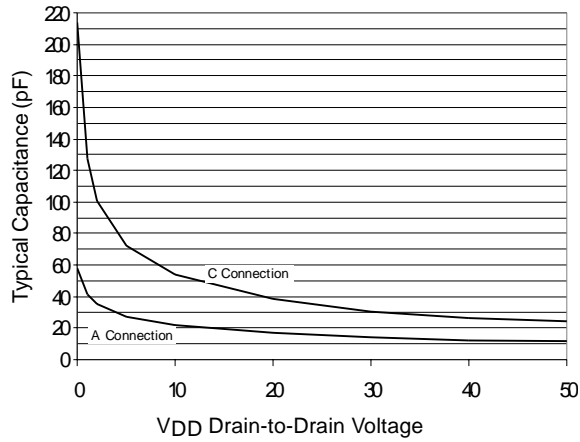

Figure 8. Delay Time Definitions



**Figure 9. Typical Output Capacitance**

**Wiring Diagram**

**Schematic Diagram**

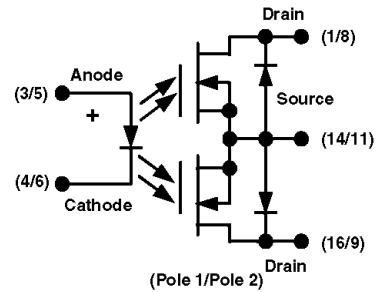
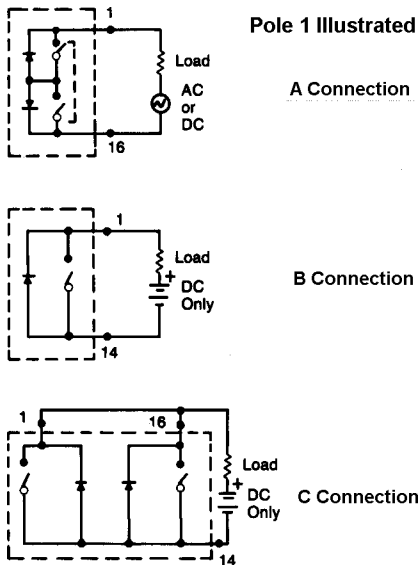

Case Outline

