

RECTIFIER DIODE

AR447PC

Repetitive voltage up to **2400 V**
Mean forward current **2395 A**
Surge current **18 kA**

TARGET SPECIFICATION

lug 02 - ISSUE : 2

Symbol	Characteristic	Conditions	T _j [°C]	Value	Unit
BLOCKING					
V _{RRM}	Repetitive peak reverse voltage		175	2400	V
V _{RSM}	Non-repetitive peak reverse voltage		175	2500	V
I _{RRM}	Repetitive peak reverse current	V=VRRM	175	50	mA
CONDUCTING					
I _{F(AV)}	Mean forward current	180° sin, 50 Hz, Th=55°C, double side cooled		2395	A
I _{F(AV)}	Mean forward current	180° sin, 50 Hz, Tc=85°C, double side cooled		2570	A
I _{FSM}	Surge forward current	Sine wave, 10 ms without reverse voltage	175	18	kA
I ² t	I ² t			1620 x 1E3	A ² s
V _{FM}	Forward voltage	Forward current = 1800 A	175	1.30	V
V _{F(TO)}	Threshold voltage		175	0.85	V
r _F	Forward slope resistance		175	0.260	mohm
SWITCHING					
t _{rr}	Reverse recovery time		175		μs
Q _{rr}	Reverse recovery charge				μC
I _{rr}	Peak reverse recovery current				A
MOUNTING					
R _{th(j-h)}	Thermal impedance, DC	Junction to heatsink, double side cooled		21	°C/kW
R _{th(c-h)}	Thermal impedance	Case to heatsink, double side cooled		7	°C/kW
T _j	Operating junction temperature			-30 / 175	°C
F	Mounting force			11.8 / 13.2	kN
	Mass			90	g
<p>ORDERING INFORMATION : AR447PC S 24</p> <p>standard specification <input type="checkbox"/> VRRM/100 <input type="checkbox"/></p>					

DISSIPATION CHARACTERISTICS

SQUARE WAVE

T_c [°C]

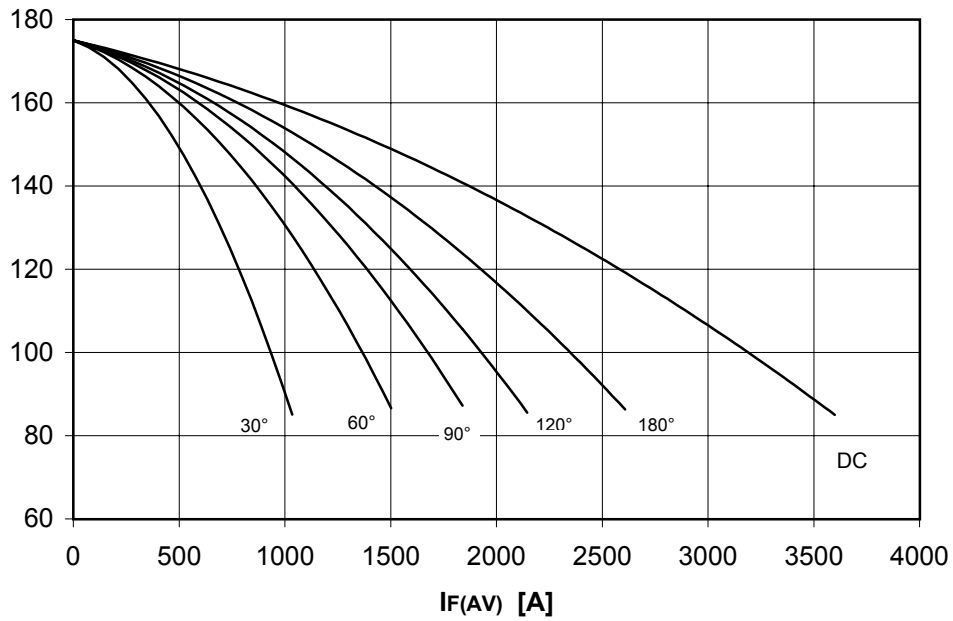

$P_{F(AV)}$ [W]

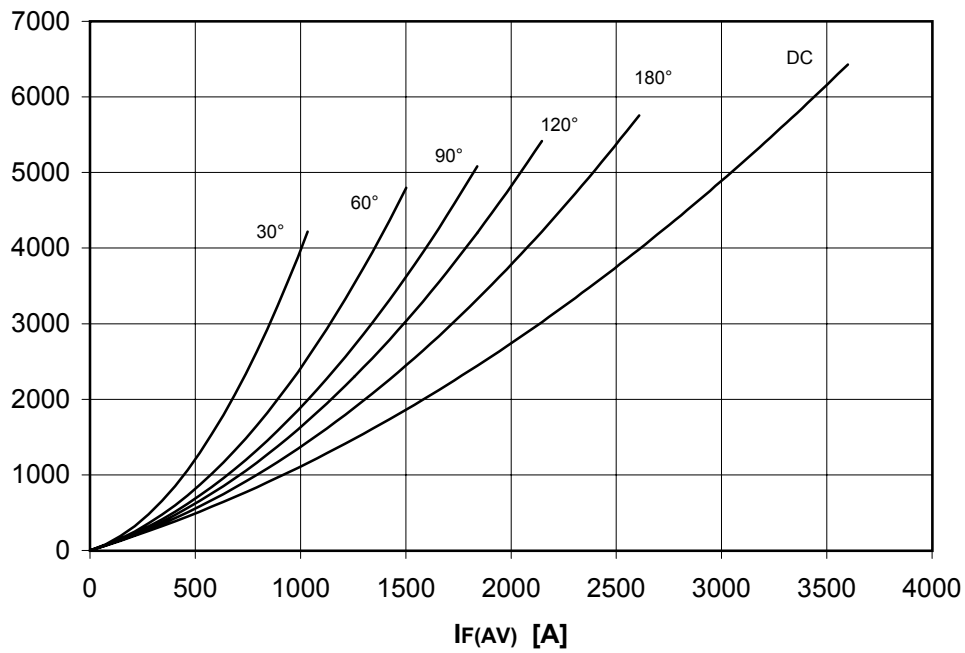

DISSIPATION CHARACTERISTICS

SINE WAVE

T_c [°C]

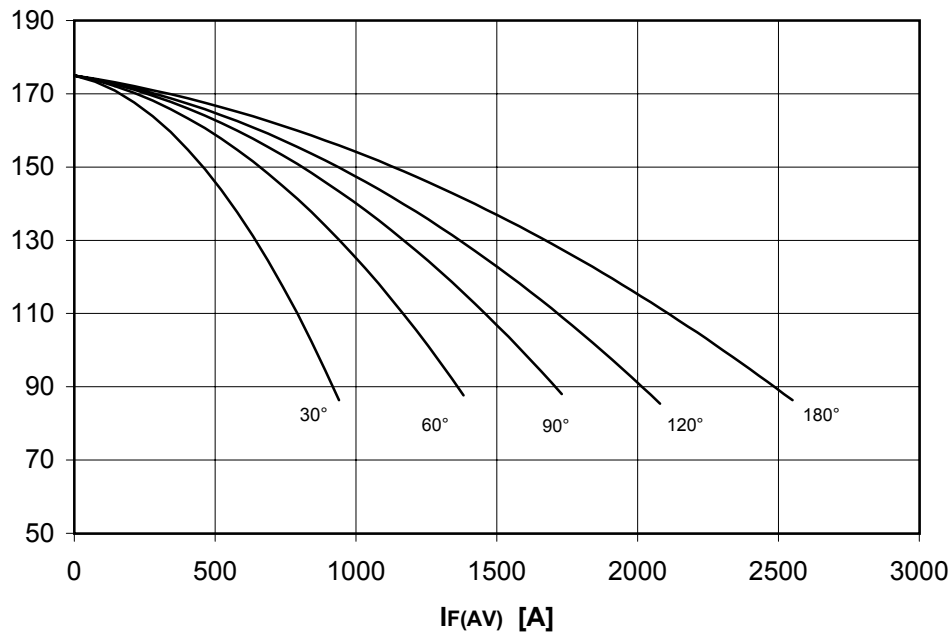

$P_F(AV)$ [W]

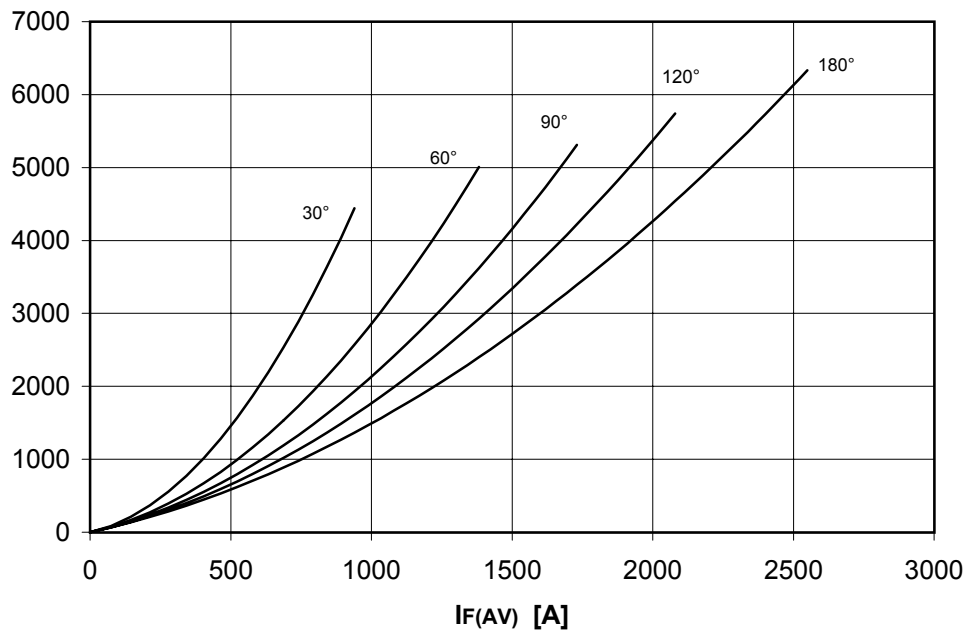

AR447PC RECTIFIER DIODE



TARGET SPECIFICATION lug 02 - ISSUE : 2

FORWARD CHARACTERISTIC
T_j = 175 °C

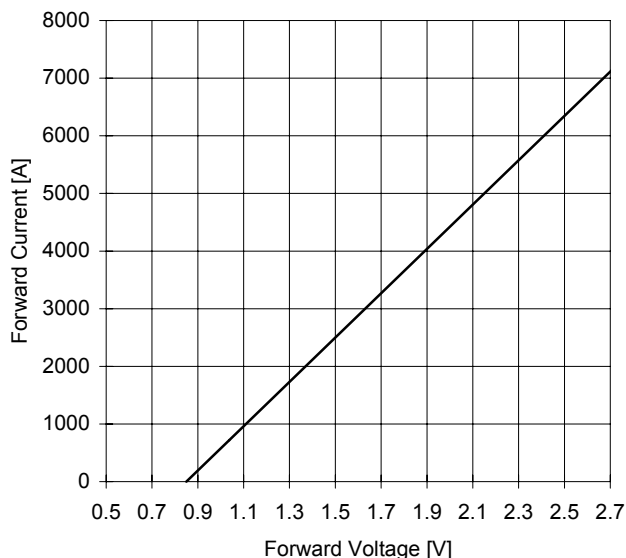

SURGE CHARACTERISTIC
T_j = 175 °C

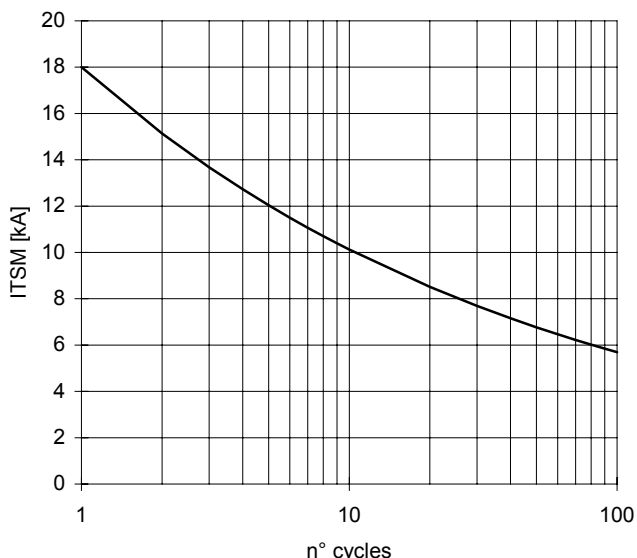

TRANSIENT THERMAL IMPEDANCE
DOUBLE SIDE COOLED

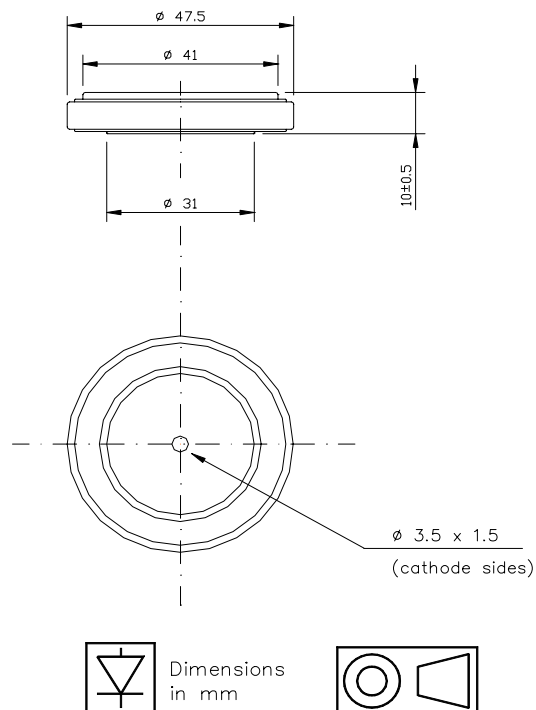
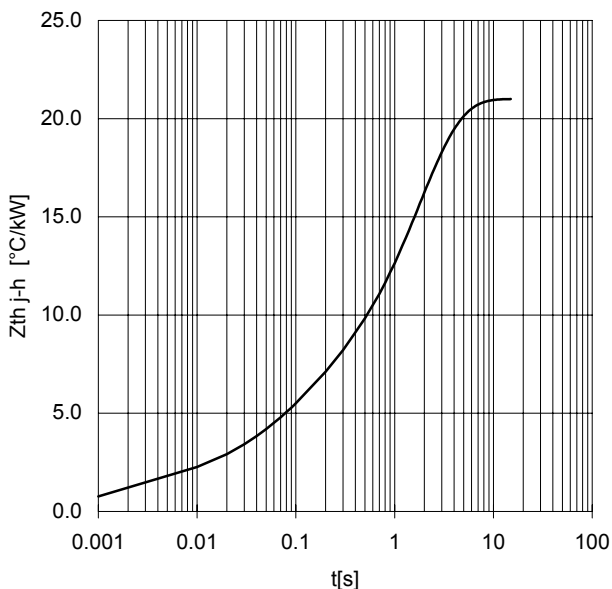

PLASTIC CASE DEVICE

All the characteristics given in this data sheet are guaranteed only with uniform clamping force, cleaned and lubricated heatsink, surfaces with flatness < .03 mm and roughness < 2 μm.
In the interest of product improvement POSEICO SPA reserves the right to change any data given in this data sheet at any time without previous notice.
If not stated otherwise the maximum value of ratings (symbols over shaded background) and characteristics is reported.

Distributed by

