

International IR Rectifier

403CMQ... Series

SCHOTTKY RECTIFIER

400 Amp

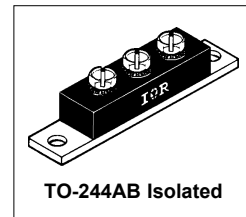

Major Ratings and Characteristics

Characteristics	403CMQ...	Units
$I_{F(AV)}$ Rectangular waveform	400	A
V_{RRM} Range	80 to 100	V
I_{FSM} @tp = 5 μ s sine	25,500	A
V_F @200Apk, $T_J = 125^\circ\text{C}$ (per leg)	0.69	V
T_J range	-55 to 175	$^\circ\text{C}$

Description/Features

The 403CMQ high current Schottky rectifier module series has been optimized for low reverse leakage at high temperature. The proprietary barrier technology allows for reliable operation up to 175 $^\circ\text{C}$ junction temperature. Typical applications are in high current switching power supplies, plating power supplies, UPS systems, converters, free-wheeling diodes, welding, and reverse battery protection.

- 175 $^\circ\text{C}$ T_J operation
- Center tap module - Isolated Base
- High purity, high temperature epoxy encapsulation for enhanced mechanical strength and moisture resistance
- Low forward voltage drop
- High frequency operation
- Guard ring for enhanced ruggedness and long term reliability

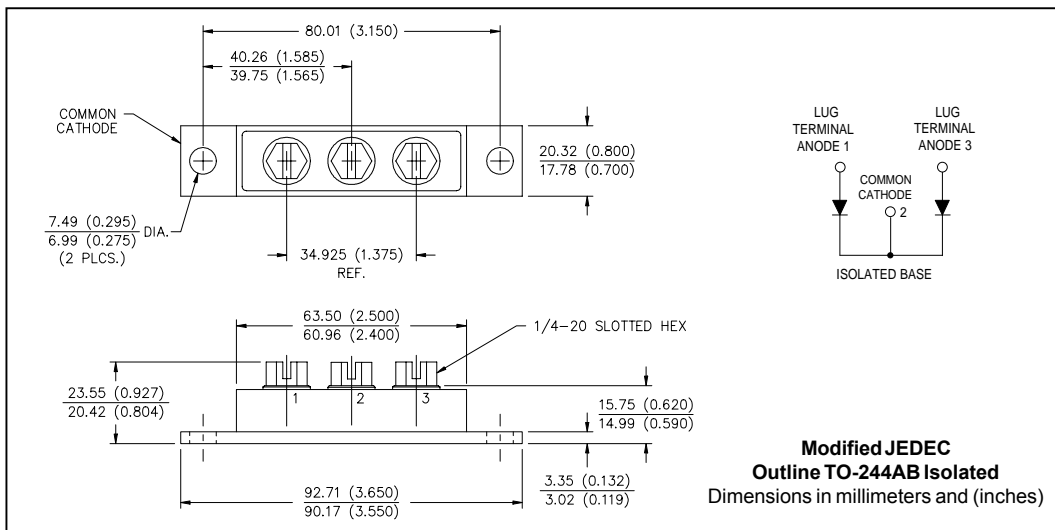

403CMQ... Series

Bulletin PD-20726 rev. B 08/01

International
IR Rectifier

Voltage Ratings

Parameters	403CMQ080	403CMQ100
V_R Max. DC Reverse Voltage (V)	80	100
V_{RWM} Max. Working Peak Reverse Voltage (V)		

Absolute Maximum Ratings

Parameters	403CMQ	Units	Conditions
$I_{F(AV)}$ Max. Average Forward Current (Per Leg) (Per Device)	200 400	A	50% duty cycle @ $T_C = 85^\circ\text{C}$, rectangular waveform
I_{FSM} Max. Peak One Cycle Non-Repetitive Surge Current (Per Leg)	25500 3300	A	5 μs Sine or 3 μs Rect. pulse 10ms Sine or 6ms Rect. pulse Following any rated load condition and with rated V_{RWM} applied
E_{AS} Non-Repetitive Avalanche Energy (Per Leg)	15	mJ	$T_J = 25^\circ\text{C}$, $I_{AS} = 1$ Amps, $L = 30$ mH
I_{AR} Repetitive Avalanche Current (Per Leg)	1	A	Current decaying linearly to zero in 1 μsec Frequency limited by T_J max. $V_A = 1.5 \times V_R$ typical

Electrical Specifications

Parameters	403CMQ	Units	Conditions
V_{FM} Max. Forward Voltage Drop (Per Leg) (1)	0.83	V	@ 200A $T_J = 25^\circ\text{C}$
	0.97	V	@ 400A
	0.69	V	@ 200A $T_J = 125^\circ\text{C}$
	0.82	V	@ 400A
I_{RM} Max. Reverse Leakage Current (Per Leg) (1)	6	mA	$T_J = 25^\circ\text{C}$
	140	mA	$T_J = 125^\circ\text{C}$ $V_R = \text{rated } V_R$
C_T Max. Junction Capacitance (Per Leg)	5500	pF	$V_R = 5V_{DC}$, (test signal range 100Khz to 1Mhz) 25°C
L_S Typical Series Inductance (Per Leg)	5.0	nH	From top of terminal hole to mounting plane
dv/dt Max. Voltage Rate of Change	10000	V/ μs	(Rated V_R)
V_{RMS} Insulation Voltage	1000	V	

(1) Pulse Width < 300 μs , Duty Cycle < 2%

Thermal-Mechanical Specifications

Parameters	403CMQ	Units	Conditions
T_J Max. Junction Temperature Range	-55 to 175	$^\circ\text{C}$	
T_{stg} Max. Storage Temperature Range	-55 to 175	$^\circ\text{C}$	
R_{thJC} Max. Thermal Resistance Junction to Case (Per Leg)	0.40	$^\circ\text{C/W}$	DC operation
R_{thJC} Max. Thermal Resistance Junction to Case (Per Package)	0.20	$^\circ\text{C/W}$	DC operation
R_{thCS} Typical Thermal Resistance, Case to Heatsink	0.10	$^\circ\text{C/W}$	Mounting surface, smooth and greased
wt Approximate Weight	79(2.80)	g(oz.)	
T Mounting Torque Base	Min.	24(20)	Kg-cm (lbf-in)
	Max.	35(30)	
	Typ.	13.5(12)	
	Min.	35(30)	
	Max.	46(40)	
Case Style	TO-244AB Isolated		Modified JEDEC

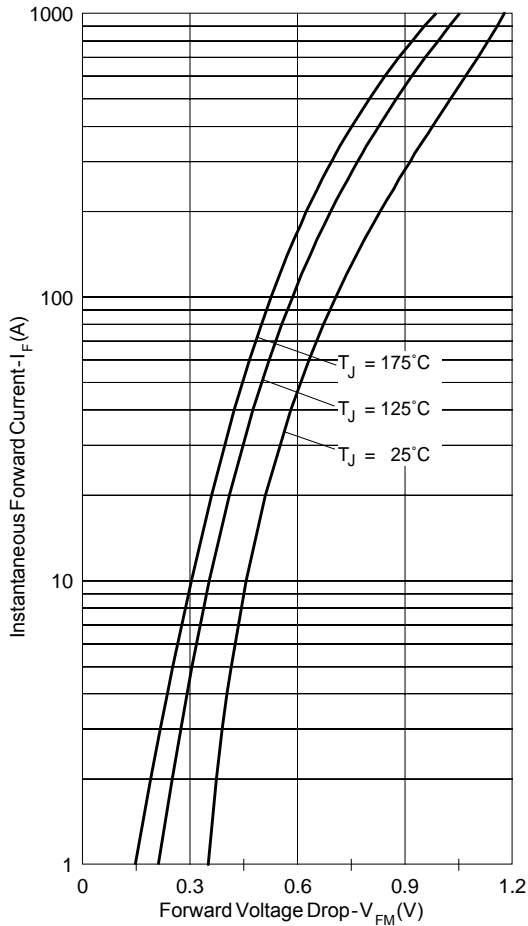

Fig. 1 - Max. Forward Voltage Drop Characteristics

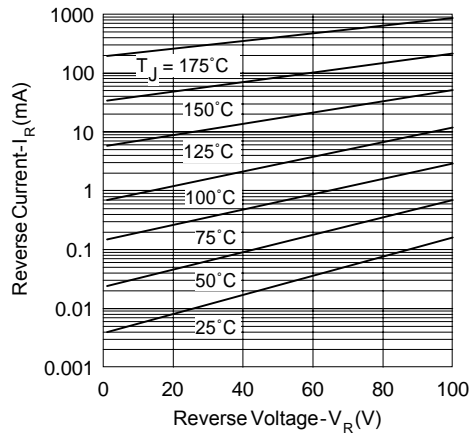

Fig. 2 - Typical Values Of Reverse Current Vs. Reverse Voltage

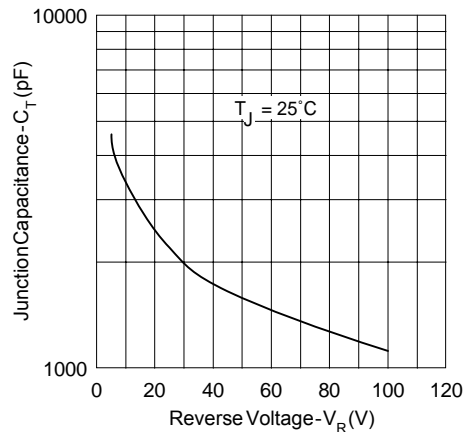

Fig. 3 - Typical Junction Capacitance Vs. Reverse Voltage

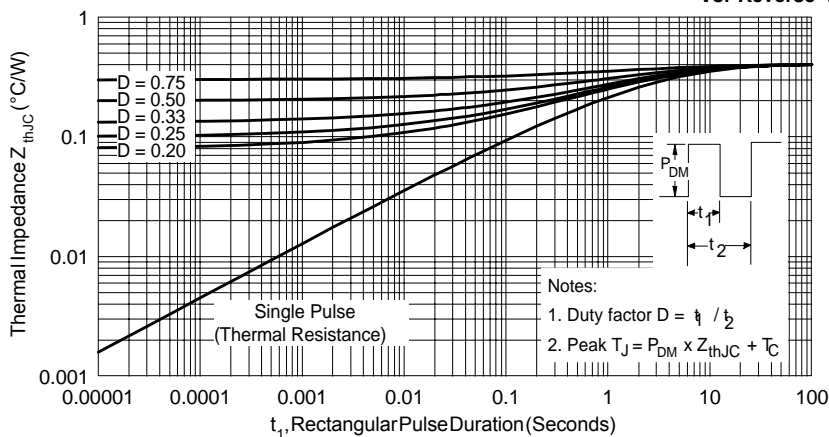

Fig. 4 - Max. Thermal Impedance Z_{thJC} Characteristics

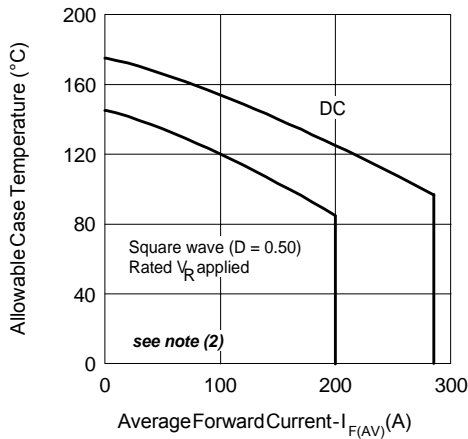

Fig. 5 - Max. Allowable Case Temperature Vs. Average Forward Current

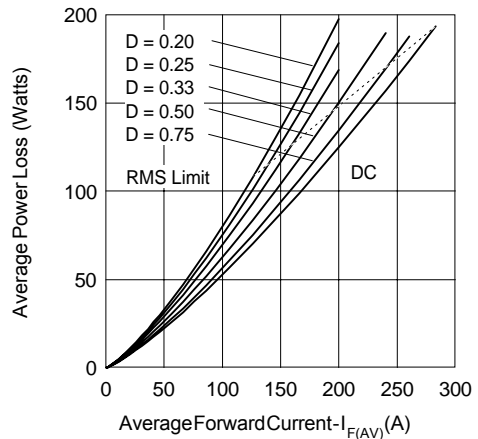

Fig. 6 - Forward Power Loss Characteristics

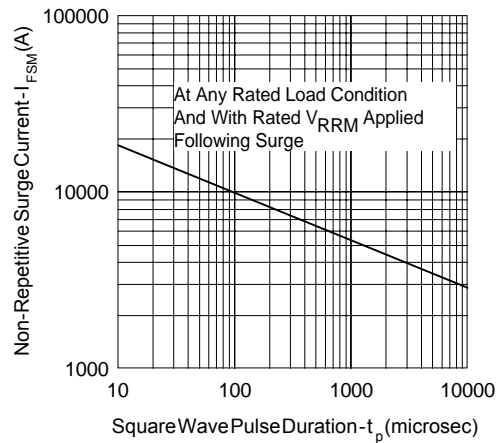

Fig. 7 - Max. Non-Repetitive Surge Current

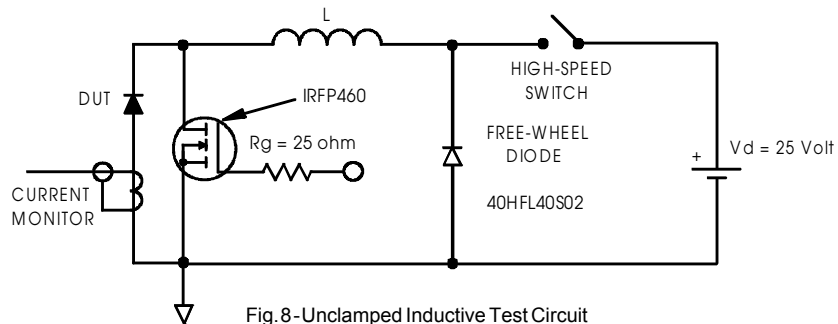

Fig. 8 - Unclamped Inductive Test Circuit

(2) Formula used: $T_C = T_J - (Pd + Pd_{REV}) \times R_{thJC}$;

Pd = Forward Power Loss = $I_{F(AV)} \times V_{FM} @ (I_{F(AV)} / D)$ (see Fig. 6);

Pd_{REV} = Inverse Power Loss = $V_{R1} \times I_R (1 - D)$; $I_R @ V_{R1} = 80\%$ rated V_R

Ordering Information Table

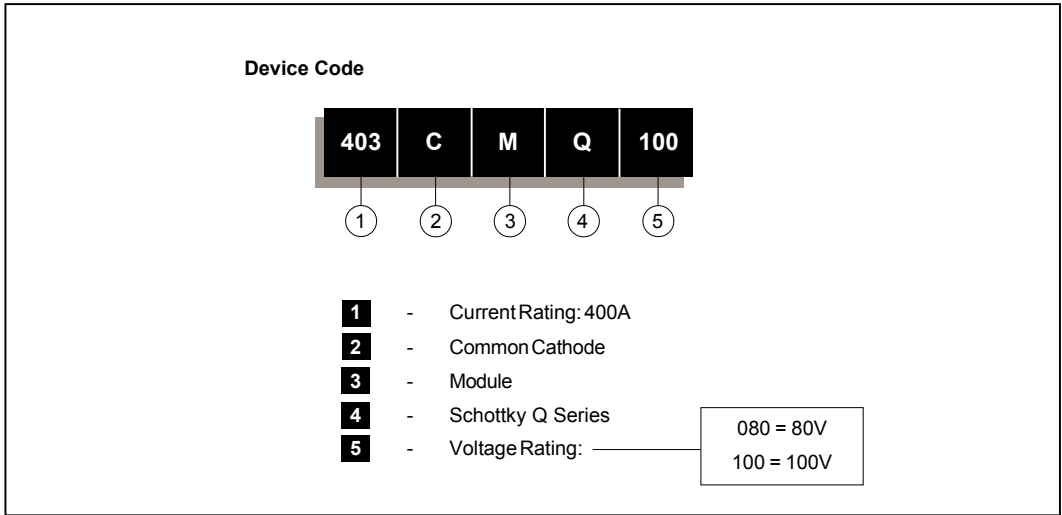

Data and specifications subject to change without notice.
 This product has been designed and qualified for Industrial Level.
 Qualification Standards can be found on IR's Web site.