

MC74LCX245

Low-Voltage CMOS Octal Transceiver

With 5 V-Tolerant Inputs and Outputs (3-State, Inverting)

The MC74LCX245 is a high performance, non-inverting octal transceiver operating from a 2.3 to 3.6 V supply. High impedance TTL compatible inputs significantly reduce current loading to input drivers while TTL compatible outputs offer improved switching noise performance. A V_I specification of 5.5 V allows MC74LCX245 inputs to be safely driven from 5 V devices. The MC74LCX245 is suitable for memory address driving and all TTL level bus oriented transceiver applications.

Current drive capability is 24 mA at both A and B ports. The Transmit/Receive (T/\bar{R}) input determines the direction of data flow through the bi-directional transceiver. Transmit (active-HIGH) enables data from A ports to B ports; Receive (active-LOW) enables data from B to A ports. The Output Enable input, when HIGH, disables both A and B ports by placing them in a HIGH Z condition.

Features

- Designed for 2.3 to 3.6 V V_{CC} Operation
- 5 V Tolerant – Interface Capability With 5 V TTL Logic
- Supports Live Insertion and Withdrawal
- I_{OFF} Specification Guarantees High Impedance When $V_{CC} = 0$ V
- LVTTL Compatible
- LVCMOS Compatible
- 24 mA Balanced Output Sink and Source Capability
- Near Zero Static Supply Current in All Three Logic States (10 μ A) Substantially Reduces System Power Requirements
- Latchup Performance Exceeds 500 mA
- ESD Performance: Human Body Model >2000 V
Machine Model >200 V
- Pb-Free Packages are Available*



ON Semiconductor®

<http://onsemi.com>

MARKING DIAGRAMS

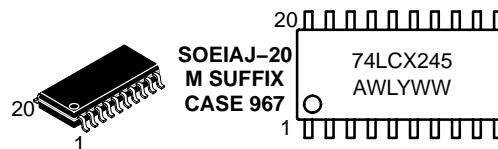
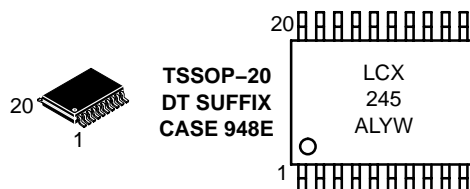
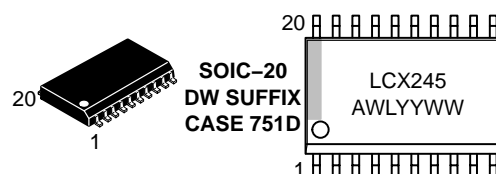

A = Assembly Location
L, WL = Wafer Lot
Y, YY = Year
W, WW = Work Week

ORDERING INFORMATION

See detailed ordering and shipping information in the package dimensions section on page 3 of this data sheet.

*For additional information on our Pb-Free strategy and soldering details, please download the ON Semiconductor Soldering and Mounting Techniques Reference Manual, SOLDERRM/D.

MC74LCX245

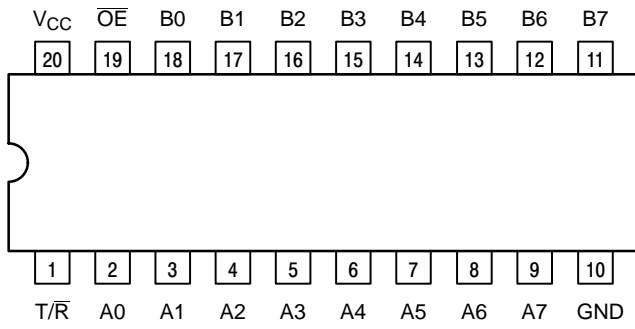

Figure 1. Pinout (Top View)

PIN NAMES

PINS	FUNCTION
\overline{OE}	Output Enable Input
T/\overline{R}	Transmit/Receive Input
A0–A7	Side A 3–State Inputs or 3–State Outputs
B0–B7	Side B 3–State Inputs or 3–State Outputs

TRUTH TABLE

INPUTS		OPERATING MODE Non-Inverting
\overline{OE}	T/\overline{R}	
L	L	B Data to A Bus
L	H	A Data to B Bus
H	X	Z

H = High Voltage Level
 L = Low Voltage Level
 Z = High Impedance State
 X = High or Low Voltage Level and Transitions are Acceptable
 For I_{CC} reasons, Do Not Float Inputs

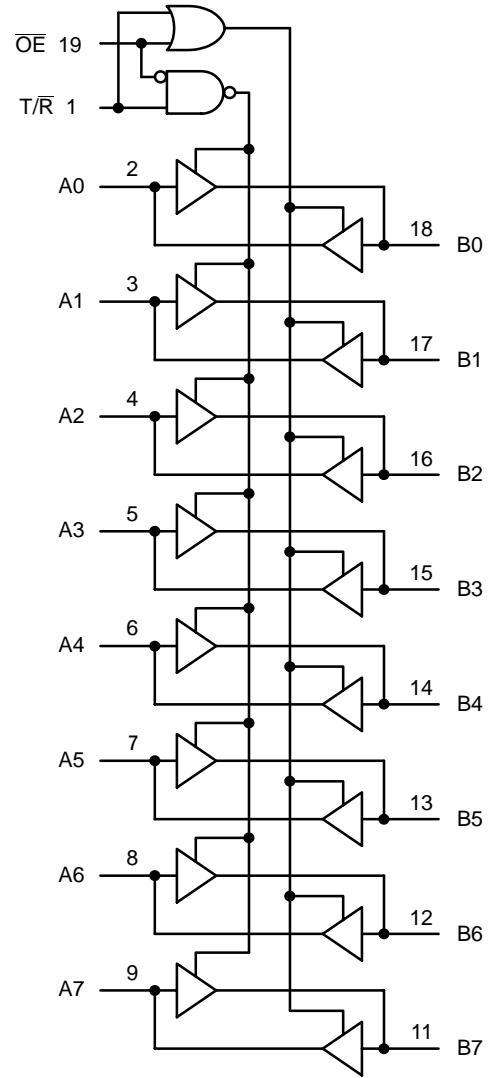

Figure 2. Logic Diagram

MC74LCX245

MAXIMUM RATINGS

Symbol	Parameter	Value	Condition	Unit
V _{CC}	DC Supply Voltage	-0.5 to +7.0		V
V _I	DC Input Voltage	-0.5 ≤ V _I ≤ +7.0		V
V _O	DC Output Voltage	-0.5 ≤ V _O ≤ +7.0	Output in 3-State	V
		-0.5 ≤ V _O ≤ V _{CC} + 0.5	Output in HIGH or LOW State (Note 1)	V
I _{IK}	DC Input Diode Current	-50	V _I < GND	mA
I _{OK}	DC Output Diode Current	-50	V _O < GND	mA
		+50	V _O > V _{CC}	mA
I _O	DC Output Source/Sink Current	±50		mA
I _{CC}	DC Supply Current Per Supply Pin	±100		mA
I _{GND}	DC Ground Current Per Ground Pin	±100		mA
T _{STG}	Storage Temperature Range	-65 to +150		°C

Maximum ratings are those values beyond which device damage can occur. Maximum ratings applied to the device are individual stress limit values (not normal operating conditions) and are not valid simultaneously. If these limits are exceeded, device functional operation is not implied, damage may occur and reliability may be affected.

1. I_O absolute maximum rating must be observed.

RECOMMENDED OPERATING CONDITIONS

Symbol	Parameter	Min	Typ	Max	Unit	
V _{CC}	Supply Voltage	Operating	2.0	2.5, 3.3	3.6	V
		Data Retention Only	1.5	2.5, 3.3	3.6	
V _I	Input Voltage	0		5.5	V	
V _O	Output Voltage	(HIGH or LOW State)	0		V _{CC}	V
		(3-State)	0		5.5	
I _{OH}	HIGH Level Output Current	V _{CC} = 3.0 V - 3.6 V			- 24	mA
		V _{CC} = 2.7 V - 3.0 V			- 12	
		V _{CC} = 2.3 V - 2.7 V			- 8	
I _{OL}	LOW Level Output Current	V _{CC} = 3.0 V - 3.6 V			+ 24	mA
		V _{CC} = 2.7 V - 3.0 V			+ 12	
		V _{CC} = 2.3 V - 2.7 V			+ 8	
T _A	Operating Free-Air Temperature	-40		+85	°C	
Δt/ΔV	Input Transition Rise or Fall Rate, V _{IN} from 0.8 V to 2.0 V, V _{CC} = 3.0 V	0		10	ns/V	

ORDERING INFORMATION

Device	Package	Shipping [†]
MC74LCX245DW	SOIC-20	38 Units / Rail
MC74LCX245DWG	SOIC-20 (Pb-Free)	38 Units / Rail
MC74LCX245DWR2	SOIC-20	1000 Tape & Reel
MC74LCX245DR2G	SOIC-20 (Pb-Free)	1000 Tape & Reel
MC74LCX245DT	TSSOP-20*	75 Units / Rail
MC74LCX245DTR2	TSSOP-20*	2000 Tape & Reel
MC74LCX245M	SOEIAJ-20	40 Units / Rail
MC74LCX245MEL	SOEIAJ-20	2000 Tape & Reel

[†]For information on tape and reel specifications, including part orientation and tape sizes, please refer to our Tape and Reel Packaging Specifications Brochure, BRD8011/D.

*This package is inherently Pb-Free.

MC74LCX245

DC ELECTRICAL CHARACTERISTICS

Symbol	Characteristic	Condition	T _A = -40°C to +85°C		Unit
			Min	Max	
V _{IH}	HIGH Level Input Voltage (Note 2)	2.3 V ≤ V _{CC} ≤ 2.7 V	1.7		V
		2.7 V ≤ V _{CC} ≤ 3.6 V	2.0		
V _{IL}	LOW Level Input Voltage (Note 2)	2.3 V ≤ V _{CC} ≤ 2.7 V		0.7	V
		2.7 V ≤ V _{CC} ≤ 3.6 V		0.8	
V _{OH}	HIGH Level Output Voltage	2.3 V ≤ V _{CC} ≤ 3.6 V; I _{OL} = 100 μA	V _{CC} - 0.2		V
		V _{CC} = 2.3 V; I _{OH} = -8 mA	1.8		
		V _{CC} = 2.7 V; I _{OH} = -12 mA	2.2		
		V _{CC} = 3.0 V; I _{OH} = -18 mA	2.4		
		V _{CC} = 3.0 V; I _{OH} = -24 mA	2.2		
V _{OL}	LOW Level Output Voltage	2.3 V ≤ V _{CC} ≤ 3.6 V; I _{OL} = 100 μA		0.2	V
		V _{CC} = 2.3 V; I _{OL} = 8 mA		0.6	
		V _{CC} = 2.7 V; I _{OL} = 12 mA		0.4	
		V _{CC} = 3.0 V; I _{OL} = 16 mA		0.4	
		V _{CC} = 3.0 V; I _{OL} = 24 mA		0.55	
I _I	Input Leakage Current	2.3 V ≤ V _{CC} ≤ 3.6 V; 0 V ≤ V _I ≤ 5.5 V		±5	μA
I _{OZ}	3-State Output Current	2.3 ≤ V _{CC} ≤ 3.6 V; 0V ≤ V _O ≤ 5.5 V; V _I = V _{IH} or V _{IL}		±5	μA
I _{OFF}	Power-Off Leakage Current	V _{CC} = 0 V; V _I or V _O = 5.5 V		10	μA
I _{CC}	Quiescent Supply Current	2.3 ≤ V _{CC} ≤ 3.6 V; V _I = GND or V _{CC}		10	μA
		2.3 ≤ V _{CC} ≤ 3.6 V; 3.6 ≤ V _I or V _O ≤ 5.5 V		±10	
ΔI _{CC}	Increase in I _{CC} per Input	2.3 ≤ V _{CC} ≤ 3.6 V; V _{IH} = V _{CC} - 0.6 V		500	μA

2. These values of V_I are used to test DC electrical characteristics only.

AC CHARACTERISTICS t_R = t_F = 2.5 ns; R_L = 500 Ω

Symbol	Parameter	Waveform	Limits						Unit
			T _A = -40°C to +85°C						
			V _{CC} = 3.3 V ± 0.3 V		V _{CC} = 2.7 V		V _{CC} = 2.5 V ± 0.2 V		
			C _L = 50 pF		C _L = 50 pF		C _L = 30 pF		
			Min	Max	Min	Max	Min	Max	
t _{PLH} t _{PHL}	Propagation Delay Input to Output	1	1.5 1.5	7.0 7.0	1.5 1.5	8.0 8.0	1.5 1.5	8.4 8.4	ns
t _{PZH} t _{PZL}	Output Enable Time to High and Low Level	2	1.5 1.5	8.5 8.5	1.5 1.5	9.5 9.5	1.5 1.5	10.5 10.5	
t _{PHZ} t _{PLZ}	Output Disable Time From High and Low Level	2	1.5 1.5	7.5 7.5	1.5 1.5	8.5 8.5	1.5 1.5	9.0 9.0	ns
t _{OSSL} t _{OSSLH}	Output-to-Output Skew (Note 3)			1.0 1.0					

3. Skew is defined as the absolute value of the difference between the actual propagation delay for any two separate outputs of the same device. The specification applies to any outputs switching in the same direction, either HIGH-to-LOW (t_{OSSL}) or LOW-to-HIGH (t_{OSSLH}); parameter guaranteed by design.

MC74LCX245

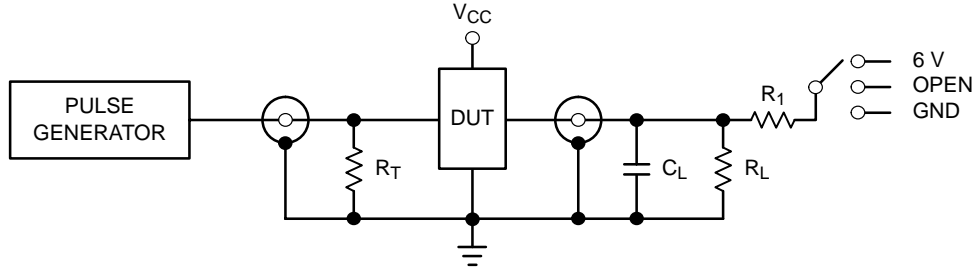

TEST	SWITCH
t_{PLH} , t_{PHL}	Open
t_{PZL} , t_{PLZ}	6 V at $V_{CC} = 3.3 \pm 0.3$ V 6 V at $V_{CC} = 2.5 \pm 0.2$ V
Open Collector/Drain t_{PLH} and t_{PHL}	6 V
t_{PZH} , t_{PHZ}	GND

$C_L = 50$ pF at $V_{CC} = 3.3 \pm 0.3$ V or equivalent (includes jig and probe capacitance)

$C_L = 30$ pF at $V_{CC} = 2.5 \pm 0.2$ V or equivalent (includes jig and probe capacitance)

$R_L = R_1 = 500 \Omega$ or equivalent

$R_T = Z_{OUT}$ of pulse generator (typically 50Ω)

Figure 4. Test Circuit

MC74LCX245

PACKAGE DIMENSIONS

SOIC-20
DW SUFFIX
CASE 751D-05
ISSUE G

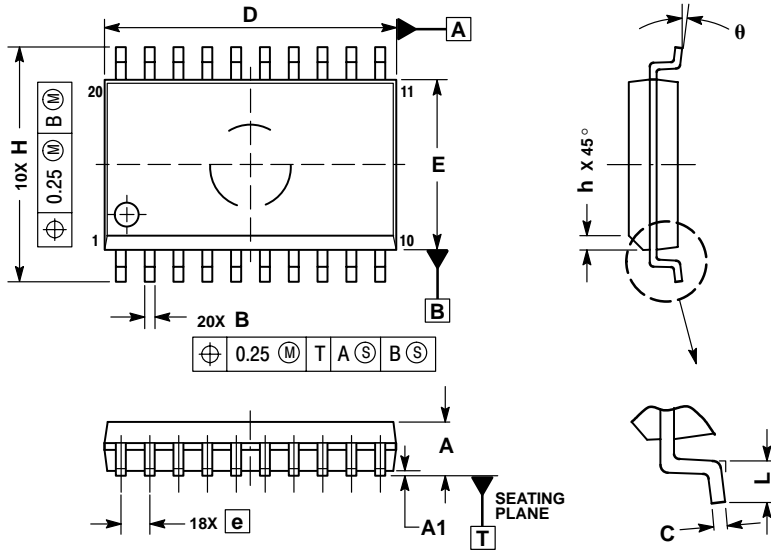

NOTES:

1. DIMENSIONS ARE IN MILLIMETERS.
2. INTERPRET DIMENSIONS AND TOLERANCES PER ASME Y14.5M, 1994.
3. DIMENSIONS D AND E DO NOT INCLUDE MOLD PROTRUSION.
4. MAXIMUM MOLD PROTRUSION 0.15 PER SIDE.
5. DIMENSION B DOES NOT INCLUDE DAMBAR PROTRUSION. ALLOWABLE PROTRUSION SHALL BE 0.13 TOTAL IN EXCESS OF B DIMENSION AT MAXIMUM MATERIAL CONDITION.

DIM	MILLIMETERS	
	MIN	MAX
A	2.35	2.65
A1	0.10	0.25
B	0.35	0.49
C	0.23	0.32
D	12.65	12.95
E	7.40	7.60
e	1.27 BSC	
H	10.05	10.55
h	0.25	0.75
L	0.50	0.90
theta	0°	7°

TSSOP-20
DT SUFFIX
CASE 948E-02
ISSUE B

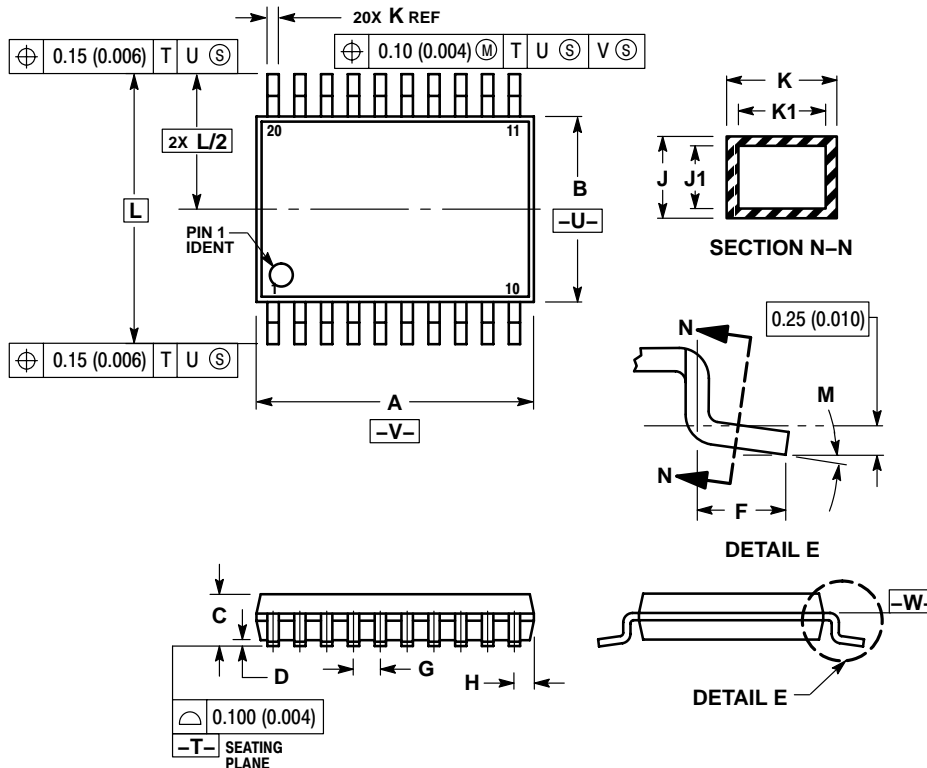

NOTES:

1. DIMENSIONING AND TOLERANCING PER ANSI Y14.5M, 1982.
2. CONTROLLING DIMENSION: MILLIMETER.
3. DIMENSION A DOES NOT INCLUDE MOLD FLASH, PROTRUSIONS OR GATE BURRS. MOLD FLASH OR GATE BURRS SHALL NOT EXCEED 0.15 (0.006) PER SIDE.
4. DIMENSION B DOES NOT INCLUDE INTERLEAD FLASH OR PROTRUSION. INTERLEAD FLASH OR PROTRUSION SHALL NOT EXCEED 0.25 (0.010) PER SIDE.
5. DIMENSION K DOES NOT INCLUDE DAMBAR PROTRUSION. ALLOWABLE DAMBAR PROTRUSION SHALL BE 0.08 (0.003) TOTAL IN EXCESS OF THE K DIMENSION AT MAXIMUM MATERIAL CONDITION.
6. TERMINAL NUMBERS ARE SHOWN FOR REFERENCE ONLY.
7. DIMENSION A AND B ARE TO BE DETERMINED AT DATUM PLANE -W-.

DIM	MILLIMETERS		INCHES	
	MIN	MAX	MIN	MAX
A	6.40	6.60	0.252	0.260
B	4.30	4.50	0.169	0.177
C	---	1.20	---	0.047
D	0.05	0.15	0.002	0.006
F	0.50	0.75	0.020	0.030
G	0.65 BSC		0.026 BSC	
H	0.27	0.37	0.011	0.015
J	0.09	0.20	0.004	0.008
J1	0.09	0.16	0.004	0.006
K	0.19	0.30	0.007	0.012
K1	0.19	0.25	0.007	0.010
L	6.40 BSC		0.252 BSC	
M	0°	8°	0°	8°

MC74LCX245

PACKAGE DIMENSIONS

SOEIAJ-20
M SUFFIX
CASE 967-01
ISSUE O

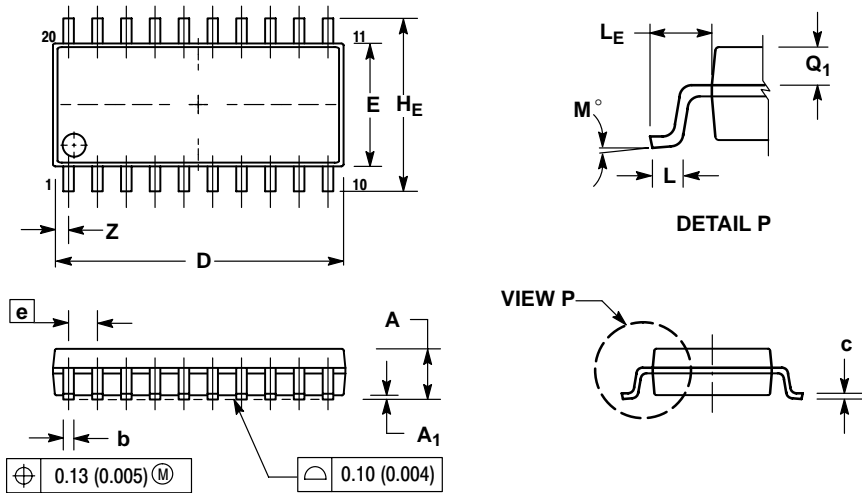

NOTES:

1. DIMENSIONING AND TOLERANCING PER ANSI Y14.5M, 1982.
2. CONTROLLING DIMENSION: MILLIMETER.
3. DIMENSIONS D AND E DO NOT INCLUDE MOLD FLASH OR PROTRUSIONS AND ARE MEASURED AT THE PARTING LINE. MOLD FLASH OR PROTRUSIONS SHALL NOT EXCEED 0.15 (0.006) PER SIDE.
4. TERMINAL NUMBERS ARE SHOWN FOR REFERENCE ONLY.
5. THE LEAD WIDTH DIMENSION (b) DOES NOT INCLUDE DAMBAR PROTRUSION. ALLOWABLE DAMBAR PROTRUSION SHALL BE 0.08 (0.003) TOTAL IN EXCESS OF THE LEAD WIDTH DIMENSION AT MAXIMUM MATERIAL CONDITION. DAMBAR CANNOT BE LOCATED ON THE LOWER RADIUS OR THE FOOT. MINIMUM SPACE BETWEEN PROTRUSIONS AND ADJACENT LEAD TO BE 0.46 (0.018).

DIM	MILLIMETERS		INCHES	
	MIN	MAX	MIN	MAX
A	---	2.05	---	0.081
A ₁	0.05	0.20	0.002	0.008
b	0.35	0.50	0.014	0.020
c	0.18	0.27	0.007	0.011
D	12.35	12.80	0.486	0.504
E	5.10	5.45	0.201	0.215
e	1.27 BSC		0.050 BSC	
H _E	7.40	8.20	0.291	0.323
L	0.50	0.85	0.020	0.033
L _E	1.10	1.50	0.043	0.059
M	0°	10°	0°	10°
Q ₁	0.70	0.90	0.028	0.035
Z	---	0.81	---	0.032

ON Semiconductor and  are registered trademarks of Semiconductor Components Industries, LLC (SCILLC). SCILLC reserves the right to make changes without further notice to any products herein. SCILLC makes no warranty, representation or guarantee regarding the suitability of its products for any particular purpose, nor does SCILLC assume any liability arising out of the application or use of any product or circuit, and specifically disclaims any and all liability, including without limitation special, consequential or incidental damages. "Typical" parameters which may be provided in SCILLC data sheets and/or specifications can and do vary in different applications and actual performance may vary over time. All operating parameters, including "Typicals" must be validated for each customer application by customer's technical experts. SCILLC does not convey any license under its patent rights nor the rights of others. SCILLC products are not designed, intended, or authorized for use as components in systems intended for surgical implant into the body, or other applications intended to support or sustain life, or for any other application in which the failure of the SCILLC product could create a situation where personal injury or death may occur. Should Buyer purchase or use SCILLC products for any such unintended or unauthorized application, Buyer shall indemnify and hold SCILLC and its officers, employees, subsidiaries, affiliates, and distributors harmless against all claims, costs, damages, and expenses, and reasonable attorney fees arising out of, directly or indirectly, any claim of personal injury or death associated with such unintended or unauthorized use, even if such claim alleges that SCILLC was negligent regarding the design or manufacture of the part. SCILLC is an Equal Opportunity/Affirmative Action Employer. This literature is subject to all applicable copyright laws and is not for resale in any manner.

PUBLICATION ORDERING INFORMATION

LITERATURE FULFILLMENT:

Literature Distribution Center for ON Semiconductor
P.O. Box 61312, Phoenix, Arizona 85082-1312 USA
Phone: 480-829-7710 or 800-344-3860 Toll Free USA/Canada
Fax: 480-829-7709 or 800-344-3867 Toll Free USA/Canada
Email: orderlit@onsemi.com

N. American Technical Support: 800-282-9855 Toll Free USA/Canada

Japan: ON Semiconductor, Japan Customer Focus Center
2-9-1 Kamimeguro, Meguro-ku, Tokyo, Japan 153-0051
Phone: 81-3-5773-3850

ON Semiconductor Website: <http://onsemi.com>

Order Literature: <http://www.onsemi.com/litorder>

For additional information, please contact your local Sales Representative.