

IRG4PC50UDPbF

INSULATED GATE BIPOLAR TRANSISTOR WITH ULTRAFAST SOFT RECOVERY DIODE UltraFast CoPack IGBT

Features

- UltraFast: Optimized for high operating frequencies 8-40 kHz in hard switching, >200 kHz in resonant mode
- Generation 4 IGBT design provides tighter parameter distribution and higher efficiency than Generation 3
- IGBT co-packaged with HEXFRED™ ultrafast, ultra-soft-recovery anti-parallel diodes for use in bridge configurations
- Industry standard TO-247AC package
- Lead-Free

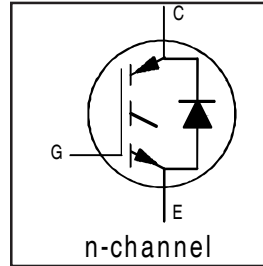

| |
|-----------------------------|
| $V_{CES} = 600V$ |
| $V_{CE(on) typ.} = 1.65V$ |
| @ $V_{GE} = 15V, I_C = 27A$ |

Benefits

- Generation 4 IGBT's offer highest efficiencies available
- IGBT's optimized for specific application conditions
- HEXFRED diodes optimized for performance with IGBT's. Minimized recovery characteristics require less/no snubbing
- Designed to be a "drop-in" replacement for equivalent industry-standard Generation 3 IR IGBT's

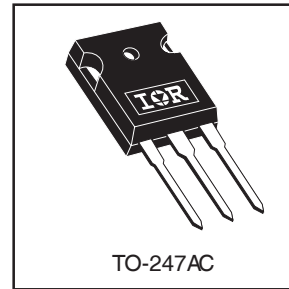

Absolute Maximum Ratings

| | Parameter | Max. | Units |
|---------------------------|------------------------------------|-----------------------------------|-------|
| V_{CES} | Collector-to-Emitter Voltage | 600 | V |
| $I_C @ T_C = 25^\circ C$ | Continuous Collector Current | 55 | A |
| $I_C @ T_C = 100^\circ C$ | Continuous Collector Current | 27 | |
| I_{CM} | Pulsed Collector Current ① | 220 | |
| I_{LM} | Clamped Inductive Load Current ② | 220 | |
| $I_F @ T_C = 100^\circ C$ | Diode Continuous Forward Current | 25 | |
| I_{FM} | Diode Maximum Forward Current | 220 | |
| V_{GE} | Gate-to-Emitter Voltage | ± 20 | V |
| $P_D @ T_C = 25^\circ C$ | Maximum Power Dissipation | 200 | W |
| $P_D @ T_C = 100^\circ C$ | Maximum Power Dissipation | 78 | |
| T_J | Operating Junction and | -55 to +150 | °C |
| T_{STG} | Storage Temperature Range | | |
| | Soldering Temperature, for 10 sec. | 300 (0.063 in. (1.6mm) from case) | |
| | Mounting Torque, 6-32 or M3 Screw. | 10 lbf•in (1.1 N•m) | |

Thermal Resistance

| | Parameter | Min. | Typ. | Max. | Units |
|-----------------|---|-------|----------|-------|--------|
| $R_{\theta JC}$ | Junction-to-Case - IGBT | ----- | ----- | 0.64 | °C/W |
| $R_{\theta JC}$ | Junction-to-Case - Diode | ----- | ----- | 0.83 | |
| $R_{\theta CS}$ | Case-to-Sink, flat, greased surface | ----- | 0.24 | ----- | |
| $R_{\theta JA}$ | Junction-to-Ambient, typical socket mount | ----- | ----- | 40 | |
| Wt | Weight | ----- | 6 (0.21) | ----- | g (oz) |

IRG4PC50UDPbF

Electrical Characteristics @ $T_J = 25^\circ\text{C}$ (unless otherwise specified)

| | Parameter | Min. | Typ. | Max. | Units | Conditions |
|---------------------------------|---|------|------|-----------|----------------------|---|
| $V_{(BR)CES}$ | Collector-to-Emitter Breakdown Voltage ^③ | 600 | ---- | ---- | V | $V_{GE} = 0V, I_C = 250\mu A$ |
| $\Delta V_{(BR)CES}/\Delta T_J$ | Temperature Coeff. of Breakdown Voltage | ---- | 0.60 | ---- | V/ $^\circ\text{C}$ | $V_{GE} = 0V, I_C = 1.0mA$ |
| $V_{CE(on)}$ | Collector-to-Emitter Saturation Voltage | ---- | 1.65 | 2.0 | V | $I_C = 27A$ $I_C = 55A$ $I_C = 27A, T_J = 150^\circ\text{C}$ $V_{GE} = 15V$ See Fig. 2, 5 |
| | | ---- | 2.0 | ---- | | |
| | | ---- | 1.6 | ---- | | |
| $V_{GE(th)}$ | Gate Threshold Voltage | 3.0 | ---- | 6.0 | | $V_{CE} = V_{GE}, I_C = 250\mu A$ |
| $\Delta V_{GE(th)}/\Delta T_J$ | Temperature Coeff. of Threshold Voltage | ---- | -13 | ---- | mV/ $^\circ\text{C}$ | $V_{CE} = V_{GE}, I_C = 250\mu A$ |
| g_{fe} | Forward Transconductance ^④ | 16 | 24 | ---- | S | $V_{CE} = 100V, I_C = 27A$ |
| I_{CES} | Zero Gate Voltage Collector Current | ---- | ---- | 250 | μA | $V_{GE} = 0V, V_{CE} = 600V$ $V_{GE} = 0V, V_{CE} = 600V, T_J = 150^\circ\text{C}$ |
| | | ---- | ---- | 6500 | | |
| V_{FM} | Diode Forward Voltage Drop | ---- | 1.3 | 1.7 | V | $I_C = 25A$ $I_C = 25A, T_J = 150^\circ\text{C}$ See Fig. 13 |
| | | ---- | 1.2 | 1.5 | | |
| I_{GES} | Gate-to-Emitter Leakage Current | ---- | ---- | ± 100 | nA | $V_{GE} = \pm 20V$ |

Switching Characteristics @ $T_J = 25^\circ\text{C}$ (unless otherwise specified)

| | Parameter | Min. | Typ. | Max. | Units | Conditions |
|------------------|---|------|------|------|------------|---|
| Q_g | Total Gate Charge (turn-on) | ---- | 180 | 270 | | $I_C = 27A$ |
| Q_{ge} | Gate - Emitter Charge (turn-on) | ---- | 25 | 38 | nC | $V_{CC} = 400V$ See Fig. 8 |
| Q_{gc} | Gate - Collector Charge (turn-on) | ---- | 61 | 90 | | |
| $t_{d(on)}$ | Turn-On Delay Time | ---- | 46 | ---- | | $V_{GE} = 15V$ $T_J = 25^\circ\text{C}$ |
| t_r | Rise Time | ---- | 25 | ---- | ns | $I_C = 27A, V_{CC} = 480V$ |
| $t_{d(off)}$ | Turn-Off Delay Time | ---- | 140 | 230 | | $V_{GE} = 15V, R_G = 5.0\Omega$ Energy losses include "tail" and diode reverse recovery. See Fig. 9, 10, 11, 18 |
| t_f | Fall Time | ---- | 74 | 110 | | |
| E_{on} | Turn-On Switching Loss | ---- | 0.99 | ---- | | $T_J = 150^\circ\text{C}$, See Fig. 9, 10, 11, 18 $I_C = 27A, V_{CC} = 480V$ |
| E_{off} | Turn-Off Switching Loss | ---- | 0.59 | ---- | mJ | |
| E_{is} | Total Switching Loss | ---- | 1.58 | 1.9 | | $V_{GE} = 15V, R_G = 5.0\Omega$ Energy losses include "tail" and diode reverse recovery. Measured 5mm from package $V_{GE} = 0V$ |
| $t_{d(on)}$ | Turn-On Delay Time | ---- | 44 | ---- | ns | |
| t_r | Rise Time | ---- | 27 | ---- | | $V_{CC} = 30V$ See Fig. 7 |
| $t_{d(off)}$ | Turn-Off Delay Time | ---- | 240 | ---- | | |
| t_f | Fall Time | ---- | 130 | ---- | | $f = 1.0MHz$ $T_J = 25^\circ\text{C}$ See Fig. $T_J = 125^\circ\text{C}$ 14 $I_F = 25A$ |
| E_{is} | Total Switching Loss | ---- | 2.3 | ---- | mJ | |
| L_E | Internal Emitter Inductance | ---- | 13 | ---- | nH | $T_J = 25^\circ\text{C}$ See Fig. $T_J = 125^\circ\text{C}$ 16 |
| C_{ies} | Input Capacitance | ---- | 4000 | ---- | | |
| C_{oes} | Output Capacitance | ---- | 250 | ---- | pF | $V_R = 200V$ $di/dt 200A/\mu s$ |
| C_{res} | Reverse Transfer Capacitance | ---- | 52 | ---- | | |
| t_{rr} | Diode Reverse Recovery Time | ---- | 50 | 75 | ns | $T_J = 25^\circ\text{C}$ See Fig. $T_J = 125^\circ\text{C}$ 16 |
| | | ---- | 105 | 160 | | |
| I_{rr} | Diode Peak Reverse Recovery Current | ---- | 4.5 | 10 | A | $T_J = 25^\circ\text{C}$ See Fig. $T_J = 125^\circ\text{C}$ 15 |
| | | ---- | 8.0 | 15 | | |
| Q_{rr} | Diode Reverse Recovery Charge | ---- | 112 | 375 | nC | $T_J = 25^\circ\text{C}$ See Fig. $T_J = 125^\circ\text{C}$ 16 |
| | | ---- | 420 | 1200 | | |
| $di_{(rec)M}/dt$ | Diode Peak Rate of Fall of Recovery During t_{rr} | ---- | 250 | ---- | A/ μs | $T_J = 25^\circ\text{C}$ $T_J = 125^\circ\text{C}$ |
| | | ---- | 160 | ---- | | |
| | | | | | | |

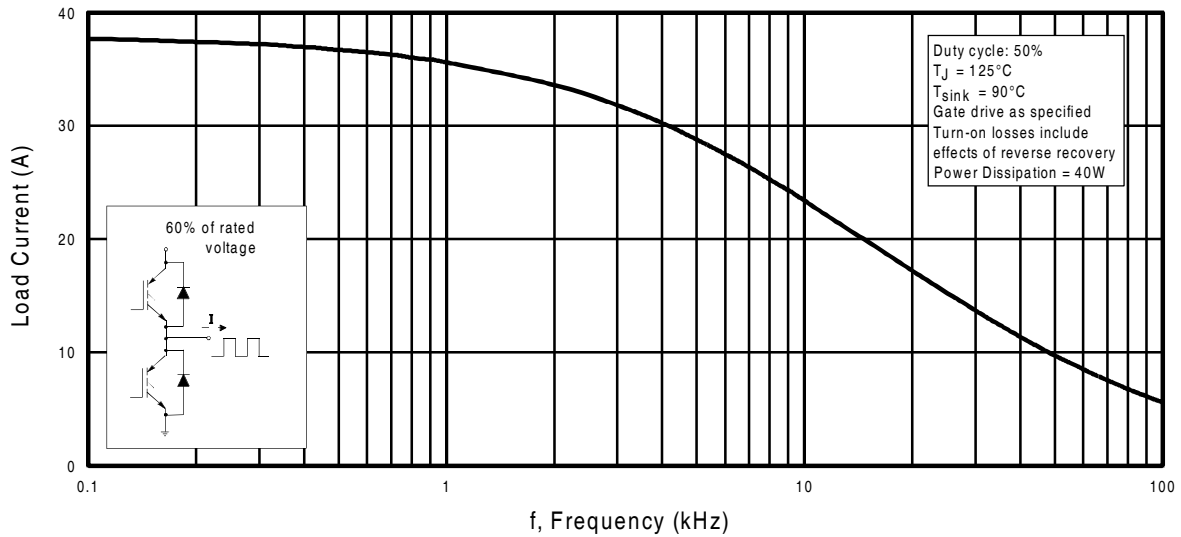

Fig. 1 - Typical Load Current vs. Frequency
 (Load Current = I_{RMS} of fundamental)

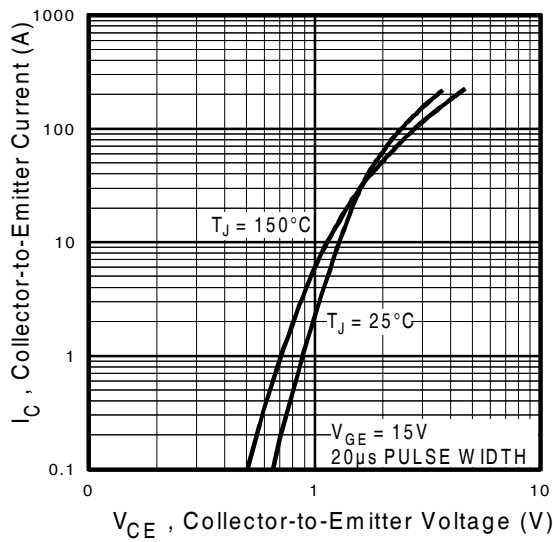

Fig. 2 - Typical Output Characteristics

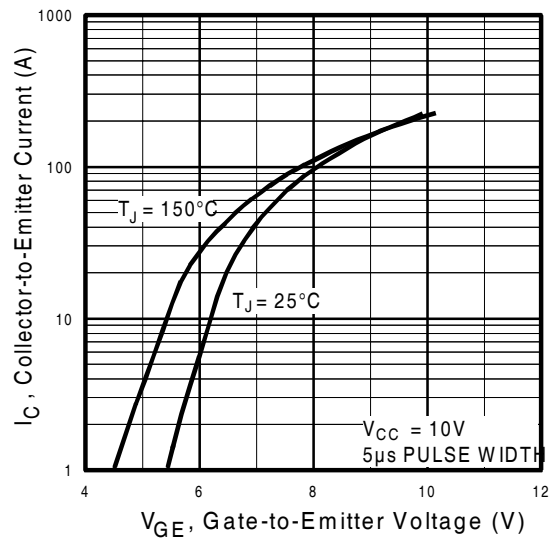

Fig. 3 - Typical Transfer Characteristics

IRG4PC50UDPbF

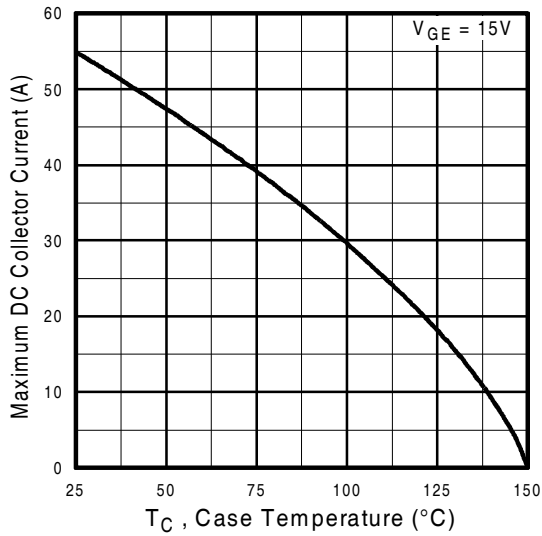

Fig. 4 - Maximum Collector Current vs. Case Temperature

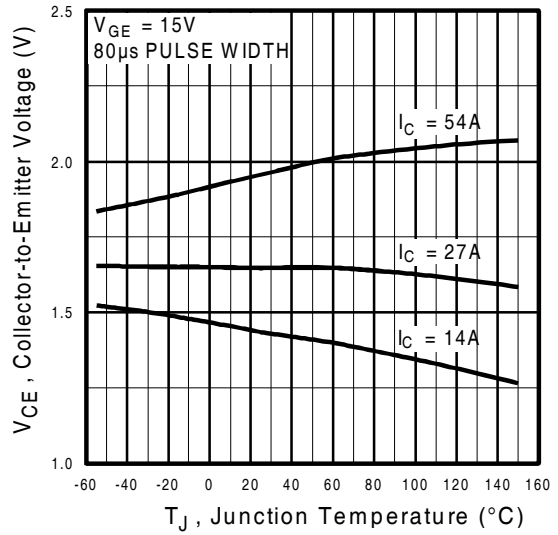

Fig. 5 - Typical Collector-to-Emitter Voltage vs. Junction Temperature

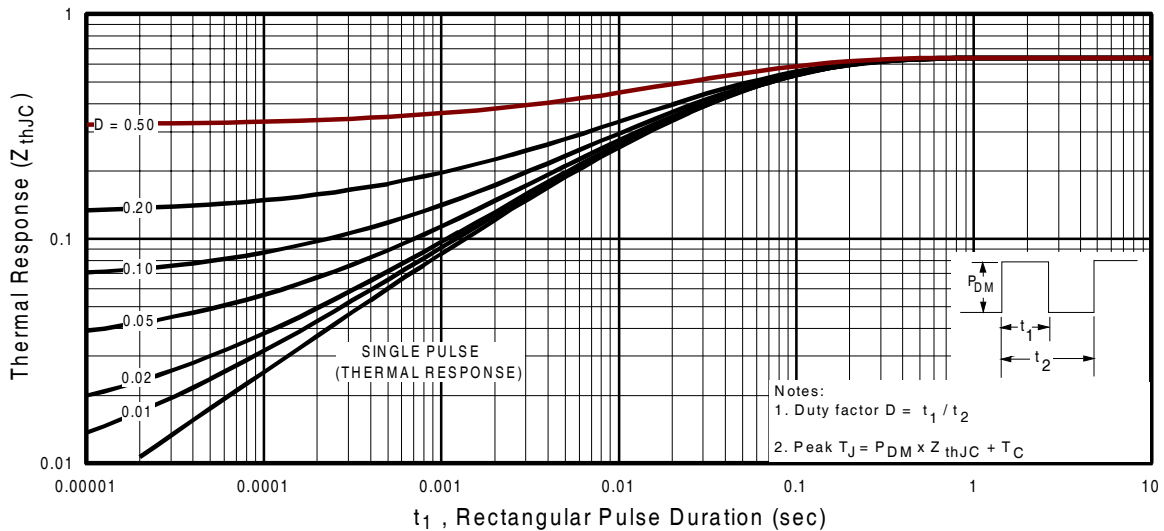

Fig. 6 - Maximum IGBT Effective Transient Thermal Impedance, Junction-to-Case

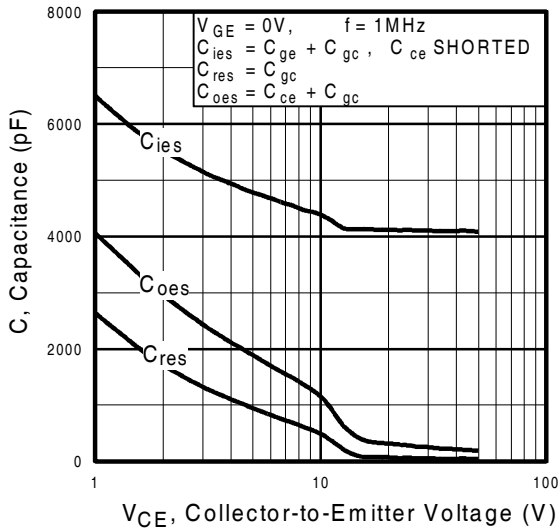

Fig. 7 - Typical Capacitance vs. Collector-to-Emitter Voltage

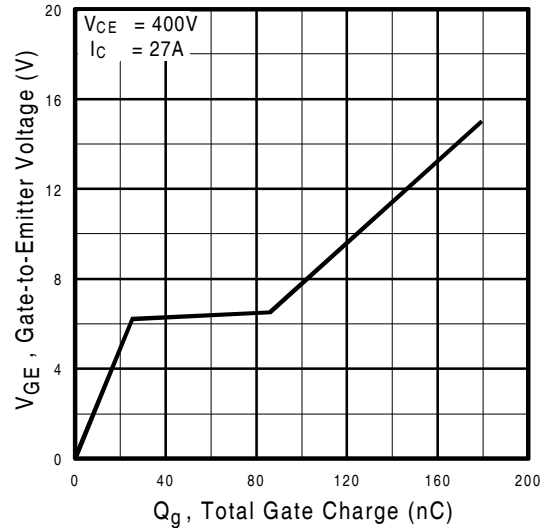

Fig. 8 - Typical Gate Charge vs. Gate-to-Emitter Voltage

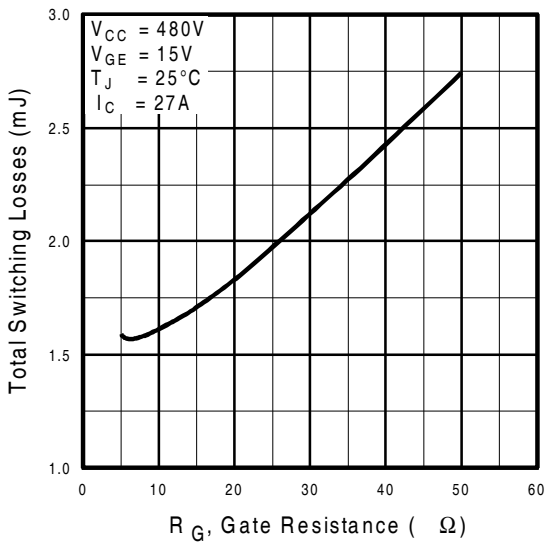

Fig. 9 - Typical Switching Losses vs. Gate Resistance

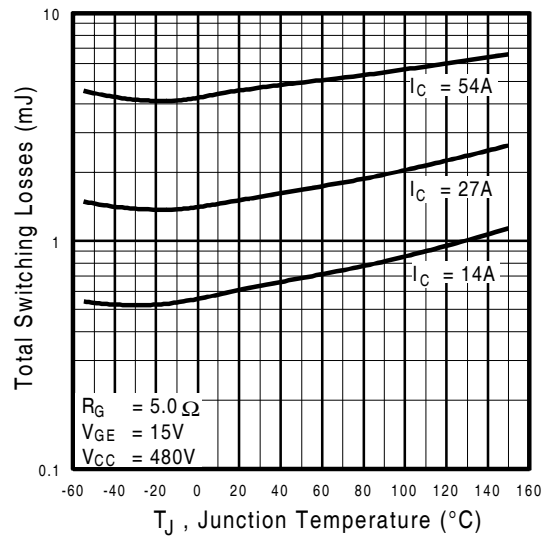

Fig. 10 - Typical Switching Losses vs. Junction Temperature

IRG4PC50UDPbF

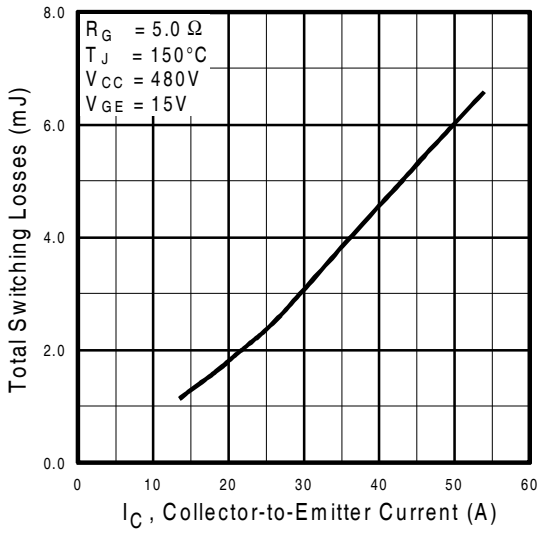

Fig. 11 - Typical Switching Losses vs. Collector-to-Emitter Current

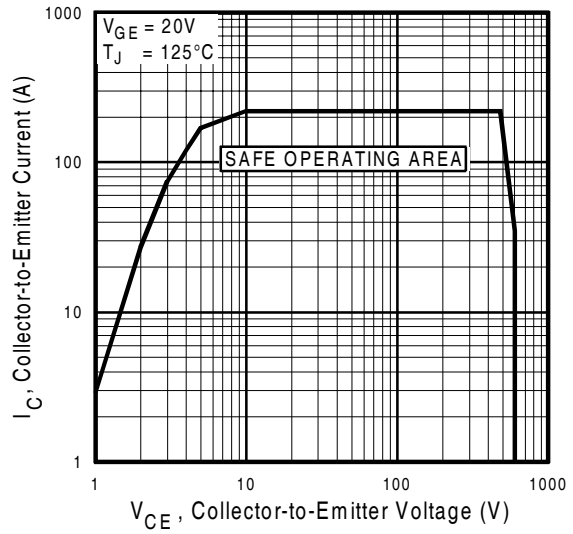

Fig. 12 - Turn-Off SOA

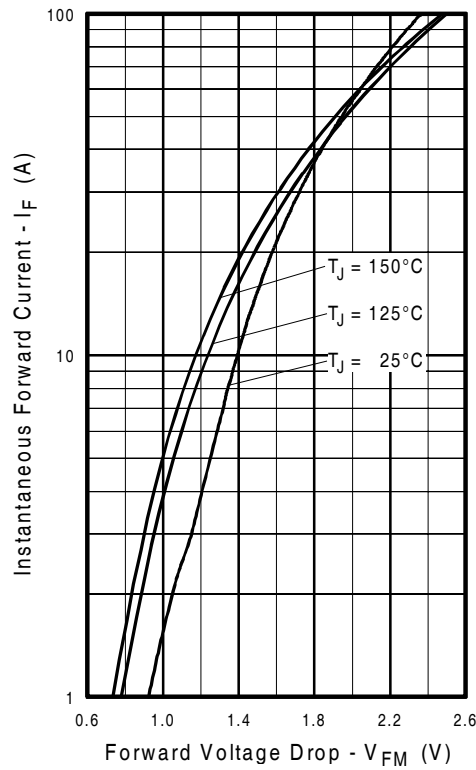

Fig. 13 - Maximum Forward Voltage Drop vs. Instantaneous Forward Current

IRG4PC50UDPbF

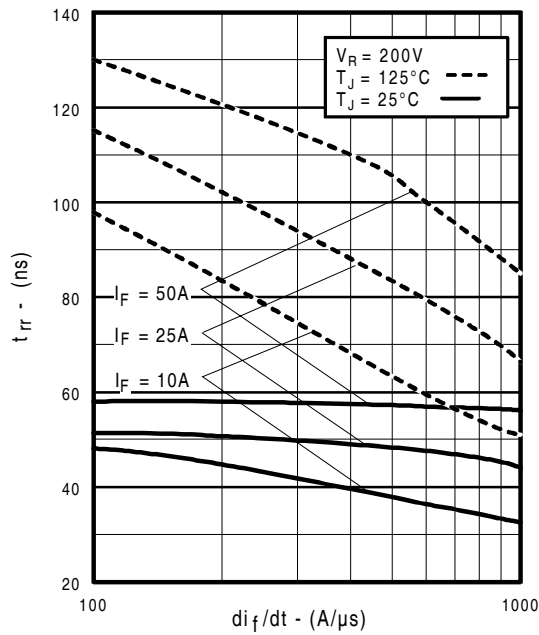

Fig. 14 - Typical Reverse Recovery vs. di_f/dt

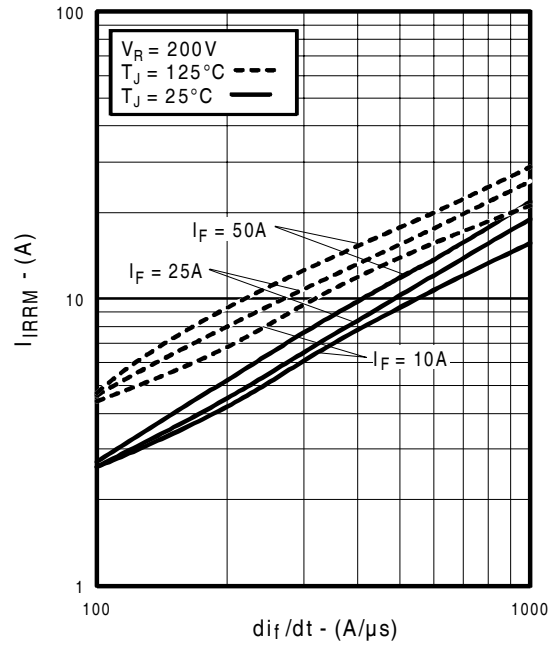

Fig. 15 - Typical Recovery Current vs. di_f/dt

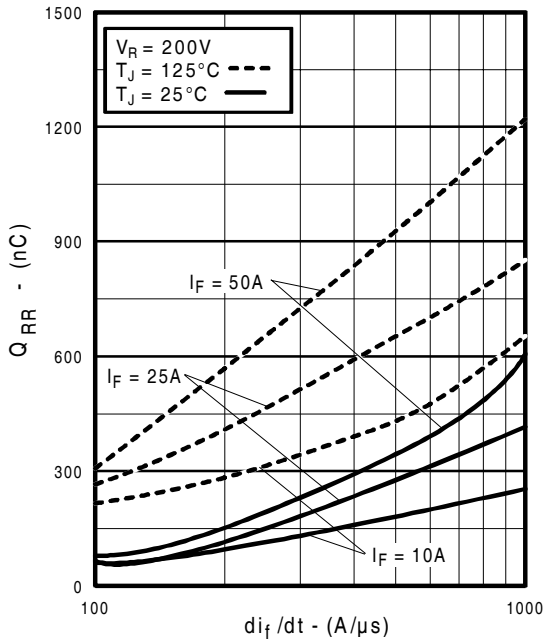

Fig. 16 - Typical Stored Charge vs. di_f/dt

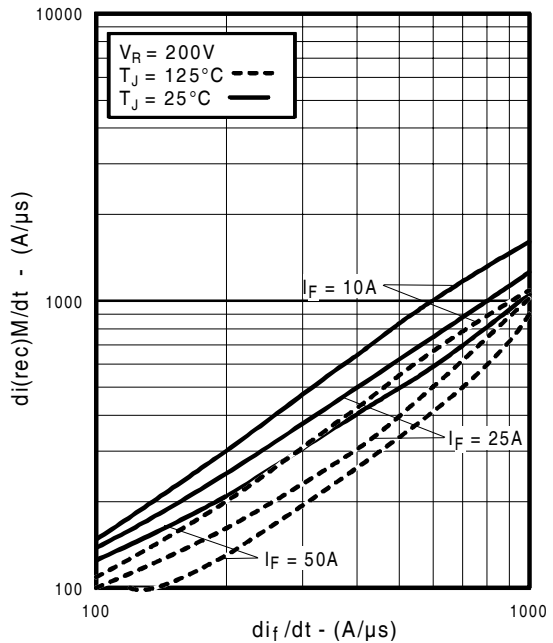

Fig. 17 - Typical $di_{(rec)M}/dt$ vs. di_f/dt

IRG4PC50UDPbF

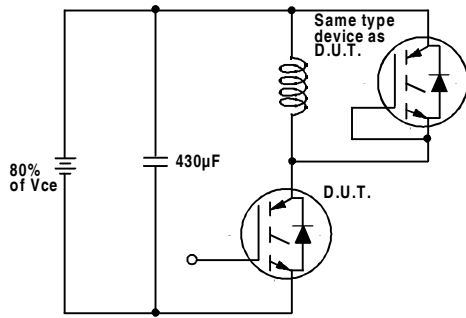

Fig. 18a - Test Circuit for Measurement of I_{LM} , E_{on} , $E_{off}(\text{diode})$, t_{rr} , Q_{rr} , I_{rr} , $t_{d(on)}$, t_r , $t_{d(off)}$, t_f

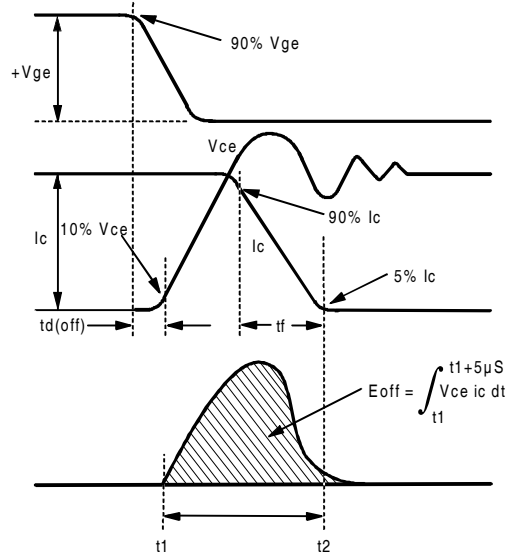

Fig. 18b - Test Waveforms for Circuit of Fig. 18a, Defining E_{off} , $t_{d(off)}$, t_f

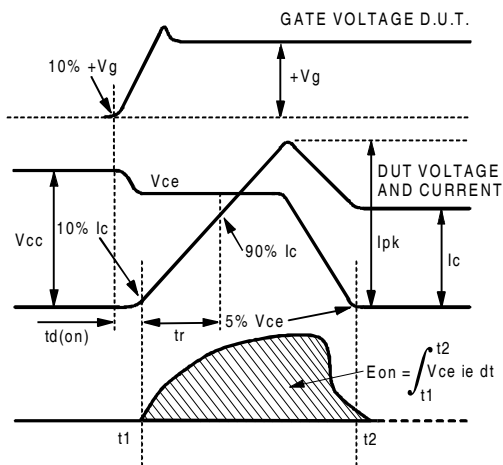

Fig. 18c - Test Waveforms for Circuit of Fig. 18a, Defining E_{on} , $t_{d(on)}$, t_r

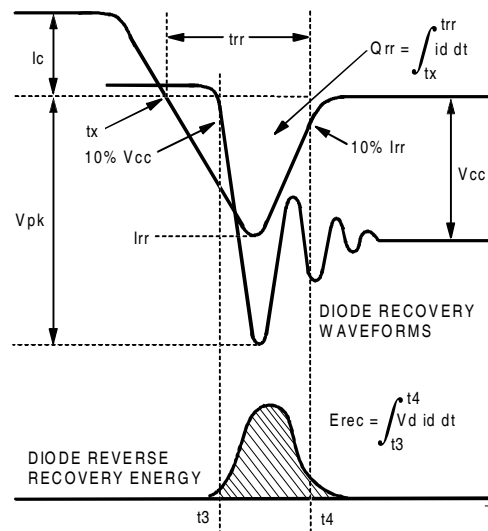

Fig. 18d - Test Waveforms for Circuit of Fig. 18a, Defining E_{rec} , t_{rr} , Q_{rr} , I_{rr}

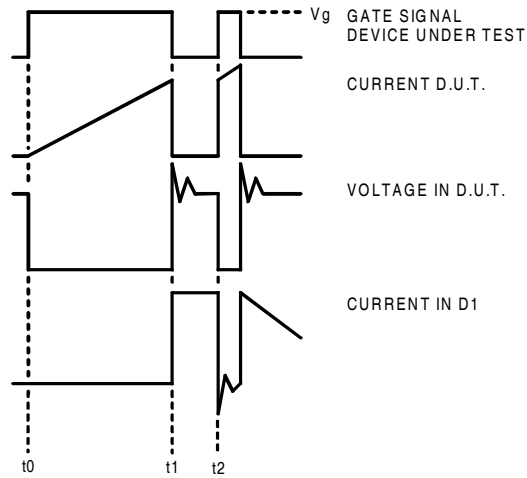

Figure 18e. Macro Waveforms for Figure 18a's Test Circuit

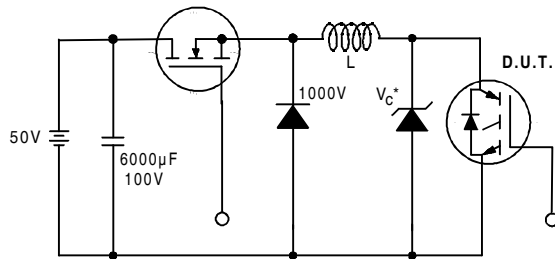

Figure 19. Clamped Inductive Load Test Circuit

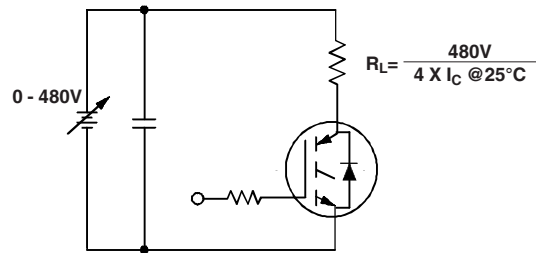

Figure 20. Pulsed Collector Current Test Circuit

IRG4PC50UDPbF

Notes:

- ① Repetitive rating: $V_{GE} = 20V$; pulse width limited by maximum junction temperature (figure 20)
- ② $V_{CC} = 80\%(V_{CES})$, $V_{GE} = 20V$, $L = 10\mu H$, $R_G = 5.0\Omega$ (figure 19)
- ③ Pulse width $\leq 80\mu s$; duty factor $\leq 0.1\%$.
- ④ Pulse width $5.0\mu s$, single shot.

TO-247AC Package Outline

Dimensions are shown in millimeters (inches)

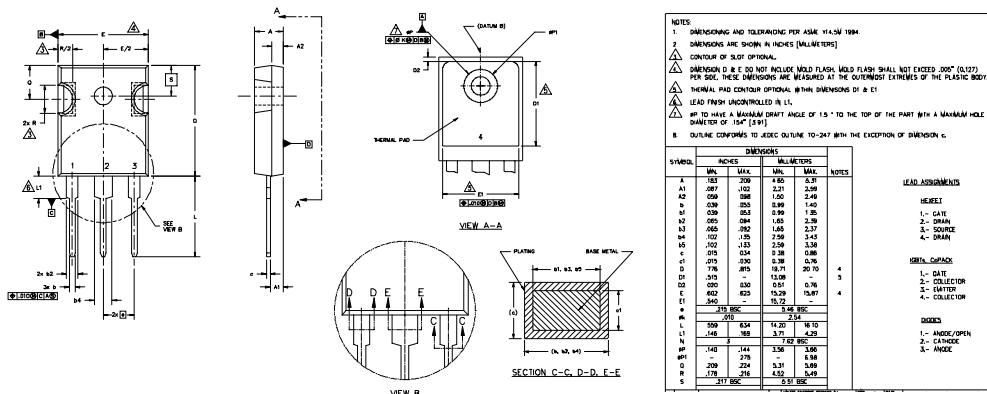

TO-247AC Part Marking Information

EXAMPLE: THIS IS AN IRFPE30
WITH ASSEMBLY
LOT CODE 5657
ASSEMBLED ON WW 35, 2000
IN THE ASSEMBLY LINE "H"

Note: "P" in assembly line
position indicates "Lead-Free"

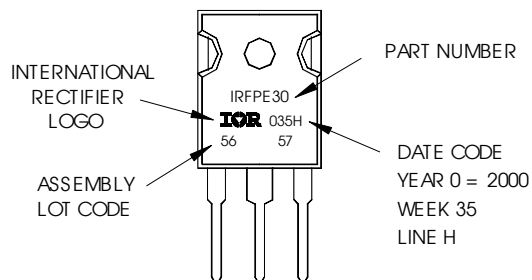

Data and specifications subject to change without notice.