

NEW

PHOTODIODE

InGaAs PIN photodiode array

G8909-01

Photodiode array for DWDM monitor

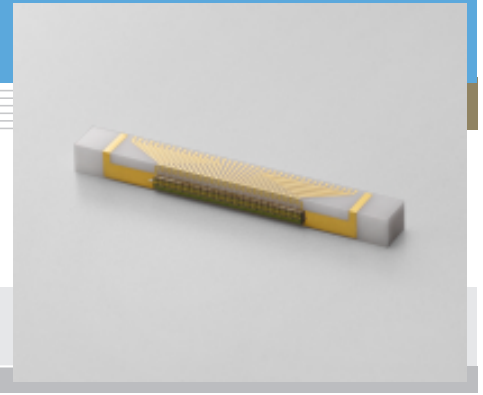
**Features**

- 250 μm pitch, 40 ch parallel readout
- Low cross-talk
- Precise chip position tolerance: ± 0.05 mm

Applications

- DWDM monitor with AWG

General ratings

Parameter	Value	Unit
Active area	$\phi 0.08$	mm
Pixel pitch	250	μm
Number of elements	40	ch

Absolute maximum ratings

Parameter	Symbol	Remark	Value	Unit
Reverse voltage	V_R Max.		6	V
Allowable input power	P_{in} Max.		10	mW
Operating temperature	T_{opr}	*	-40 to +85	$^{\circ}\text{C}$
Storage temperature	T_{stg}		-40 to +85	$^{\circ}\text{C}$

* In N_2 environment or in vacuum**Electrical and optical characteristics ($T_a=25^{\circ}\text{C}$, per 1 element)**

Parameter	Symbol	Condition	Min.	Typ.	Max.	Unit
Spectral response range	λ		-	0.9 to 1.7	-	μm
Photo sensitivity	S	$\lambda=1.31 \mu\text{m}$	0.8	0.9	-	A/W
		$\lambda=1.55 \mu\text{m}$	0.85	0.95	-	
Photo response non-uniformity	PRNU		-	-	± 5	%
Dark current	I_D	$V_R=5$ V	-	0.02	0.2	nA
Shunt resistance	Rsh	$V_R=10$ mV	-	8	-	$\text{G}\Omega$
Terminal capacitance	C_t	$V_R=5$ V, $f=1$ MHz	-	1.4	-	pF
Cross-talk	-	$V_R=0.1$ V	-	-33	-	dB

■ Spectral response

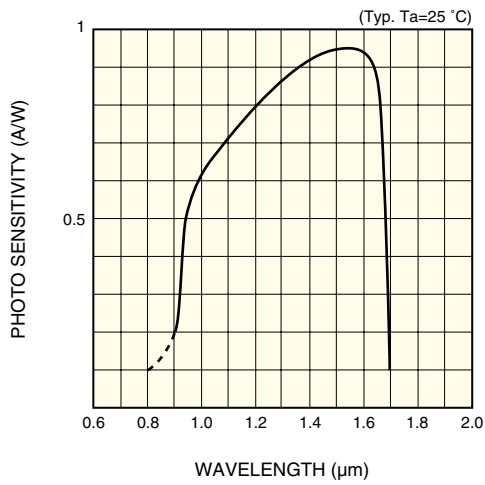

KIRDB0002EB

■ Dark current vs. reverse voltage

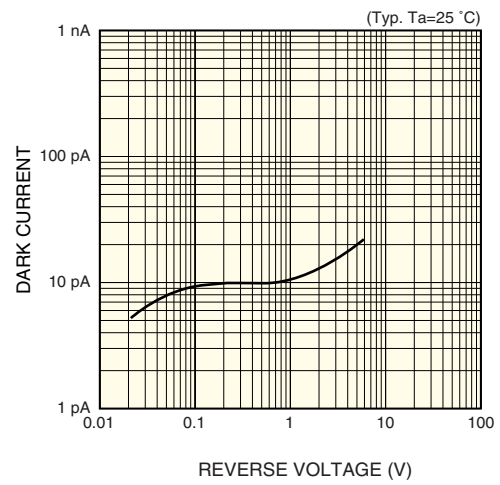

KIRDB0266EA

■ Terminal capacitance vs. reverse voltage

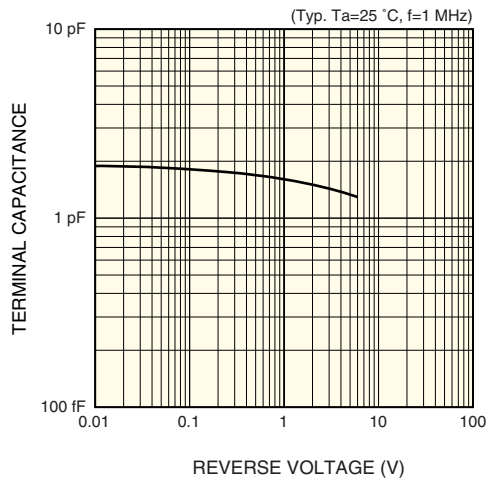

KIRDB0267EA

■ Dark current vs. temperature

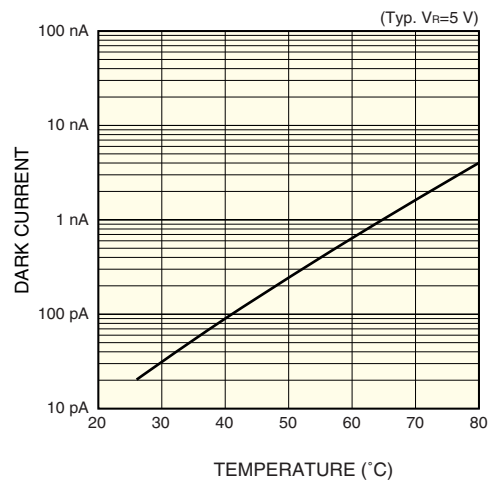

KIRDB0268EA

■ Cross-talk characteristic

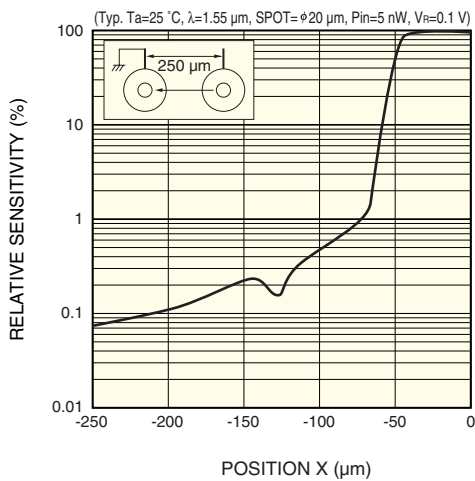

KIRDB0269EA

■ Dimensional outline (unit: mm)

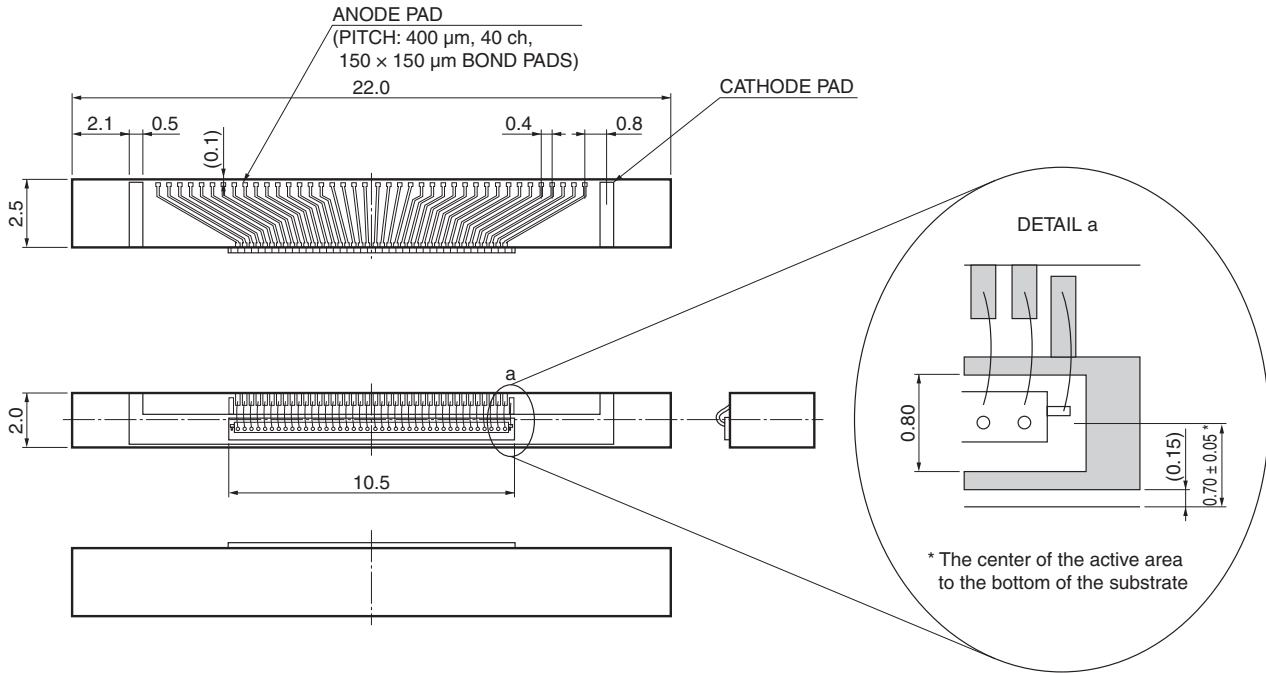

KIRDA0158EA

HAMAMATSU

Information furnished by HAMAMATSU is believed to be reliable. However, no responsibility is assumed for possible inaccuracies or omissions. Specifications are subject to change without notice. No patent rights are granted to any of the circuits described herein. ©2003 Hamamatsu Photonics K.K.

HAMAMATSU PHOTONICS K.K., Solid State Division

1126-1 Ichino-cho, Hamamatsu City, 435-8558 Japan, Telephone: (81) 053-434-3311, Fax: (81) 053-434-5184, <http://www.hamamatsu.com>

U.S.A.: Hamamatsu Corporation: 360 Foothill Road, P.O.Box 6910, Bridgewater, N.J. 08807-0910, U.S.A., Telephone: (1) 908-231-0960, Fax: (1) 908-231-1218

Germany: Hamamatsu Photonics Deutschland GmbH: Arzbergerstr. 10, D-82211 Herrsching am Ammersee, Germany, Telephone: (49) 08152-3750, Fax: (49) 08152-2658

France: Hamamatsu Photonics France S.A.R.L.: 8, Rue du Saule Trapu, Parc du Moulin de Massy, 91882 Massy Cedex, France, Telephone: 33-(1) 69 53 71 00, Fax: 33-(1) 69 53 71 10

United Kingdom: Hamamatsu Photonics UK Limited: 2 Howard Court, 10 Tewin Road, Welwyn Garden City, Hertfordshire AL7 1BW, United Kingdom, Telephone: (44) 1707-294888, Fax: (44) 1707-325777

North Europe: Hamamatsu Photonics Norden AB: Smidesvägen 12, SE-171 41 Solna, Sweden, Telephone: (46) 8-509-031-00, Fax: (46) 8-509-031-01

Italy: Hamamatsu Photonics Italia S.R.L.: Strada della Moia, 1/E, 20020 Arese, (Milano), Italy, Telephone: (39) 02-935-81-733, Fax: (39) 02-935-81-741