

MURD330

SWITCHMODE Power Rectifier

DPAK Surface Mount Package

These state-of-the-art devices are designed for use in switching power supplies, inverters and as free wheeling diodes.

Features

- Low Forward Voltage Drop
- Low Leakage
- Ultra-Fast Recovery Time
- Pb-Free Package is Available

Mechanical Characteristics

- Case: Epoxy, Molded
- Weight: 0.4 Gram (Approximately)
- Finish: All External Surfaces Corrosion Resistant and Terminal Leads are Readily Solderable
- Lead and Mounting Surface Temperature for Soldering Purposes: 260°C Max. for 10 Seconds

MAXIMUM RATINGS

Rating	Symbol	Value	Unit
Rated Reverse Voltage	V_R	300	V
Average Rectified Forward Current	I_F	3	A
Non-Repetitive Peak Surge Current	I_{FSM}	75	A
Operating Junction and Storage Temperature Range	T_J, T_{stg}	-55 to +175	°C

Maximum ratings are those values beyond which device damage can occur. Maximum ratings applied to the device are individual stress limit values (not normal operating conditions) and are not valid simultaneously. If these limits are exceeded, device functional operation is not implied, damage may occur and reliability may be affected.



ON Semiconductor®

<http://onsemi.com>

ULTRAFAST RECTIFIER 3 A, 300 V

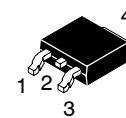
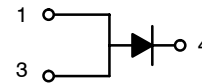

DPAK
CASE 369C

MARKING DIAGRAM

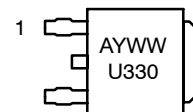

U330 = Specific Device Code
A = Assembly Location
Y = Year
WW = Work Week

ORDERING INFORMATION

Device	Package	Shipping†
MURD330T4	DPAK	2500/Tape & Reel
MURD330T4G	DPAK (Pb-Free)	2500/Tape & Reel

†For information on tape and reel specifications, including part orientation and tape sizes, please refer to our Tape and Reel Packaging Specifications Brochure, BRD8011/D.

www.DataSheet4U.com

MURD330

THERMAL CHARACTERISTICS

Rating	Symbol	Value	Unit
Thermal Resistance – Junction-to-Case	$R_{\theta JC}$	2	$^{\circ}C/W$
Thermal Resistance – Junction-to-Ambient (Note 1)	$R_{\theta JA}$	49	$^{\circ}C/W$

ELECTRICAL CHARACTERISTICS

Rating	Symbol	Value	Unit
Maximum Instantaneous Forward Voltage Drop ($I_F = 3\text{ A}$, $T_J = 25^{\circ}C$) ($I_F = 3\text{ A}$, $T_J = 150^{\circ}C$)	V_F	1.15 0.92	V
Maximum Instantaneous Reverse Current ($T_J = 25^{\circ}C$, 300 V) ($T_J = 150^{\circ}C$, 300 V)	I_R	5 500	μA
Maximum Reverse Recovery Time ($I_F = 1\text{ Amp}$, $di/dt = 50\text{ A}/\mu s$, $V_R = 30\text{ V}$, $T_J = 25^{\circ}C$)	t_{rr}	50	ns
ESD Ratings:	Machine Model = C Human Body Model = 3B	> 400 > 8000	V

1. Rating applies when surface mounted on a 700 mm², 1 oz Cu heat spreader.

TYPICAL CHARACTERISTICS

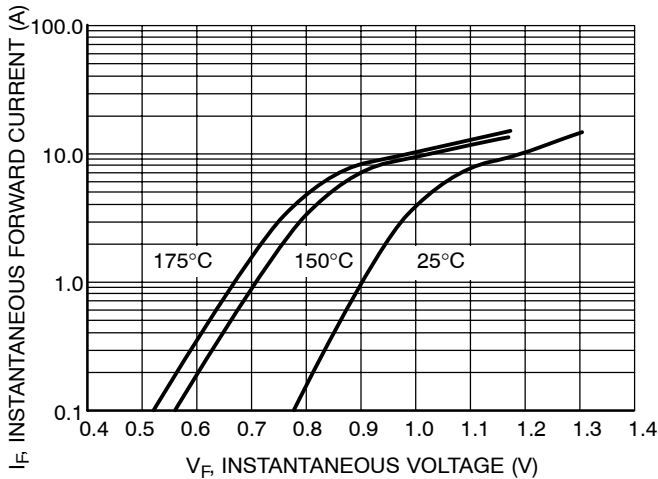

Figure 1. Typical Forward Voltage

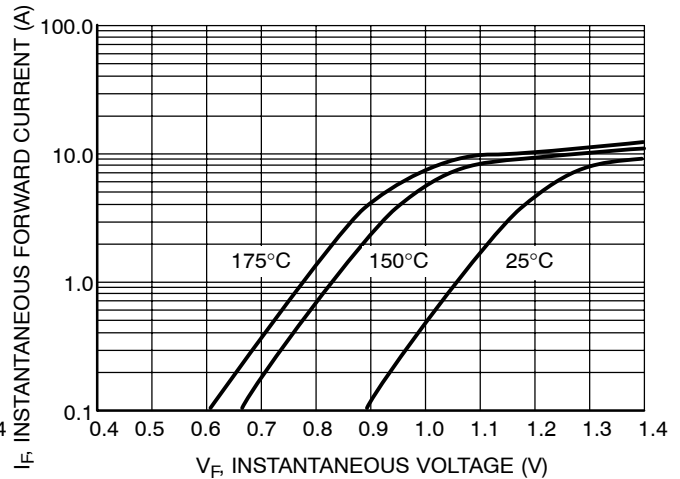

Figure 2. Maximum Forward Voltage

MURD330

TYPICAL CHARACTERISTICS

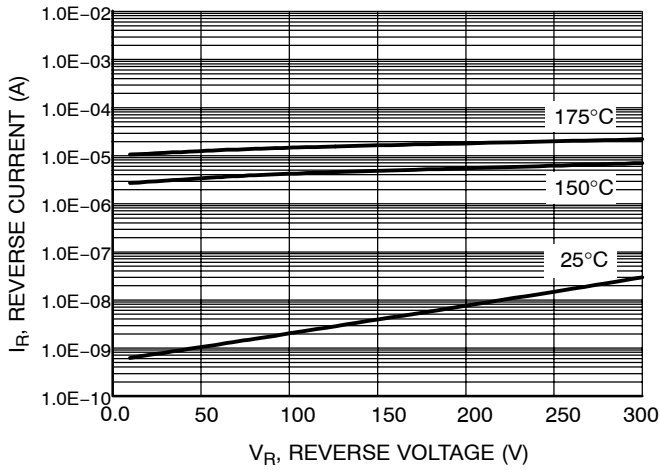

Figure 3. Typical Reverse Voltage

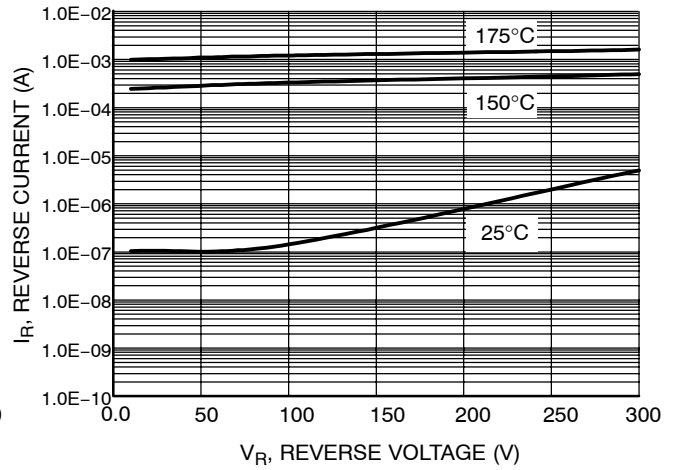

Figure 4. Maximum Reverse Voltage

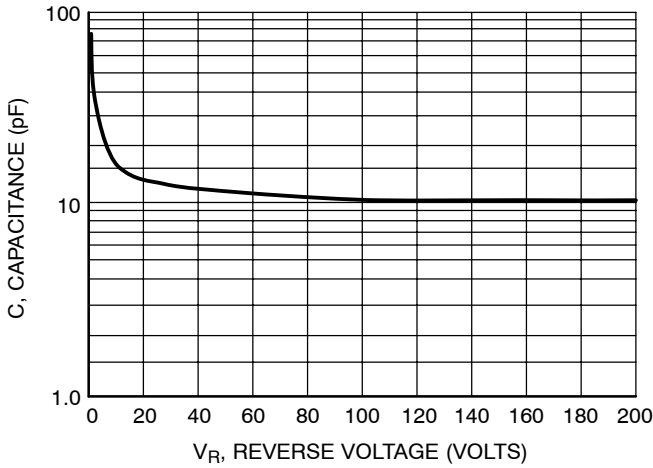

Figure 5. Typical Capacitance

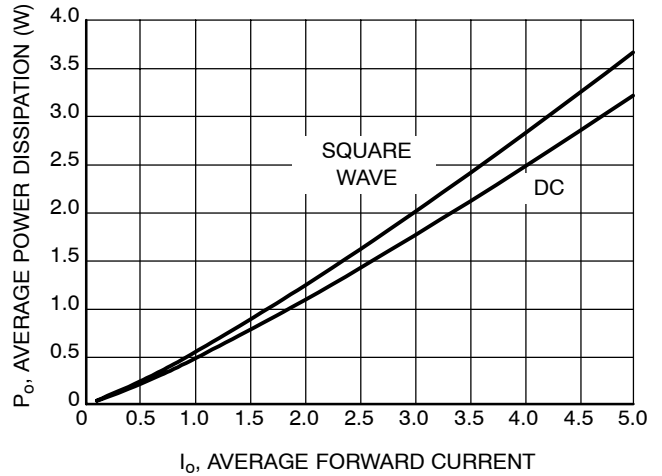

Figure 6. Power Dissipation

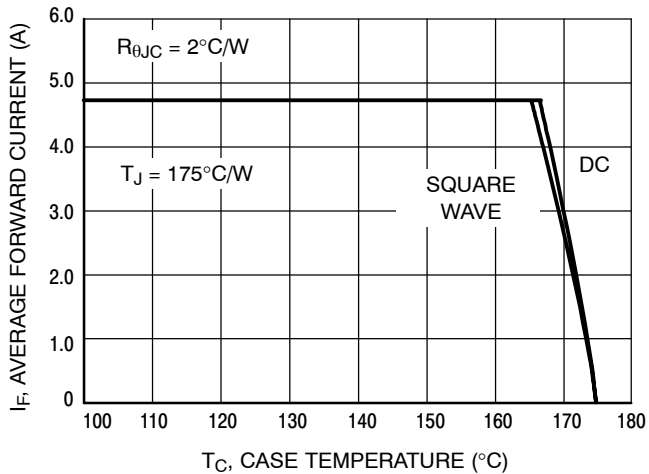

Figure 7. Current Derating, Case

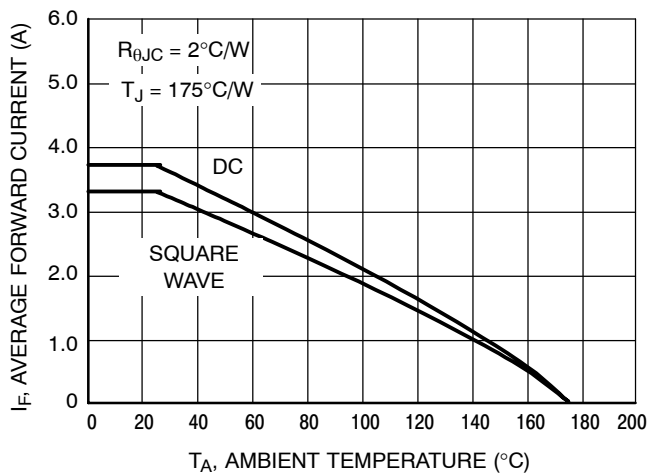
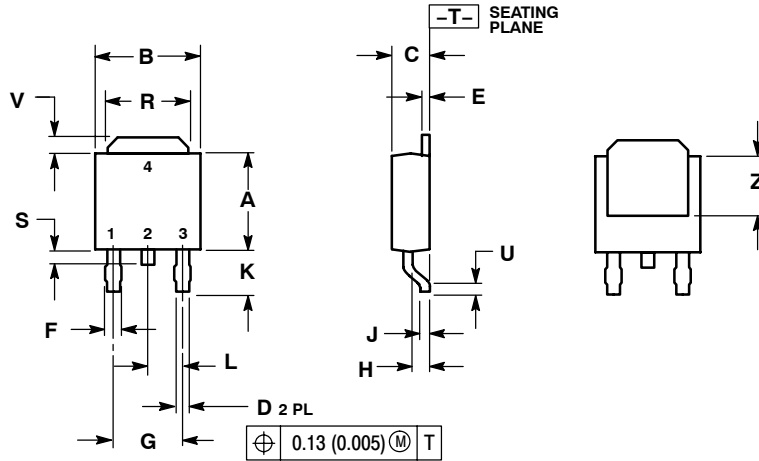

Figure 8. Current Derating, Ambient

MURD330

PACKAGE DIMENSIONS

DPAK
CASE 369C-01
ISSUE O



- NOTES:
1. DIMENSIONING AND TOLERANCING PER ANSI Y14.5M, 1982.
2. CONTROLLING DIMENSION: INCH.

DIM	INCHES		MILLIMETERS	
	MIN	MAX	MIN	MAX
A	0.235	0.245	5.97	6.22
B	0.250	0.265	6.35	6.73
C	0.086	0.094	2.19	2.38
D	0.027	0.035	0.69	0.88
E	0.018	0.023	0.46	0.58
F	0.037	0.045	0.94	1.14
G	0.180 BSC		4.58 BSC	
H	0.034	0.040	0.87	1.01
J	0.018	0.023	0.46	0.58
K	0.102	0.114	2.60	2.89
L	0.090 BSC		2.29 BSC	
R	0.180	0.215	4.57	5.45
S	0.025	0.040	0.63	1.01
U	0.020	---	0.51	---
V	0.035	0.050	0.89	1.27
Z	0.155	---	3.93	---

SOLDERING FOOTPRINT*

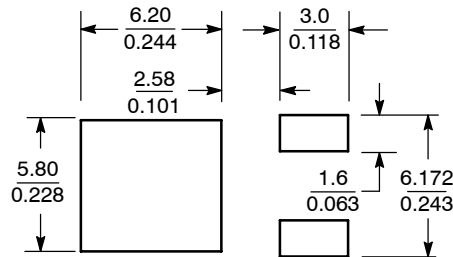

SCALE 3:1 $\left(\frac{\text{mm}}{\text{inches}}\right)$

*For additional information on our Pb-Free strategy and soldering details, please download the ON Semiconductor Soldering and Mounting Techniques Reference Manual, SOLDERRM/D.

SWITCHMODE is a trademark of Semiconductor Components Industries, LLC (SCILLC).

ON Semiconductor and are registered trademarks of Semiconductor Components Industries, LLC (SCILLC). SCILLC reserves the right to make changes without further notice to any products herein. SCILLC makes no warranty, representation or guarantee regarding the suitability of its products for any particular purpose, nor does SCILLC assume any liability arising out of the application or use of any product or circuit, and specifically disclaims any and all liability, including without limitation special, consequential or incidental damages. "Typical" parameters which may be provided in SCILLC data sheets and/or specifications can and do vary in different applications and actual performance may vary over time. All operating parameters, including "Typicals" must be validated for each customer application by customer's technical experts. SCILLC does not convey any license under its patent rights nor the rights of others. SCILLC products are not designed, intended, or authorized for use as components in systems intended for surgical implant into the body, or other applications intended to support or sustain life, or for any other application in which the failure of the SCILLC product could create a situation where personal injury or death may occur. Should Buyer purchase or use SCILLC products for any such unintended or unauthorized application, Buyer shall indemnify and hold SCILLC and its officers, employees, subsidiaries, affiliates, and distributors harmless against all claims, costs, damages, and expenses, and reasonable attorney fees arising out of, directly or indirectly, any claim of personal injury or death associated with such unintended or unauthorized use, even if such claim alleges that SCILLC was negligent regarding the design or manufacture of the part. SCILLC is an Equal Opportunity/Affirmative Action Employer. This literature is subject to all applicable copyright laws and is not for resale in any manner.

PUBLICATION ORDERING INFORMATION

LITERATURE FULFILLMENT:
Literature Distribution Center for ON Semiconductor
P.O. Box 61312, Phoenix, Arizona 85082-1312 USA
Phone: 480-829-7710 or 800-344-3860 Toll Free USA/Canada
Fax: 480-829-7709 or 800-344-3867 Toll Free USA/Canada
Email: orderlit@onsemi.com

N. American Technical Support: 800-282-9855 Toll Free
USA/Canada

Japan: ON Semiconductor, Japan Customer Focus Center
2-9-1 Kamimeguro, Meguro-ku, Tokyo, Japan 153-0051
Phone: 81-3-5773-3850

ON Semiconductor Website: <http://onsemi.com>

Order Literature: <http://www.onsemi.com/litorder>

For additional information, please contact your local Sales Representative.