

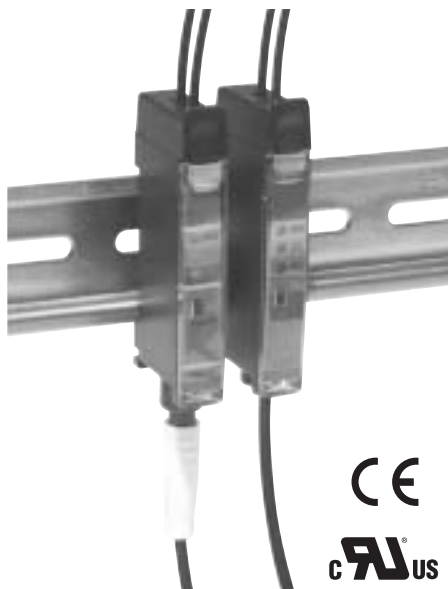

## D11 Expert Series, Visible Green, Blue or White LED Light Source

Low-cost TEACH-mode sensors for use with plastic fiber optics



### Features

- Visible green, blue or white LED light source for use in color mark sensing and other low-contrast sensing applications
- Low-cost, 10 to 30V dc self-contained TEACH mode sensors for use with all Banner plastic fiber optics
- Compact 11 mm-wide housing designed for DIN rail mounting; can also be mounted to any surface using the supplied mounting bracket
- Easy push-button TEACH mode programming automatically adjusts sensitivity to optimal setting
- Designed for high performance, even in low-contrast sensing applications
- Fast, 200 microsecond (0.2 millisecond) output response; a 40 millisecond output pulse stretcher may be programmed, when needed
- Choose models with NPN (sinking) or PNP (sourcing) output
- Output may be programmed for either light or dark operate
- Separate input for remote programming by external switch, process controller, etc.
- LED status indicators for power ON, output state, received signal strength, and sensing contrast
- Choose models with integral 2 m (6.5') cable or Pico-style quick-disconnect (QD) connector; 9 m (30') cables are also available

† U.S. Patent #5087838

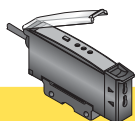

See Sensing Beam Information Below

### D11 Expert Series Models

Models	Cable*	Supply Voltage	Output Type	Maximum Range Specifications
				Diffuse mode performance based on 90% reflectance white test card
<b>Visible Green 525 nm</b>				Range varies by sensing mode and fiber optics used:  PIT46U fibers, opposed mode: 50 mm (2.0") <sup>†</sup> PIT66U fibers, opposed mode: 80 mm (3.1")  PBT46U fiber, diffuse mode: 17 mm (0.7") PBT66U fiber, diffuse mode: 25 mm (1.0")  <sup>†</sup> Opposed mode range may be extended using optional lenses (see Banner Products Catalog for available lenses).
<b>D11EN6FPG</b> <b>D11EN6FPGQ</b>	2 m (6.5') 4-pin Pico QD	10-30V dc	NPN (sinking)	
<b>D11EP6FPG</b> <b>D11EP6FPGQ</b>	2 m (6.5') 4-pin Pico QD		PNP (sourcing)	
<b>Visible Blue 470 nm</b>				
<b>D11EN6FPB</b> <b>D11EN6FPBQ</b>	2 m (6.5') 4-pin Pico QD	10-30V dc	NPN (sinking)	
<b>D11EP6FPB</b> <b>D11EP6FPBQ</b>	2 m (6.5') 4-pin Pico QD		PNP (sourcing)	
<b>Visible White 450 - 650 nm</b>				
<b>D11EN6FPW</b> <b>D11EN6FPWQ</b>	2 m (6.5') 4-pin Pico QD	10-30V dc	NPN (sinking)	
<b>D11EP6FPW</b> <b>D11EP6FPWQ</b>	2 m (6.5') 4-pin Pico QD		PNP (sourcing)	

\*NOTE: 9 m (30') cables are available by adding suffix "W/30" to the model number of any cabled sensor (e.g., **D11EN6FPG W/30**). A model with a QD connector requires an optional mating cable (see page 6).

# D11E Series Sensors – Visible Green, Blue or White LED Light Source

## RUN Mode

Normal operation of the D11 Expert is called RUN mode. The LED indicators operate in RUN mode, as follows:

Indicator	LED Color	Function
Power "ON"	Green	1) On steadily whenever power is applied 2) Flashes at approximately 4Hz to indicate that the output is overloaded
Output Indicator	Yellow	Follows the action of the output: On when the output is energized Off when the output is de-energized
Signal Strength	Red	Lights whenever the sensor "sees" its modulated light source and pulses at a rate which is proportional to the received light signal strength

The Signal Strength indicator is Banner's exclusive AID™ (Alignment Indicating Device, U.S. Patent #4356393). This feature makes alignment during the TEACH mode easy and accurate and provides a means of signaling when maintenance is needed when the sensor is in RUN mode. Whenever the pulse rate is slow, the fiber sensing ends should be cleaned and/or the alignment checked.

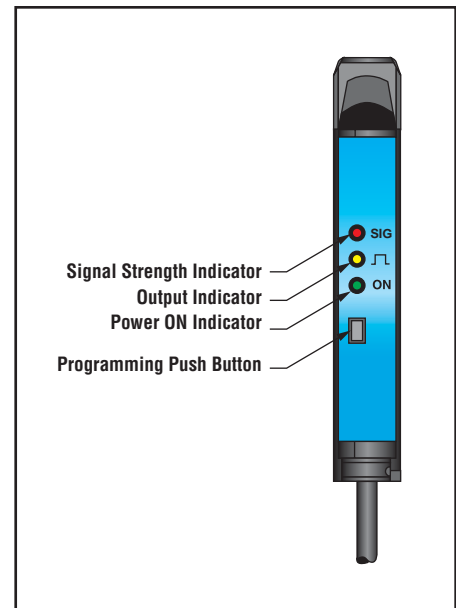

Figure 1. D11E Expert Features

## TEACH Mode

Sensitivity is automatically set (and optimized) by "teaching" the sensor the light and dark conditions. This is accomplished in TEACH mode. TEACH mode simply requires that each of the two sensing conditions be presented to the fiber optics. When the push button is clicked, the sensor samples the sensing condition and registers it into memory. After the second sensing condition is registered, the D11E automatically sets the sensitivity to the optimum value for the application, and then returns to RUN mode.

*NOTE: There is a period of a few seconds at the end of TEACH mode before RUN mode begins.*

## Light or Dark Operate Selection

The two sensing conditions may be presented in either order: the light condition first, and then the dark condition, or vice versa. The condition presented first is the condition for which the output will energize. In other words, the output will be light operated if the light condition is TEACH condition #1, or the output will be dark operated if the dark condition is TEACH condition #1.

# D11E Series Sensors – Visible Green, Blue or White LED Light Source

Number of Flashes at end of TEACH mode	Relative Contrast
1	Unacceptable
2	Low
3	Moderate
4	High

## Contrast Indication

When the push button is clicked to teach the second sensing condition, the three LED indicators flash simultaneously to indicate relative sensing contrast. Contrast is the difference in light level between the two sensing conditions. Higher contrast allows higher sensitivity level, and resulting higher excess gain. A high contrast level is directly related to sensing reliability, and forgiveness to subtle changes in sensing conditions. The display of contrast at the end of the TEACH mode is as follows:

NOTE: If the relative contrast level is unacceptable (1 flash), the program will return to TEACH Condition #1.

## TEACH Mode Programming

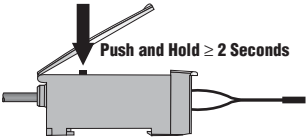
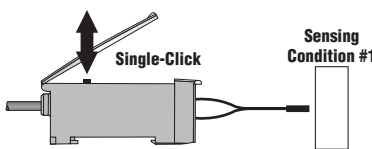
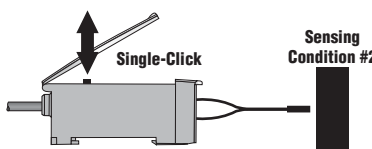
Push Button		Resulting Indicator Status
Push and hold for $\geq 2$ seconds		<b>Green:</b> Flashes at 1Hz <b>Yellow:</b> OFF <b>Red:</b> Pulses to indicate relative received signal strength
<b>TEACH Condition #1 (Output ON State)</b> Present the first sensing condition to the sensor and single click †  <i>This will be the condition corresponding to the sensor output ON state</i>		<b>Green:</b> Flashes at 2Hz <b>Yellow:</b> OFF <b>Red:</b> Pulses to indicate relative received signal strength
<b>TEACH Condition #2 (Output OFF State)</b> Present the second sensing condition to the sensor and single click  <i>This will be the condition corresponding to the sensor output OFF state</i>		<b>Green, Yellow, and Red</b> indicators flash simultaneously one to four times to indicate relative sensing contrast (see chart, above).  After a few seconds, the sensor returns to RUN mode

†NOTE: The sensor will return to RUN mode if the first TEACH condition is not registered within 20 seconds. TEACH mode may be cancelled before either condition #1 or #2 by holding the push button depressed for 2 seconds.

## Maximum Sensitivity Setting

D11E sensors are factory-programmed for maximum sensitivity. This default setting may be easily recalled by holding the push button for two or more seconds to enter TEACH mode, and then clicking the push button four times in a row.

NOTE: The default program includes light operate output and pulse stretcher OFF.

# D11E Series Sensors – Visible Green, Blue or White LED Light Source

## Output Pulse Stretcher

A 40 millisecond pulse stretcher (OFF-delay) may be enabled for applications where a very short sensing event might be missed due to the response of the load or input connected to the sensor output. The pulse stretcher is turned ON or OFF using the following procedure:

### Output Pulse Stretcher Programming

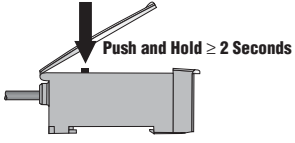
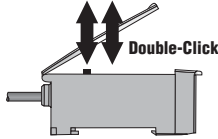
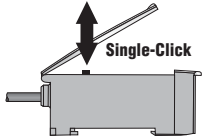
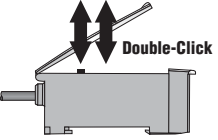
Push Button		Resulting Indicator Status	
Push and hold for $\geq 2$ seconds		<b>Green:</b> Flashes at 1Hz <b>Yellow:</b> OFF <b>Red:</b> Pulses to indicate relative received signal strength	
<b>Pulse Stretcher</b> Double-click to display status  Single-click to toggle pulse stretcher ON or OFF	 	pulse stretcher ON: <b>Green:</b> OFF <b>Yellow:</b> OFF <b>Red:</b> ON steadily	pulse stretcher OFF: <b>Green:</b> OFF <b>Yellow:</b> OFF <b>Red:</b> Double-Flash
Double-click to save configuration and return to <b>RUN</b> mode		See page 2	

# D11E Series Sensors – Visible Green, Blue or White LED Light Source

## D11E Expert Series Specifications

<b>Required Fiber Optic Cable</b>	PI or PB Series plastic fibers
<b>Sensing Beam</b>	Visible green, 525 nm; visible blue, 470 nm; visible white, 450-650 nm
<b>Supply Voltage and Current</b>	10 to 30V dc (10% maximum ripple) at less than 45 mA, exclusive of load
<b>Supply Protection Circuitry</b>	Protected against reverse polarity and transient voltages
<b>Output Configuration</b>	One (SPST) NPN (sinking) or PNP (sourcing) open-collector transistor, depending on model; Programmable for light or dark operate
<b>Output Rating</b>	150 mA maximum; <b>OFF-state leakage current:</b> < 5 microamps at 30V dc; <b>ON-state saturation voltage:</b> < 1V at 10 mA dc; < 1.5V at 150 mA dc
<b>Output Protection Circuitry</b>	Protected against false pulse on power-up and continuous overload or short-circuit
<b>Output Response Time</b>	200 microseconds (0.2 milliseconds) ON and OFF (40 milliseconds OFF when pulse stretcher is programmed). NOTE: 100 millisecond delay on power-up; output does not conduct during this time
<b>Output Timing Functions</b>	ON/OFF (no delay) or fixed 40 millisecond OFF-Delay pulse stretcher; selected by push button
<b>Repeatability</b>	65 microseconds
<b>Adjustments</b>	Push-button TEACH-mode sensitivity setting (see TEACH Mode information); remote TEACH-mode input is provided
<b>Indicators</b>	Three LEDs: Green, Yellow and Red <b>Green LED</b> lights for dc power ON and flashes when ready to register sensing condition during TEACH mode: 1 Hz when waiting to learn first sensing condition, 2 Hz when waiting to learn second sensing condition, 4 Hz when output is overloaded  <b>Yellow LED</b> lights for output ON (conducting)  <b>Red LED</b> is Banner's patented Alignment Indicating Device (AID™, U.S. patent #4356393) which lights whenever the sensor "sees" a light condition and superimposes a pulse rate which is proportional to the strength of the received light signal (the stronger the signal, the faster the pulse rate)
<b>Construction</b>	Black ABS (Cyclocac® KJB) flame-retardant housing with acrylic cover; Stainless steel M3 x 0.5 hardware for use with ABS (Cyclocac® KJB) mounting bracket (supplied)
<b>Environmental Rating</b>	IEC IP54; NEMA 2
<b>Connections</b>	2 m (6.5') or 9 m (30') attached cable, or 4-pin Pico-style quick-disconnect fitting; cables for QD models are purchased separately
<b>Operating Conditions</b>	<b>Temperature:</b> -10° to +55°C (-14° to +131°F) <b>Maximum relative humidity:</b> 90% at 50°C (non-condensing)
<b>Certifications</b>	

Cyclocac® is a registered trademark of General Electric Company.



### **WARNING . . . Not To Be Used for Personnel Protection**

**Never use these products as sensing devices for personnel protection. Doing so could lead to serious injury or death.**

These sensors do NOT include the self-checking redundant circuitry necessary to allow their use in personnel safety applications. A sensor failure or malfunction can cause either an energized or de-energized sensor output condition. Consult your current Banner Safety Products catalog for safety products which meet OSHA, ANSI and IEC standards for personnel protection.

# D11E Series Sensors – Visible Green, Blue or White LED Light Source

## D11E Series Hookups

### Sensors with NPN (Sinking) Outputs

#### Cabled Hookup

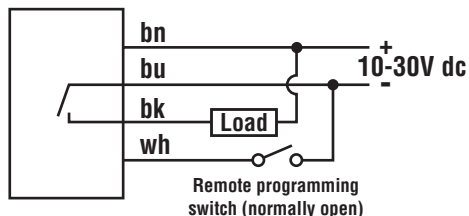

#### Quick-Disconnect Hookup

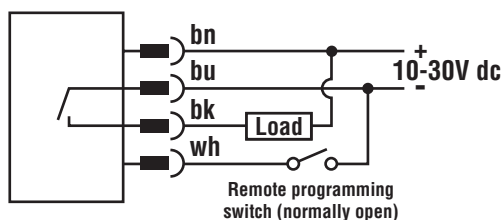

### Sensors with PNP (Sourcing) Outputs

#### Cabled Hookup

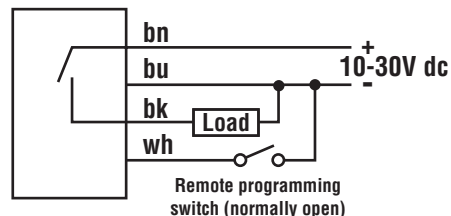

#### Quick-Disconnect Hookup

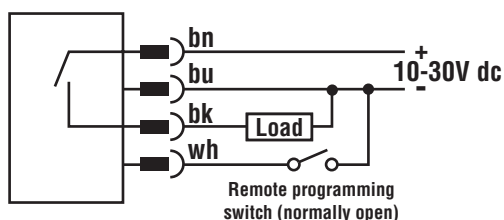

## Quick-Disconnect (QD) Cables

The following cables are available for D11E QD models

Style	Model	Length	For use with	Dimensions	Pinout
4-pin Pico-style straight	PKG4-2	2 m (6.5')	All D11 sensors with quick-disconnect fitting		
4-pin Pico-style right-angle	PKW4-2	2 m (6.5')			

# D11E Series Sensors – Visible Green, Blue or White LED Light Source

## Dimensions

### Cabled models

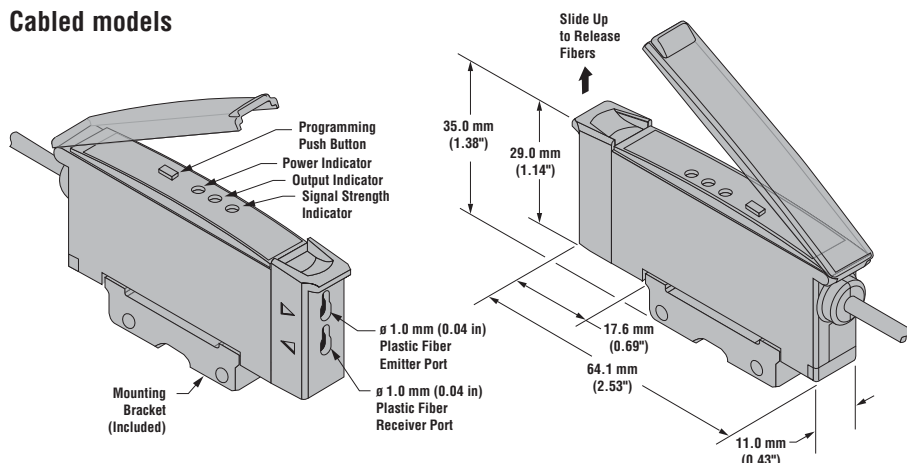

### Quick disconnect models

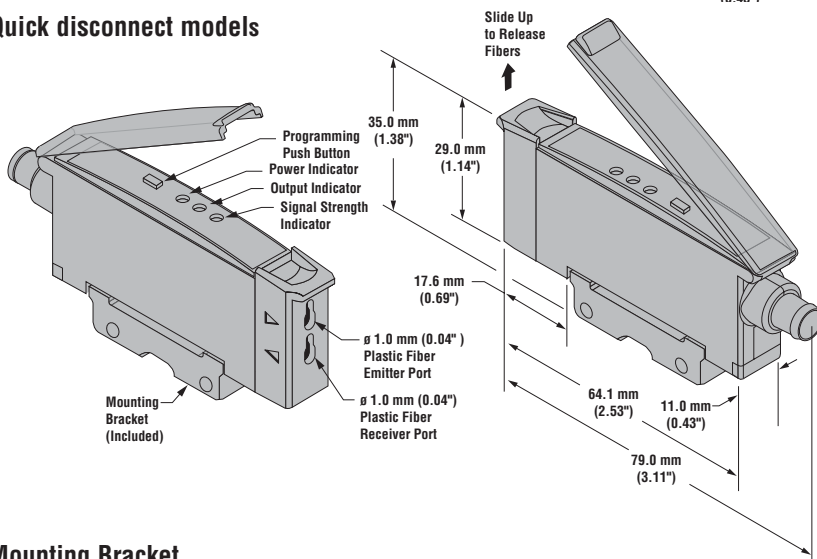

### Mounting Bracket

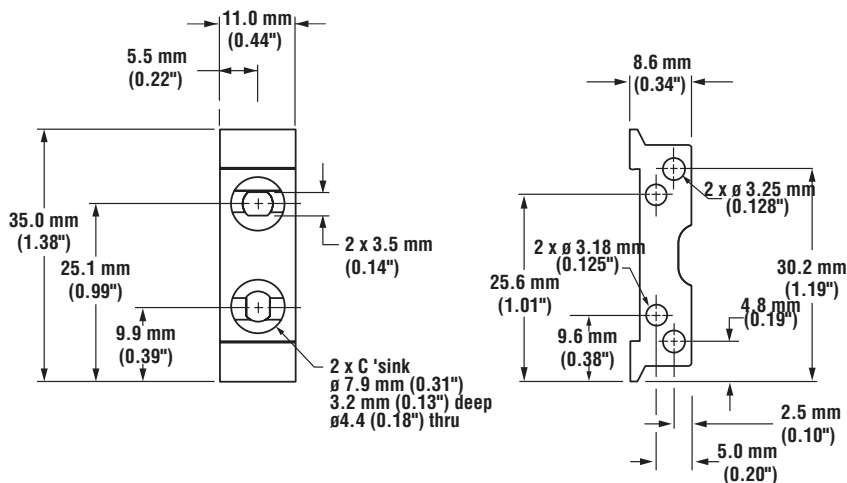

### Plastic Fiber Installation:

1. Cut fiber ends per instructions included with the fibers. Slide the fiber gripper up (open). For 0.25 mm or 0.5 mm diameter fibers, insert the adapter (shown below) into the ports as far as it will go.
2. All fibers: Insert the prepared plastic fiber sensor ends gently into the ports as far as they will go.
3. Slide the fiber gripper back down to lock.

### Fiber Adaptor

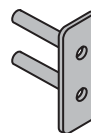

Adaptor (included) is for use with 0.25 mm (0.01") or 0.5 mm (0.02") diameter fibers

### DIN Rail Mounting

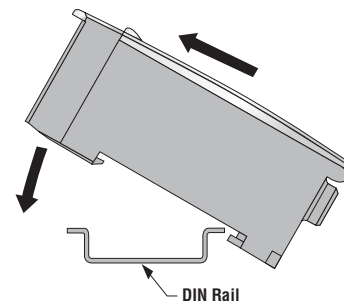

# D11E Series Sensors – Visible Green, Blue or White LED Light Source

## Remote Programming

The white wire of the D11E may be connected to a remote switch for the following sensor programming functions:

- 1) Disable or enable the push button
- 2) TEACH mode programming of sensitivity
- 3) Enable or disable the 40-millisecond pulse stretcher.

A remote programming switch is connected between the white wire and dc common (see hookup diagrams on page 6). The switch may be either a normally-open contact, or an open-collector NPN transistor which has its emitter connected to dc common.

Programming is accomplished using a specified sequence of input pulses. The duration of each pulse ("T") is defined: 0.04 seconds < T < 0.8 seconds.

The required spacing between adjacent pulses in a sequence (e.g. a "double-pulse") also "T". The timing diagrams, (right) illustrate the input requirements.

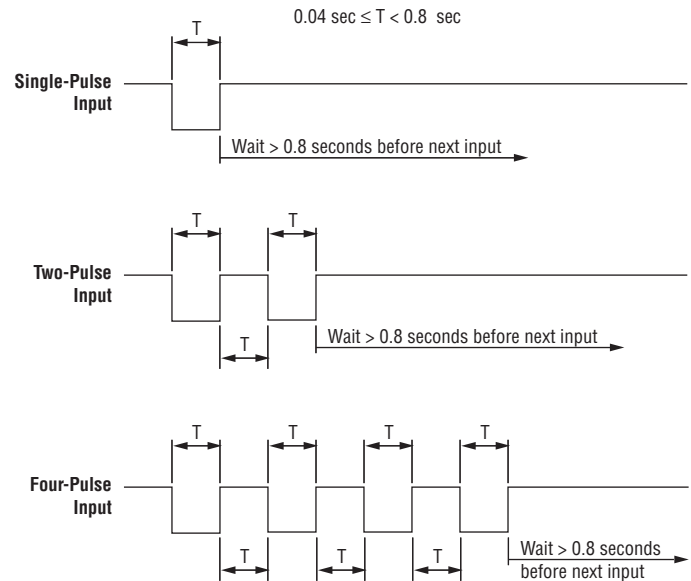

### Disable or Enable the Push Button:

When remote programming is used, exclusively, it may be beneficial to disable the push button on the D11E to increase the security of the settings.

- 1) To disable the push button:  
Pulse the remote input four times (see timing diagram, above).
- 2) To enable the push button at a later date:  
Pulse the input four times (again).

### Set Sensitivity via the TEACH mode:

- 1) Present the first (output ON) sensing condition to the sensor and pulse the remote input once.
- 2) Present the second (output OFF) sensing condition to the sensor and pulse the remote input once. The three LED indicators will flash simultaneously one to four times to indicate relative sensing contrast (see page 3), and the sensor will return to RUN mode.

### Enable or Disable the 40-millisecond Pulse Stretcher:

- 1) Pulse the remote input two times (see timing diagram). The status of the pulse stretcher is indicated by the red LED: The red LED will be lit, steadily, if the pulse stretcher is ON; the red LED will double-flash if the pulse stretcher is OFF.
- 2) Pulse the remote input once to toggle the the pulse stretcher ON or OFF.
- 3) Pulse the remote input two times to save the setting and return to the RUN mode.



**WARRANTY:** Banner Engineering Corp. warrants its products to be free from defects for one year. Banner Engineering Corp. will repair or replace, free of charge, any product of its manufacture found to be defective at the time it is returned to the factory during the warranty period. This warranty does not cover damage or liability for the improper application of Banner products. This warranty is in lieu of any other warranty either expressed or implied.