

20A, 500V N-Channel IGBT with Anti-Parallel Ultrafast Diode

April 1995

Features

- 20A, 500V
- Latch Free Operation
- Typical Fall Time < 500ns
- High Input Impedance
- Low Conduction Loss
- With Anti-Parallel Diode
- $t_{RR} < 60ns$

Description

The IGBT is a MOS gated high voltage switching device combining the best features of MOSFETs and bipolar transistors. The device has the high input impedance of a MOSFET and the low on-state conduction loss of a bipolar transistor. The much lower on-state voltage drop varies only moderately between +25°C and +150°C. The diode used in parallel with the IGBT is an ultrafast ($t_{RR} < 60ns$) with soft recovery characteristic.

IGBTs are ideal for many high voltage switching applications operating at frequencies where low conduction losses are essential, such as: AC and DC motor controls, power supplies and drivers for solenoids, relays and contractors.

PACKAGING AVAILABILITY

PART NUMBER	PACKAGE	BRAND
HGTG20N50C1D	TO-247	G20N50C1D

NOTE: When ordering, use the entire part number.

Package

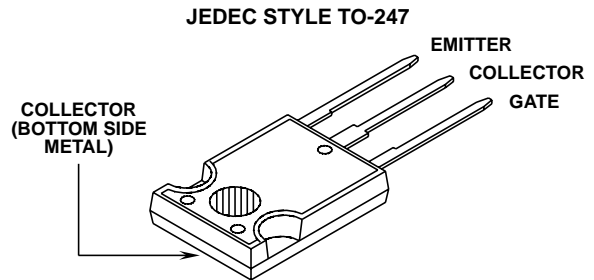

Terminal Diagram

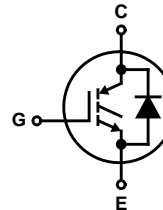

Absolute Maximum Ratings $T_C = +25^\circ C$, Unless Otherwise Specified

	HGTG20N50C1D	UNITS
Collector-Emitter Voltage	500	V
Collector-Gate Voltage $R_{GE} = 1M\Omega$	500	V
Collector Current Continuous at $T_C = +25^\circ C$	26	A
at $T_C = +90^\circ C$	20	A
Collector Current Pulsed (Note 1)	35	A
Gate-Emitter Voltage Continuous	± 20	V
Diode Forward Current at $T_C = +25^\circ C$	26	A
at $T_C = +90^\circ C$	20	A
Power Dissipation Total at $T_C = +25^\circ C$	75	W
Power Dissipation Derating $T_C > +25^\circ C$	0.8	W/°C
Operating and Storage Junction Temperature Range	-55 to +150	°C
Maximum Lead Temperature for Soldering	260	°C

NOTE: 1. $T_J = +150^\circ C$, Minimum $R_{GE} = 25\Omega$ without latch

INTERSIL CORPORATION IGBT PRODUCT IS COVERED BY ONE OR MORE OF THE FOLLOWING U.S. PATENTS:

4,364,073	4,417,385	4,430,792	4,443,931	4,466,176	4,516,143	4,532,534	4,567,641
4,587,713	4,598,461	4,605,948	4,618,872	4,620,211	4,631,564	4,639,754	4,639,762
4,641,162	4,644,637	4,682,195	4,684,413	4,694,313	4,717,679	4,743,952	4,783,690
4,794,432	4,801,986	4,803,533	4,809,045	4,809,047	4,810,665	4,823,176	4,837,606
4,860,080	4,883,767	4,888,627	4,890,143	4,901,127	4,904,609	4,933,740	4,963,951
4,969,027							

Specifications HGTG20N50C1D

Electrical Specifications $T_C = +25^\circ\text{C}$, Unless Otherwise Specified

PARAMETERS	SYMBOL	TEST CONDITIONS	LIMITS		UNITS
			MIN	MAX	
Collector-Emitter Breakdown Voltage	BV_{CES}	$I_C = 1\text{mA}, V_{GE} = 0\text{V}$	500	-	V
Gate Threshold Voltage	$V_{GE(TH)}$	$V_{GE} = V_{CE}, I_C = 1\text{mA}$	2	4.5	V
Zero Gate Voltage Collector Current	I_{CES}	$V_{CE} = 500\text{V}$	-	250	μA
		$T_C = +125^\circ\text{C}, V_{CE} = 500\text{V}$	-	1000	μA
Gate-Emitter Leakage Current	I_{GES}	$V_{GE} = \pm 20\text{V}, V_{CE} = 0\text{V}$	-	100	nA
Collector-Emitter On-Voltage	$V_{CE(SAT)}$	$I_C = 20\text{A}, V_{GE} = 10\text{V}$	-	2.5	V
		$I_C = 35\text{A}, V_{GE} = 20\text{V}$	-	3.2	V
Gate-Emitter Plateau Voltage	V_{GEP}	$I_C = 10\text{A}, V_{CE} = 10\text{V}$	-	6 (Typ)	V
On-State Gate Charge	$Q_{G(ON)}$	$I_C = 10\text{A}, V_{CE} = 10\text{V}$	-	33 (Typ)	nC
Turn-On Delay Time	$t_{D(ON)I}$	$I_C = 20\text{A}, V_{CE(CL P)} = 300\text{V}, L = 25\mu\text{H}, T_J = +100^\circ\text{C}, V_{GE} = 10\text{V}, R_G = 25\Omega$	-	50	ns
Rise Time	t_{RI}		-	50	ns
Turn-Off Delay Time	$t_{D(OFF)I}$		-	400	ns
Fall Time	t_{FI}		400 (Typ)	500	ns
Turn-Off Energy Loss Per Cycle (Off Switching Dissipation = $W_{OFF} \times \text{Frequency}$)	W_{OFF}	$I_C = 20\text{A}, V_{CE(CL P)} = 300\text{V}, L = 25\mu\text{H}, T_J = +100^\circ\text{C}, V_{GE} = 10\text{V}, R_G = 25\Omega$	1070 (Typ)		μJ
Thermal Resistance Junction-to-Case (IGBT)	$R_{\theta JC}$		-	1.25	$^\circ\text{C/W}$
Thermal Resistance of Diode	$R_{\theta JC}$		-	1.5	ns
Diode Forward Voltage	V_{EC}	$I_{EC} = 20\text{A}$	-	1.8	V
Diode Reverse Recovery Time	t_{RR}	$I_{EC} = 20\text{A}, di_{EC}/dt = 100\text{A}/\mu\text{s}$	-	60	ns

Typical Performance Curves

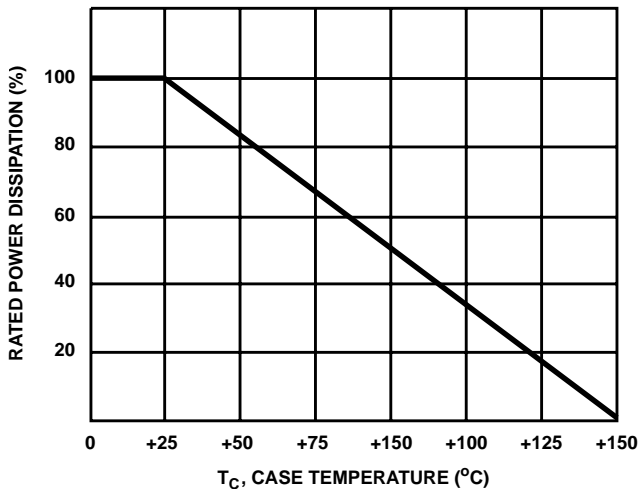

FIGURE 1. POWER DISSIPATION vs TEMPERATURE DERATING CURVE

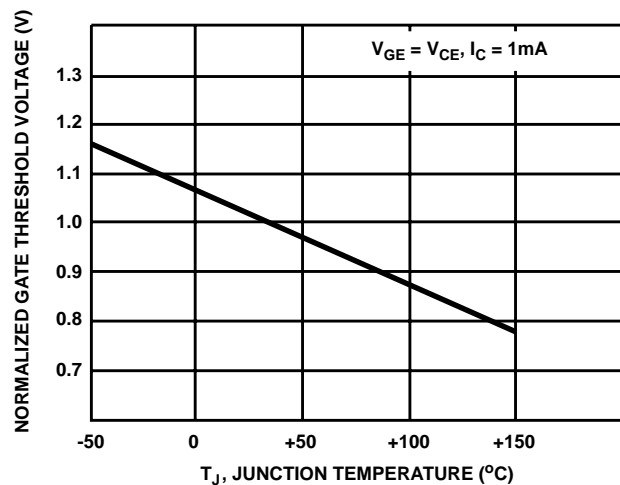

FIGURE 2. TYPICAL NORMALIZED GATE-THRESHOLD VOLTAGE vs JUNCTION TEMPERATURE

Typical Performance Curves (Continued)

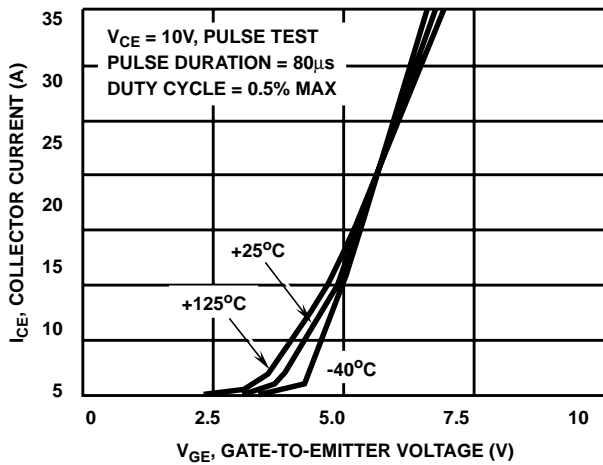

FIGURE 3. TYPICAL TRANSFER CHARACTERISTICS

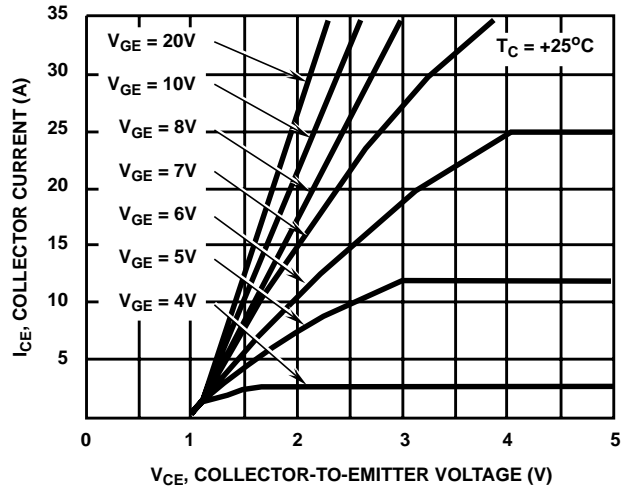

FIGURE 4. TYPICAL SATURATION CHARACTERISTICS

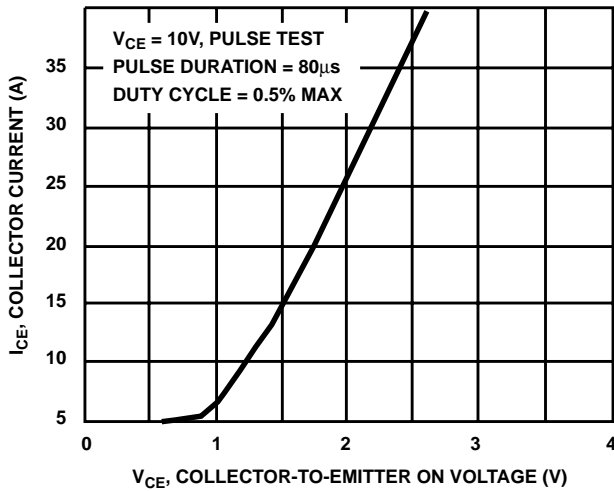

FIGURE 5. TYPICAL COLLECTOR-TO-EMITTER ON-VOLTAGE vs COLLECTOR CURRENT

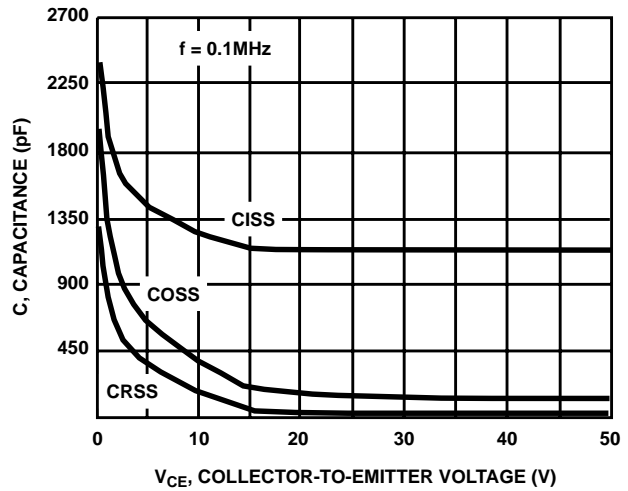

FIGURE 6. CAPACITANCE vs COLLECTOR-TO-EMITTER VOLTAGE

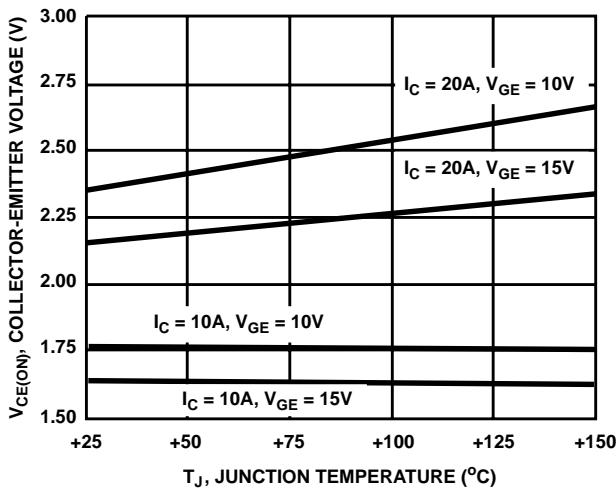

FIGURE 7. TYPICAL $V_{CE(ON)}$ vs TEMPERATURE

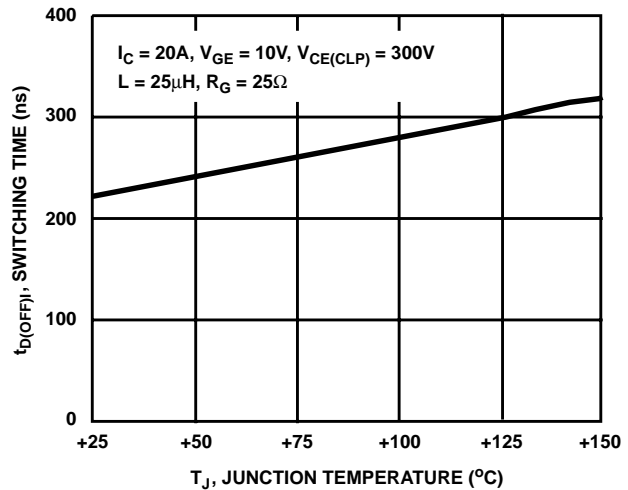

FIGURE 8. TYPICAL TURN-OFF DELAY TIME

Typical Performance Curves (Continued)

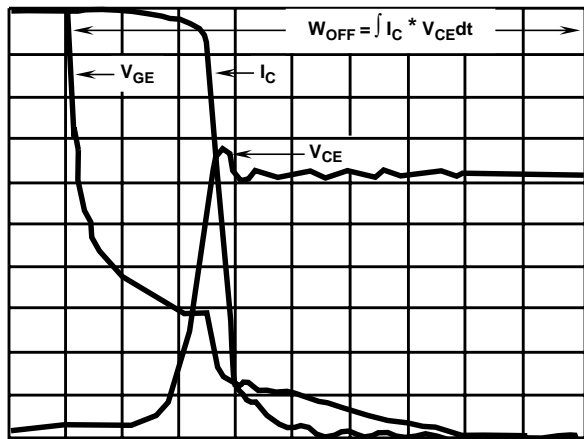

FIGURE 9. TYPICAL INDUCTIVE SWITCHING WAVEFORMS

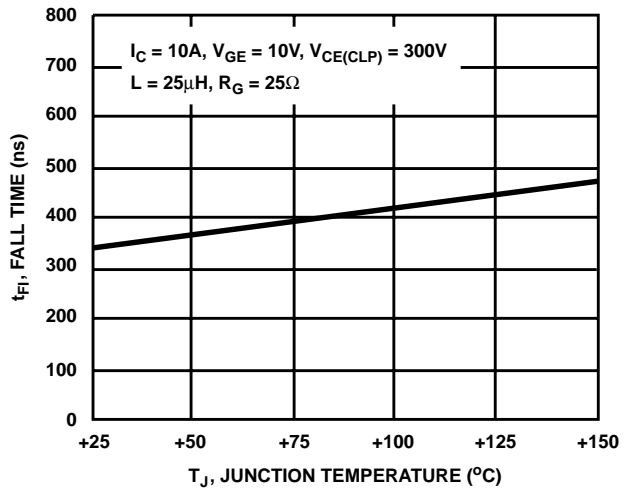

FIGURE 10. TYPICAL FALL TIME ($I_C = 10A$)

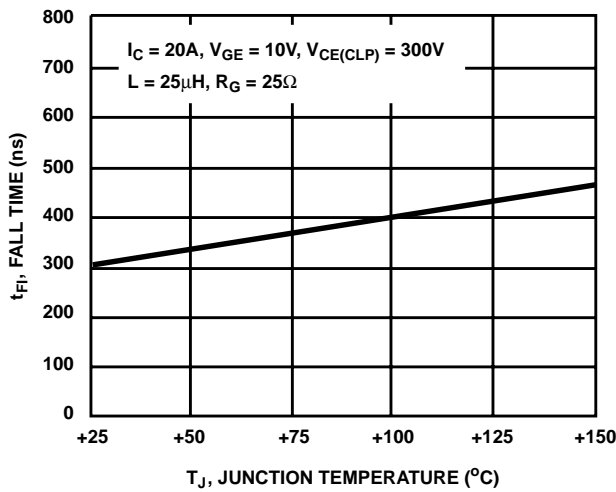

FIGURE 11. TYPICAL FALL TIME ($I_C = 20A$)

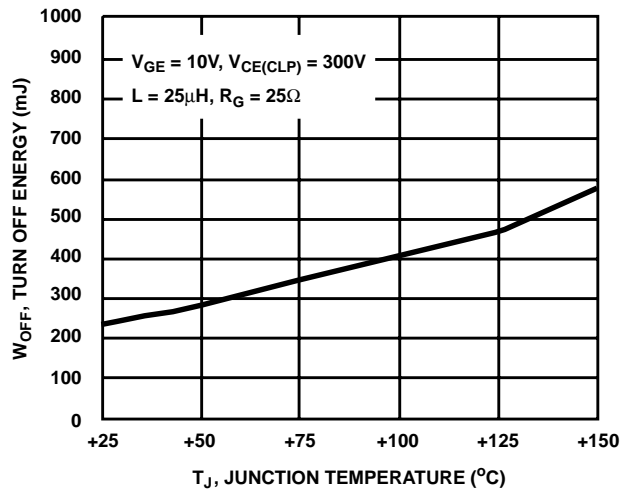
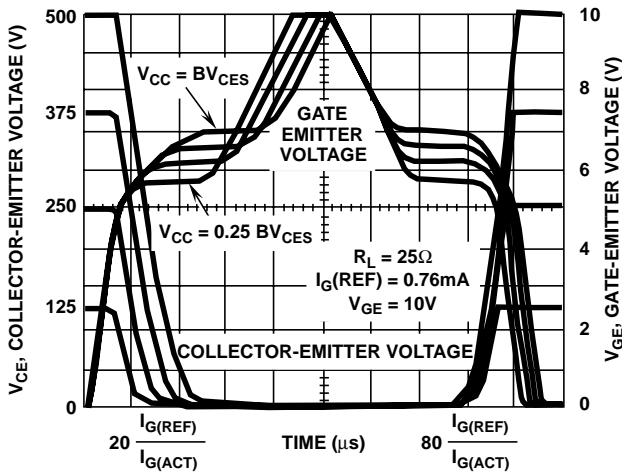

FIGURE 12. TYPICAL CLAMPED INDUCTIVE TURN-OFF SWITCHING LOSS/CYCLE



NOTE: For Turn-Off gate currents in excess of 3mA, V_{CE} Turn-Off is not accurately represented by this normalization.

FIGURE 13. NORMALIZED SWITCHING WAVEFORMS AT CONSTANT GATE CURRENT (REFER TO APPLICATION NOTES AN7254 AND AN7260)

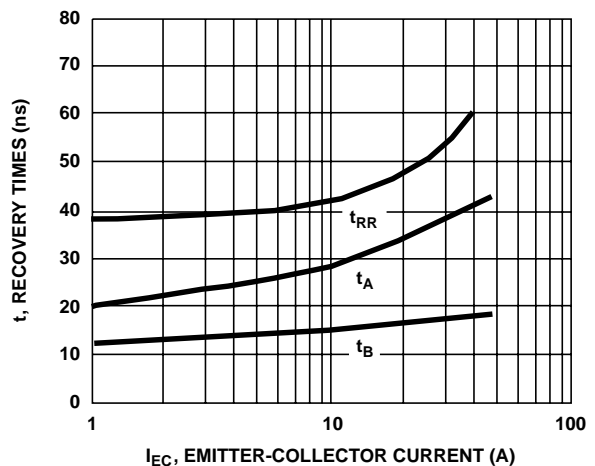

FIGURE 14. TYPICAL t_{RR} , t_A , t_B vs FORWARD CURRENT

HGTG20N50C1D

Typical Performance Curves (Continued)

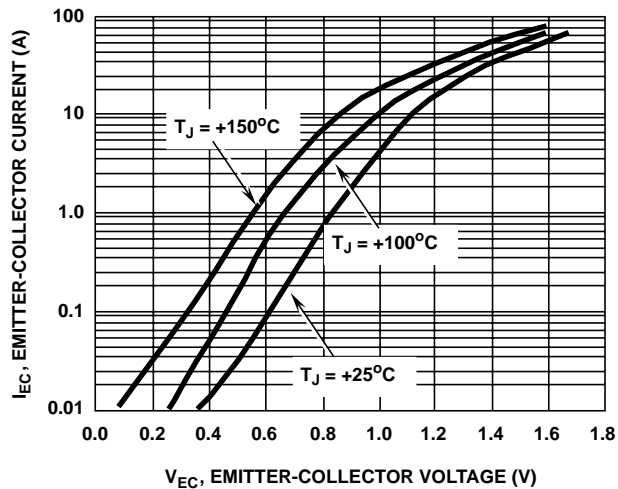

FIGURE 15. FORWARD VOLTAGE vs FORWARD CURRENT CHARACTERISTIC

Test Circuit

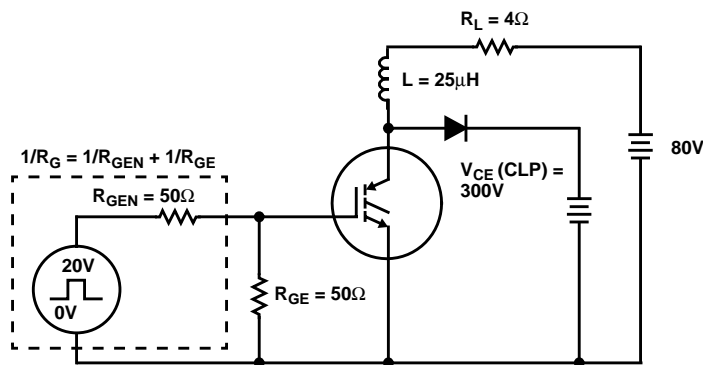

FIGURE 16. INDUCTIVE SWITCHING TEST CIRCUIT

All Intersil semiconductor products are manufactured, assembled and tested under **ISO9000** quality systems certification.

Intersil products are sold by description only. Intersil Corporation reserves the right to make changes in circuit design and/or specifications at any time without notice. Accordingly, the reader is cautioned to verify that data sheets are current before placing orders. Information furnished by Intersil is believed to be accurate and reliable. However, no responsibility is assumed by Intersil or its subsidiaries for its use; nor for any infringements of patents or other rights of third parties which may result from its use. No license is granted by implication or otherwise under any patent or patent rights of Intersil or its subsidiaries.

For information regarding Intersil Corporation and its products, see web site <http://www.intersil.com>

Sales Office Headquarters

NORTH AMERICA
Intersil Corporation
P. O. Box 883, Mail Stop 53-204
Melbourne, FL 32902
TEL: (407) 724-7000
FAX: (407) 724-7240

EUROPE
Intersil SA
Mercure Center
100, Rue de la Fusee
1130 Brussels, Belgium
TEL: (32) 2.724.2111
FAX: (32) 2.724.22.05

ASIA
Intersil (Taiwan) Ltd.
Taiwan Limited
7F-6, No. 101 Fu Hsing North Road
Taipei, Taiwan
Republic of China
TEL: (886) 2 2716 9310
FAX: (886) 2 2715 3029