

General Description

- DCX4710H is best suited for applications where the load needs to be turned on and off using micro-controllers, comparators or other control circuits particularly at a point of load. It features a discrete pre-biased PNP transistor which can support continuous maximum current of 100 mA. It also contains a pre-biased NPN transistor which can be used as a control and can be biased using a higher supply. The component devices can be used as a part of circuit or as stand alone discrete devices.

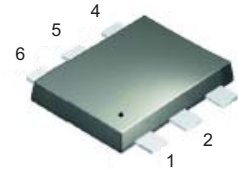

Fig. 1: SOT-563

Features

- Built in Biasing Resistors
- Epitaxial Planar Die Construction
- Ideally Suited for Automated Assembly Processes
- Lead Free By Design/ROHS Compliant (Note 1)**
- "Green" Device (Note 2)**

Mechanical Data

- Case: SOT-563
- Case Material: Molded Plastic. "Green Molding" Compound. UL Flammability Classification Rating 94V-0
- Moisture Sensitivity: Level 1 per J-STD-020C
- Terminal Connections: See Fig. 2
- Terminals: Finish - Matte Tin annealed over Copper leadframe. Solderable per MIL-STD-202, Method 208
- Marking & Type Code Information: See Page 7
- Ordering Information: See Page 7
- Weight: 0.005 grams (approximate)

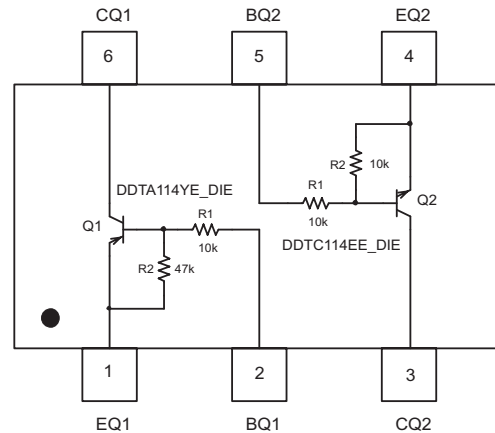

Fig. 2: Schematic and Pin Configuration

Sub-Component P/N	Reference	Device Type	R1 (NOM)	R2 (NOM)	Figure
DDTA114YE_DIE	Q1	PNP	10KΩ	47KΩ	2
DDTC114EE_DIE	Q2	NPN	10KΩ	10KΩ	2

Maximum Ratings: Total Device @ T_A = 25°C unless otherwise specified

Characteristic	Symbol	Value	Unit
Power Dissipation (Note 3)	P _d	150	mW
Power Derating Factor above 45°C	P _{der}	1.43	mW/°C
Output Current	I _{out}	100	mA

Thermal Characteristics @ T_A = 25°C unless otherwise specified

Characteristic	Symbol	Value	Unit
Junction Operation and Storage Temperature Range	T _j , T _{stg}	-55 to +150	°C
Thermal Resistance, Junction to Ambient Air (Note 3) (Equivalent to one heated junction of PNP transistor)	R _{θJA}	833	°C/W

- Notes:
- No purposefully added lead.
 - Diodes Inc.'s "Green" policy can be found on our website at http://www.diodes.com/products/lead_free/index.php.
 - Device mounted on FR-4 PCB, 1 inch x 0.85 inch x 0.062 inch; as per Diodes Inc. suggested pad layout document AP02001 on our website at <http://www.diodes.com/datasheets/ap02001.pdf>.

Sub-Component Device - Pre-Biased PNP Transistor (Q1) @ $T_A = 25^\circ\text{C}$ unless otherwise specified

Characteristic	Symbol	Value	Unit
Collector-Base Voltage	V_{CBO}	-50	V
Collector-Emitter Voltage	V_{CEO}	-50	V
Supply Voltage	V_{CC}	-50	V
Input Voltage	V_{IN}	+6 to -40	V
Output Current (dc)	$I_{C(max)}$	-100	mA

Sub-Component Device - Pre-Biased PNP Transistor (Q1) @ $T_A = 25^\circ\text{C}$ unless otherwise specified

Characteristic	Symbol	Value	Unit
Collector-Base Voltage	V_{CBO}	50	V
Collector-Emitter Voltage	V_{CEO}	50	V
Supply Voltage	V_{CC}	50	V
Input Voltage	V_{IN}	-10 to +40	V
Output Current (dc)	$I_{C(max)}$	100	mA

Electrical Characteristics: Pre-Biased PNP Transistor (Q1) @ $T_A = 25^\circ\text{C}$ unless otherwise specified

Characteristic	Symbol	Min	Typ	Max	Unit	Test Conditions
OFF CHARACTERISTICS						
Collector-Base Cut Off Current	I_{CBO}	—	—	-100	nA	$V_{CB} = -50\text{V}, I_E = 0$
Collector-Emitter Cut Off Current	I_{CEO}	—	—	-1	μA	$V_{CE} = -50\text{V}, I_B = 0$
Emitter-Base Cut Off Current	I_{EBO}	—	—	-500	μA	$V_{EB} = -5\text{V}, I_C = 0$
Collector-Base Breakdown Voltage	$V_{(BR)CBO}$	-50	—	—	V	$I_C = -10\ \mu\text{A}, I_E = 0$
Collector-Emitter Breakdown Voltage	$V_{(BR)CEO}$	-50	—	—	V	$I_C = -2\ \text{mA}, I_B = 0$
Output Off Voltage	V_{OH}	-4.6	—	—	V	$V_{CC} = -5\text{V}, V_B = -0.05\text{V}, R_L = 1\text{K}\Omega$
Input Off Voltage	$V_{I(OFF)}$	—	-0.71	-0.5	V	$V_{CE} = -5\text{V}, I_C = -100\ \mu\text{A}$
Output Off Current	$I_{O(OFF)}$	—	—	-1	μA	$V_{CC} = -50\text{V}, V_I = 0\text{V}$
ON CHARACTERISTICS						
Collector-Emitter Saturation Voltage	$V_{CE(SAT)}$	—	-0.066	-0.1	V	$I_C = 5\ \text{mA}, I_B = -0.25\ \text{mA}$
		—	-0.078	-0.1		$I_C = -10\ \text{mA}, I_B = -0.3\ \text{mA}$
		—	-0.06	-0.1		$I_C = -10\ \text{mA}, I_B = -1\ \text{mA}$
		—	-0.04	-0.1		$I_C = -10\ \text{mA}, I_B = -5\ \text{mA}$
		—	-0.99	-1.15		$I_C = -100\ \text{mA}, I_B = -5\ \text{mA}$
		—	0.99	-1.15		$I_C = -100\ \text{mA}, I_B = -10\ \text{mA}$
Equivalent on-resistance*	$R_{CE(SAT)}$	—	—	3.5	Ω	$I_C = -100\ \text{mA}, I_B = -10\ \text{mA}$
DC Current Gain	h_{FE}	50	—	—	—	$V_{CE} = -5\text{V}, I_C = -1\ \text{mA}$
		130	—	—	—	$V_{CE} = -5\text{V}, I_C = -5\ \text{mA}$
		180	—	—	—	$V_{CE} = -5\text{V}, I_C = -50\ \text{mA}$
		100	—	—	—	$V_{CE} = -5\text{V}, I_C = -100\ \text{mA}$
		140	—	—	—	$V_{CE} = -10\text{V}, I_C = -5\ \text{mA}$
Output On Voltage	V_{OL}	—	-0.185	-0.22	V	$V_{CC} = -5\text{V}, V_B = -2.5\text{V}, R_L = 1\text{K}\Omega$
Input On Voltage (Load is on)	$V_{I(ON)}$	-1.25	-0.9	—	V	$V_O = -0.3\text{V}, I_C = -2\ \text{mA}$
Input Current	I_i	—	—	-0.88	mA	$V_I = -5\text{V}$
Base-Emitter Turn-on Voltage	$V_{BE(ON)}$	—	-0.72	-0.8	V	$V_{CE} = -5\text{V}, I_C = 100\ \mu\text{A}$
Base-Emitter Saturation Voltage	$V_{BE(SAT)}$	—	-1.15	-1.25	V	$I_C = 1\ \text{mA}, I_B = 50\ \mu\text{A}$
Input Resistor +/- 30% (Base)	$\Delta R1$	7	10	13	$\text{K}\Omega$	—
Pull-up Resistor (Base to V_{CC} supply)	R2	32	47	62	$\text{K}\Omega$	—
Resistor Ratio	$\Delta(R2/R1)$	20	—	20	%	—

Electrical Characteristics: Pre-Biased PNP Transistor (Q1) (Continued)

SMALL SIGNAL CHARACTERISTICS						
Transition Frequency (gain bandwidth product)	f_T	—	200	—	MHz	$V_{CE} = -10V, I_E = -5mA, f = 100MHz$
Collector capacitance (C _{cb} -Output Capacitance)	C_C	—	5	—	pF	$V_{CB} = -10V, I_E = 0A, f = 1MHz$

*Pulse Test: Pulse width, $t_p < 300 \mu s$, Duty Cycle, $d < 0.02$

Pre-Biased NPN Transistor (Q2) @ $T_A = 25^\circ C$ unless otherwise specified

Characteristic	Symbol	Min	Typ	Max	Unit	Test Conditions
OFF CHARACTERISTICS						
Collector-Base Cut Off Current	I_{CBO}	—	—	100	nA	$V_{CB} = 50V, I_E = 0$
Collector-Emitter Cut Off Current	I_{CEO}	—	—	1	μA	$V_{CE} = 50V, I_B = 0$
Emitter-Base Cut Off Current	I_{EBO}	—	—	500	μA	$V_{EB} = 5V, I_C = 0$
Collector-Base Breakdown Voltage	$V_{(BR)CBO}$	50	—	—	V	$I_C = 10 \mu A, I_E = 0$
Collector-Emitter Breakdown Voltage	$V_{(BR)CEO}$	50	—	—	V	$I_C = 2 mA, I_B = 0$
Output Off Voltage	V_{OH}	4.6	—	—	V	$V_{CC} = 5V, V_B = 0.05V, R_L = 1K\Omega$
Input Off Voltage	$V_{I(OFF)}$	—	1.2	0.8	V	$V_{CE} = 5V, I_C = 100\mu A$
Output Current	$I_{O(OFF)}$	—	—	1	μA	$V_{CC} = 50V, V_I = 0V$
ON CHARACTERISTICS						
Collector-Emitter Saturation Voltage	$V_{CE(SAT)}$	—	0.06	0.1	V	$I_C = 5 mA, I_B = 0.25 mA$
		—	0.06	0.1		$I_C = 10mA, I_B = 0.5mA$
		—	0.042	0.06		$I_C = 10mA, I_B = 1mA$
		—	0.026	0.04		$I_C = 10mA, I_B = 5mA$
		—	0.272	0.35		$I_C = 100mA, I_B = 5mA$
		—	0.28	0.35		$I_C = 100mA, I_B = 10mA$
Equivalent on-resistance*	$R_{CE(SAT)}$	—	—	3.5	Ω	$I_C = 100mA, I_B = 10mA$
DC Current Gain	h_{FE}	12	—	—	—	$V_{CE} = 5V, I_C = 1 mA$
		45	—	—	—	$V_{CE} = 5V, I_C = 5 mA$
		130	—	—	—	$V_{CE} = 5V, I_C = 50 mA$
		70	—	—	—	$V_{CE} = 5V, I_C = 100 mA$
		40	58	—	—	$V_{CE} = 10V, I_C = 5 mA$
Output On Voltage	V_{OL}	—	0.12	0.2	V	$V_{CC} = 5V, V_B = 2.5V, R_L = 1K\Omega$
Input On Voltage	$V_{I(ON)}$	2.8	1.6	—	V	$V_O = 0.3V, I_C = 2 mA$
Input Current	I_i	—	—	0.88	mA	$V_I = 5V$
Base-Emitter Turn-on Voltage	$V_{BE(ON)}$	—	—	1.195	V	$V_{CE} = 5V, I_C = 100\mu A$
Base-Emitter Saturation Voltage	$V_{BE(SAT)}$	—	—	1.02	V	$I_C = 1mA, I_B = 50\mu A$
Input Resistor +/- 30% (Base)	R_1	7	10	13	$K\Omega$	—
Resistor Ratio	(R_2/R_1)	0.8	1	1.2	—	—
SMALL SIGNAL CHARACTERISTICS						
Transition Frequency (Gain bandwidth product)	f_T	—	250	—	MHz	$V_{CE} = 10V, I_E = 5mA, f = 100MHz$
Collector capacitance (C _{cb} -Output Capacitance)	C_C	—	4	—	pF	$V_{CB} = 10V, I_E = 0A, f = 1MHz$

*Pulse Test: Pulse width, $t_p < 300 \mu s$, Duty Cycle, $d < 0.02$

Typical Characteristics @ $T_{amb} = 25^{\circ}\text{C}$ unless otherwise specified

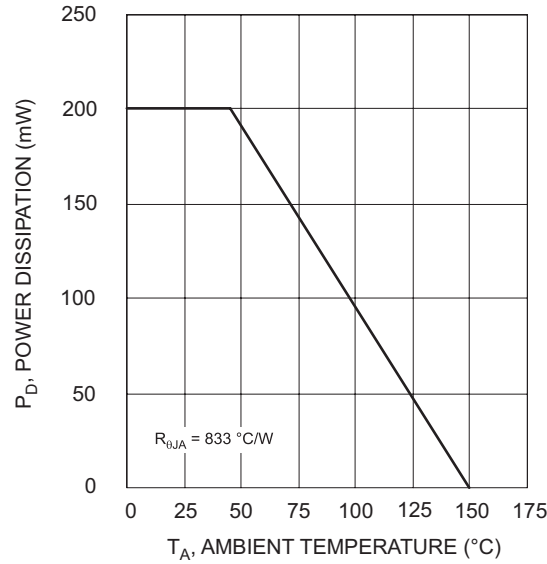

Characteristics Curves of PNP Transistor (Q1) @ $T_{amb} = 25^{\circ}\text{C}$ unless otherwise specified

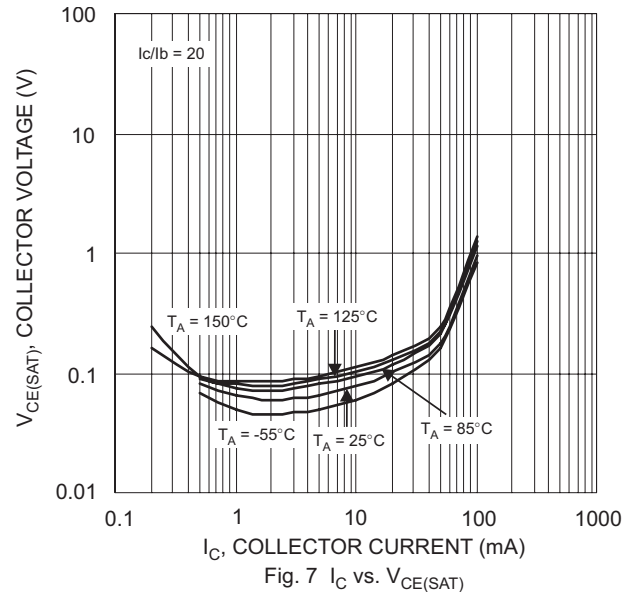
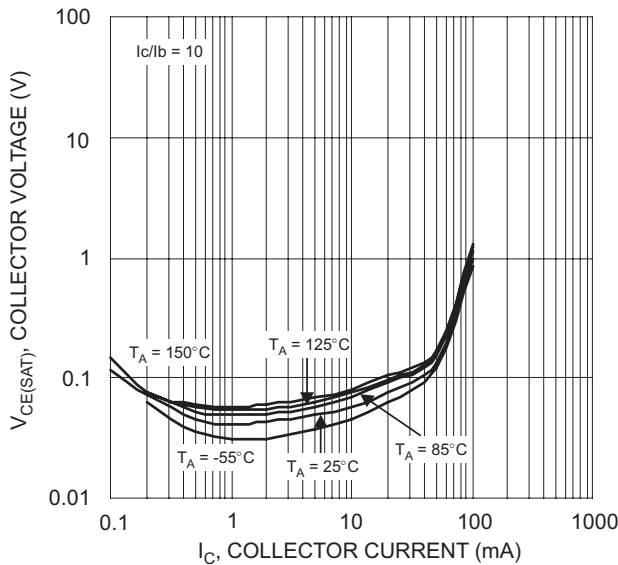
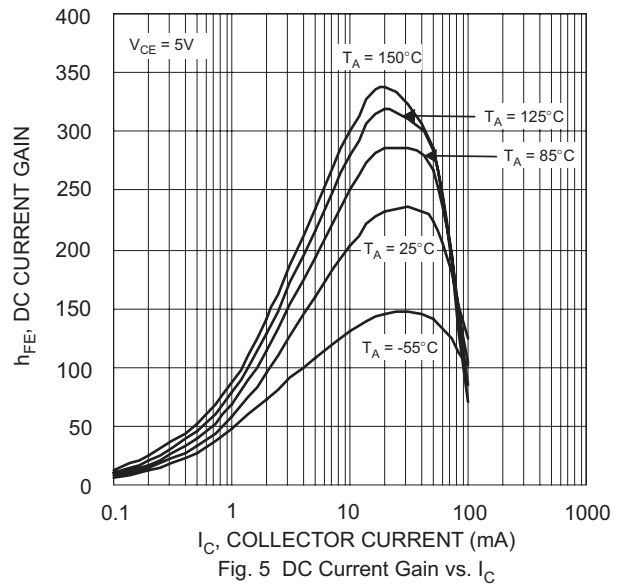
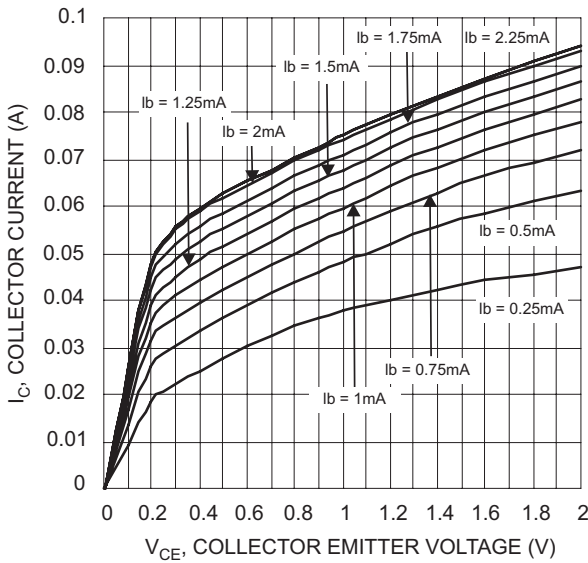

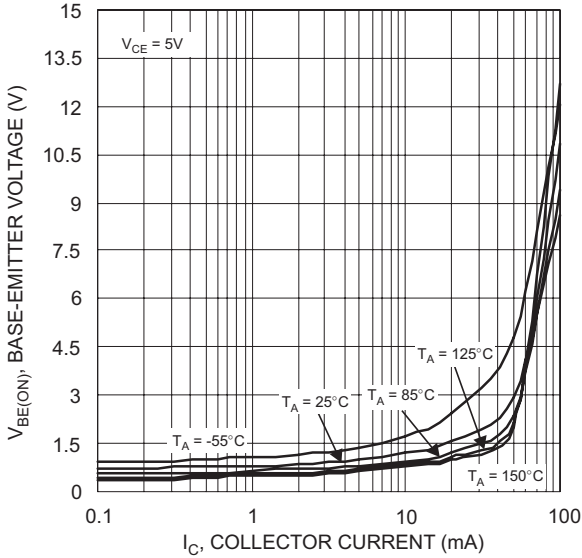

Fig. 8 I_C vs. $V_{BE(ON)}$

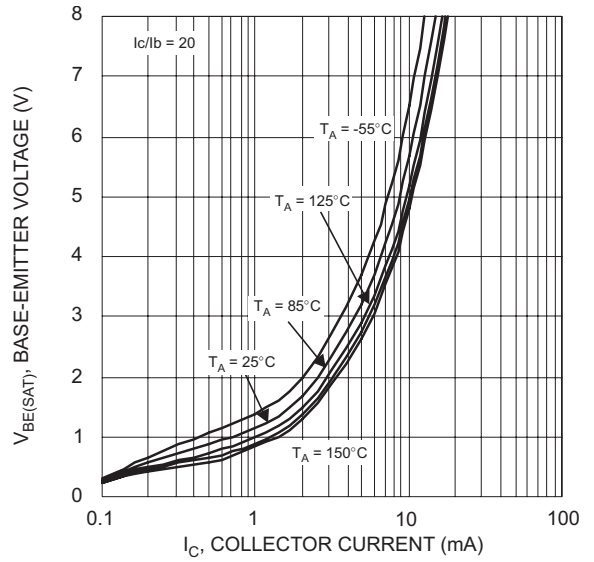

Fig. 9 I_C vs. $V_{BE(SAT)}$

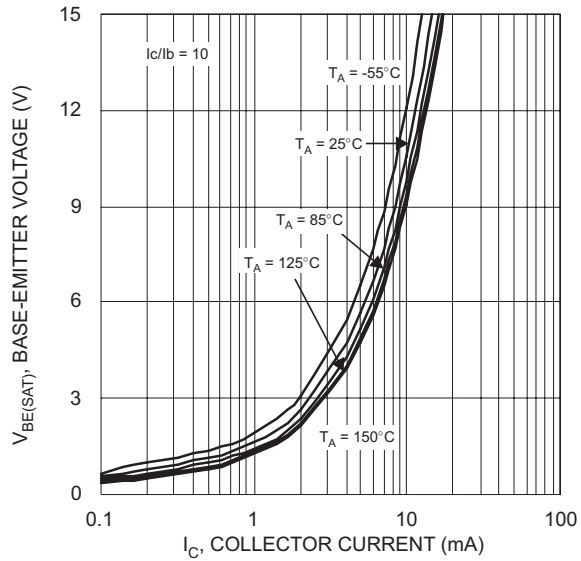

Fig. 10 I_C vs. $V_{BE(SAT)}$

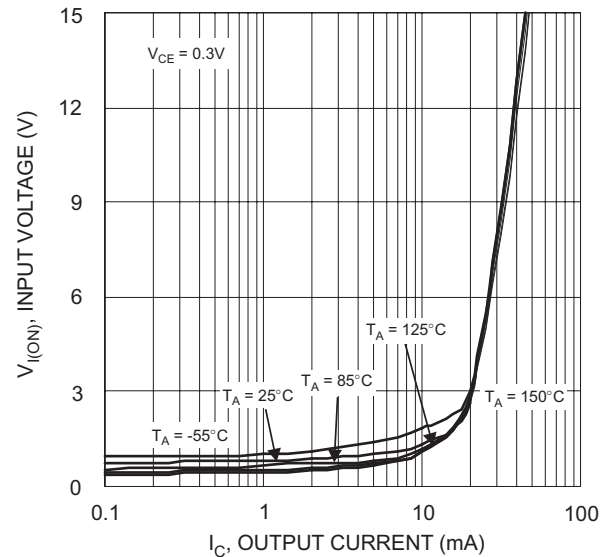

Fig. 11 Input Voltage vs. Collector Current

Characteristics Curves of NPN Transistor (Q2) @ $T_{amb} = 25^\circ\text{C}$ unless otherwise specified

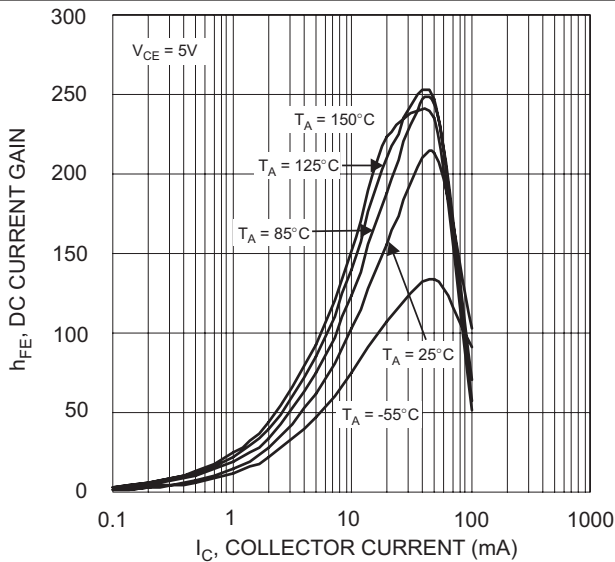

Fig. 12 DC Current Gain vs. I_C

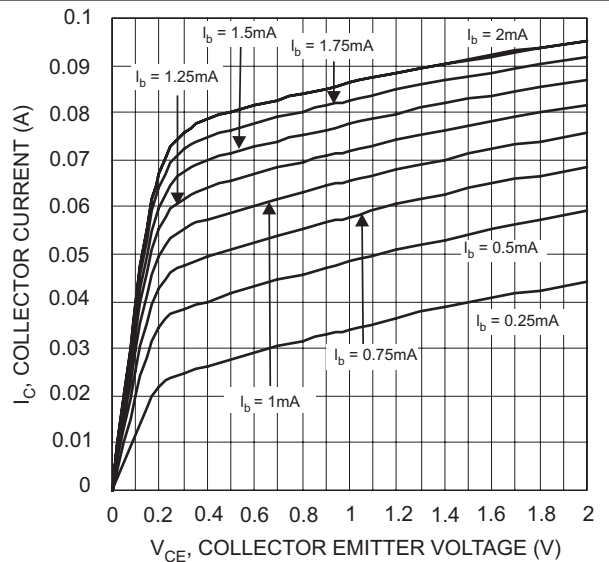

Fig. 13 V_{CE} vs. I_C

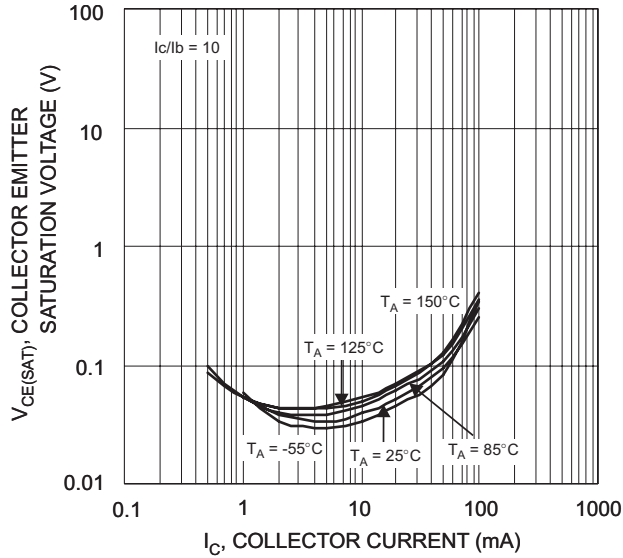

Fig. 14 I_C vs. $V_{CE(SAT)}$

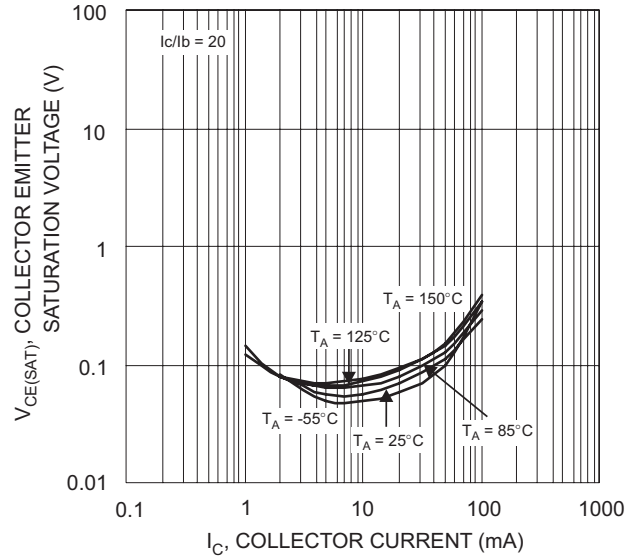

Fig. 15 I_C vs. $V_{CE(SAT)}$

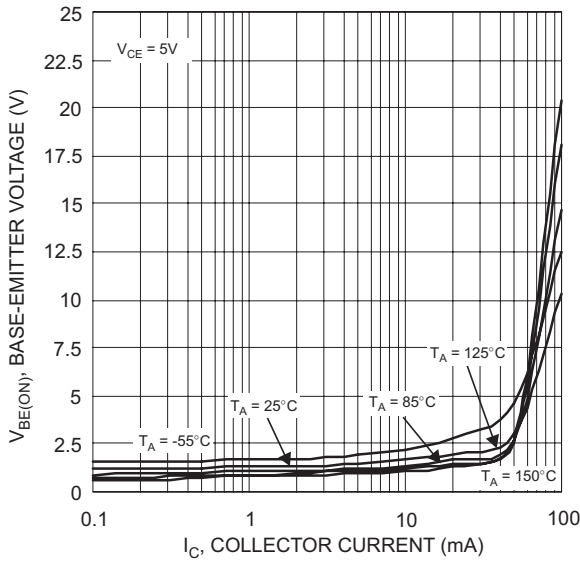

Fig. 16 I_C vs. $V_{BE(ON)}$

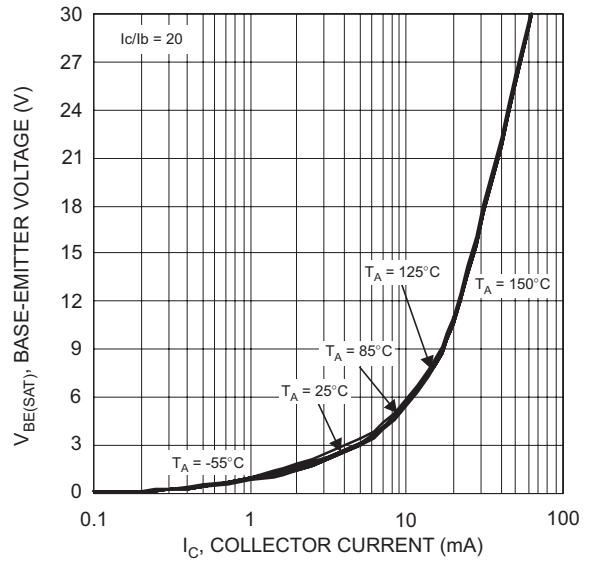

Fig. 17 I_C vs. $V_{BE(SAT)}$

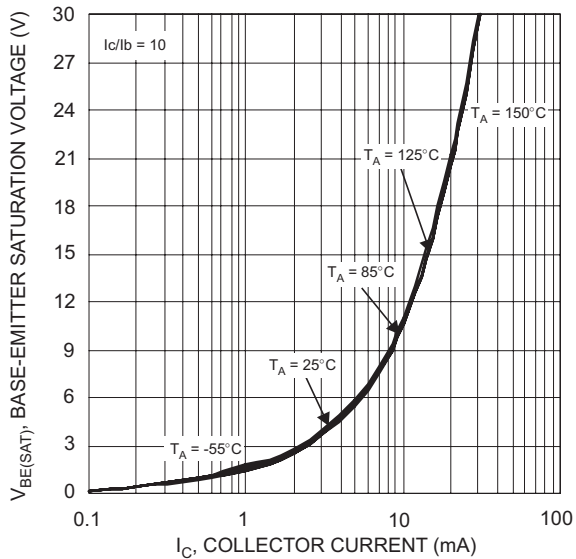

Fig. 18 I_C vs. $V_{BE(SAT)}$

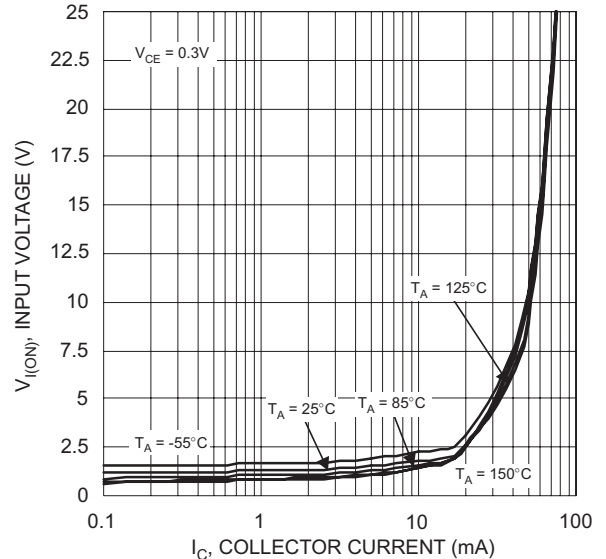

Fig. 19 Input Voltage vs. Output Current

Ordering Information (Note 5)

Device	Marking Code	Packaging	Shipping
DCX4710H-7	C02	SOT-563	3000/Tape & Reel

Notes: 5. For Packaging Details, go to our website at <http://www.diodes.com/datasheets/ap02007.pdf>.

Marking Information

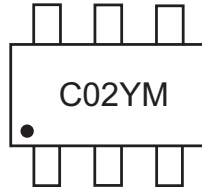

Fig. 20

C02 = Product Type Marking Code
 YM = Date Code Marking
 Y = Year e.g., T = 2006
 M = Month e.g., 9 = September

Date Code Key

Year				2006	2007	2008	2009
Code				T	U	V	W

Month	Jan	Feb	March	Apr	May	Jun	Jul	Aug	Sep	Oct	Nov	Dec
Code	1	2	3	4	5	6	7	8	9	O	N	D

Mechanical Details

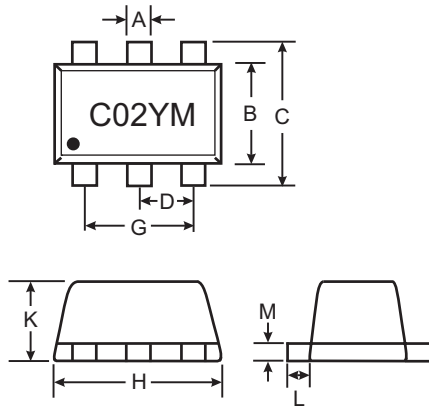

Fig. 21

SOT-563			
Dim	Min	Max	Typ
A	0.15	0.3	0.25
B	1.1	1.25	1.2
C	1.55	1.7	1.6
D	0.5		
G	0.9	1.1	1
H	1.5	1.7	1.6
K	0.56	0.6	0.6
L	0.15	0.25	0.2
M	0.1	0.18	0.11
All Dimensions in mm			

Suggested Pad Layout: (Based on IPC-SM-782)

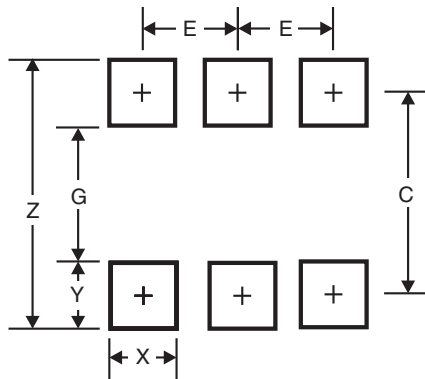

Fig. 22

Figure 4 Dimensions	SOT-563
Z	2.2
G	1.2
X	0.375
Y	0.5
C	1.7
E	0.5

IMPORTANT NOTICE

Diodes Incorporated and its subsidiaries reserve the right to make modifications, enhancements, improvements, corrections or other changes without further notice to any product herein. Diodes Incorporated does not assume any liability arising out of the application or use of any product described herein; neither does it convey any license under its patent rights, nor the rights of others. The user of products in such applications shall assume all risks of such use and will agree to hold Diodes Incorporated and all the companies whose products are represented on our website, harmless against all damages.

LIFE SUPPORT

Diodes Incorporated products are not authorized for use as critical components in life support devices or systems without the expressed written approval of the President of Diodes Incorporated.