

TFT COLOR LCD MODULE

NL6448BC33-54

26.4cm (10.4 Type)

VGA

DATA SHEET 

DOD-PD-0072 (2nd edition)

**This DATA SHEET is updated document from
DOD-M-1355(1).**

**All information is subject to change without notice.
Please confirm the sales representative before
starting to design your system.**

INTRODUCTION

No part of this document shall be copied in any form or by any means without the prior written consent of NEC LCD Technologies, Ltd. (hereinafter called "NEC").

NEC does not assume any liability for infringement of patents, copyrights or other intellectual property rights of third parties by or arising from use of a product described herein or any other liability arising from use of such application. No license, express, implied or otherwise, is granted under any patents, copyrights or other intellectual property rights of NEC or of others.

While NEC has been making continuous effort to enhance the reliability of its products, the possibility of failures cannot be eliminated entirely. To minimize risks of damage to property or injury to person arising from a failure in an NEC product, customers must incorporate sufficient safety measures in their design, such as redundancy, fire-containment and anti-failure features.

NEC products are classified into the following three quality grades:

"Standard", "Special", "Specific"

The *"Specific"* quality grade applies only to applications developed based on a customer designated "quality assurance program" for a specific application. The recommended applications of a product depend on its quality grade, as indicated below. Customers must check the quality grade of each application before using it in a particular application.

Standard: Computers, office equipment, communications equipment, test and measurement equipment, audio and visual equipment, home electronic appliances, machine tools, personal electronic equipment and industrial robots

Special: Transportation equipment (automobiles, trains, ships, etc.), traffic control systems, anti-disaster systems, anti-crime systems, safety equipment and medical equipment (not specifically designed for life support)

Specific: Military systems, aircraft, aerospace equipment, submersible repeaters, nuclear reactor control systems, life support systems (medical equipment, etc.) and any other equipment

The quality grade of this product is *"Standard"* unless otherwise specified in this document. If customers intend to use this product for applications other than those specified for *"Standard"* quality grade, they should contact NEC sales representative in advance.

CONTENTS

INTRODUCTION2

1. OUTLINE.....4

 1.1 STRUCTURE AND PRINCIPLE.....4

 1.2 APPLICATIONS.....4

 1.3 FEATURES.....4

2. GENERAL SPECIFICATIONS5

3. BLOCK DIAGRAM.....6

4. DETAILED SPECIFICATIONS7

 4.1 MECHANICAL SPECIFICATIONS.....7

 4.2 ABSOLUTE MAXIMUM RATINGS7

 4.3 ELECTRICAL CHARACTERISTICS8

 4.3.1 Driving for LCD panel signal processing board8

 4.3.2 Working for backlight lamp9

 4.3.3 Power supply voltage ripple.....10

 4.3.4 Fuse.....10

 4.4 POWER SUPPLY VOLTAGE SEQUENCE11

 4.4.1 Sequence for LCD panel signal processing board11

 4.4.2 Sequence for backlight inverter (Option).....11

 4.5 CONNECTIONS AND FUNCTIONS FOR INTERFACE PINS.....12

 4.5.1 LCD panel signal processing board12

 4.5.2 Backlight lamp.....13

 4.5.3 Positions of plugs and a socket.....13

 4.6 DISPLAY COLORS AND INPUT DATA SIGNALS14

 4.7 DISPLAY POSITIONS.....15

 4.8 SCANNING DIRECTIONS15

 4.9 INPUT SIGNAL TIMINGS FOR LCD PANEL SIGNAL PROCESSING BOARD16

 4.9.1 Outline of input signal timings16

 4.9.2 Timing characteristics17

 4.9.3 Input signal timing chart19

 4.10 OPTICS.....22

 4.10.1 Optical characteristics for transmissive mode.....22

 4.10.2 Definition of contrast ratio.....23

 4.10.3 Definition of luminance uniformity23

 4.10.4 Definition of response times23

 4.10.5 Definition of viewing angles.....23

5. RELIABILITY TESTS.....24

6. PRECAUTIONS25

 6.1 MEANING OF CAUTION SIGNS25

 6.2 CAUTIONS25

 6.3 ATTENTIONS25

 6.3.1 Handling of the product25

 6.3.2 Environment.....26

 6.3.3 Characteristics.....26

 6.3.4 Other26

7. OUTLINE DRAWINGS27

 7.1 FRONT VIEW27

 7.2 REAR VIEW28

1. OUTLINE

1.1 STRUCTURE AND PRINCIPLE

NL6448BC33-54 module is composed of the amorphous silicon thin film transistor liquid crystal display (a-Si TFT LCD) panel structure with driver LSIs for driving the TFT (Thin Film Transistor) array and a backlight.

The a-Si TFT LCD panel structure is injected liquid crystal material into a narrow gap between the TFT array glass substrate and a color-filter glass substrate.

Color (Red, Green, Blue) data signals from a host system (e.g. PC, signal generator, etc.) are modulated into best form for active matrix system by a signal processing board, and sent to the driver LSIs which drive the individual TFT arrays.

The TFT array as an electro-optical switch regulates the amount of transmitted light from the backlight assembly, when it is controlled by data signals. Color images are created by regulating the amount of transmitted light through the TFT array of red, green and blue dots.

1.2 APPLICATIONS

- Display terminal for control system
- Industrial PC

1.3 FEATURES

- High luminance
- High contrast
- 6-bit digital RGB signals
- DE (Data enable) function
- Reversible-scan direction
- Edge light type (Inverter less)
- Replaceable lamp for backlight
- Acquisition product for UL60950 3rd edition/CSA C22.2 No.60950 (File number: E170632)

2. GENERAL SPECIFICATIONS

| | |
|-----------------------------------|-------------------------------------------------------------------------------------------------------------------------------------------------------------------------------------------------------------------------------------------------------------------------------------------------------------------------------------------------------------------------------------------------------------------------------------------------------------------------------------------------------------------------------------------------------------------------------------------------------------------------------------------------------------------------------------------------------------------------|
| Display area | 211.2 (W) × 158.4 (H) mm (typ.) |
| Diagonal size of display | 26 cm (10.4 inches) |
| Drive system | a-Si TFT active matrix |
| Display color | 262,144 colors |
| Pixel | 640 (H) × 480 (V) pixels |
| Pixel arrangement | RGB (Red dot, Green dot, Blue dot) vertical stripe |
| Dot pitch | 0.11 (W) × 0.33 (H) mm |
| Pixel pitch | 0.33 (W) × 0.33 (H) mm |
| Module size | 243.0 (W) × 185.1 (H) × 10.5 (D) mm (typ.) |
| Weight | 465 g (typ.) |
| Contrast ratio | 350:1 (typ.) |
| Viewing angle | At the contrast ratio 10:1 <ul style="list-style-type: none"> • Horizontal: Right side 45° (typ.), Left side 45° (typ.) • Vertical: Up side 30° (typ.), Down side 20° (typ.) |
| Designed viewing direction | At DPS= Low or Open: Normal scan <ul style="list-style-type: none"> • Viewing direction without image reversal: down side (6 o'clock) • Viewing direction with contrast peak: normal axis • Viewing angle with optimum grayscale ($\gamma=2.2$): normal axis |
| Polarizer surface | Clear |
| Polarizer pencil-hardness | 3H (min.) [by JIS K5400] |
| Color gamut | At LCD panel center 40 % (typ.) [against NTSC color space] |
| Response time | Ton (white 90%→ black 10%) 15 ms (typ.) |
| Luminance | At IBL= 5.0mAmps / lamp 220 cd/m ² (typ.) |
| Signal system | 6-bit digital signals for data of RGB colors, Dot clock (CLK), Data enable (DE), Horizontal synchronous signal (Hsync), Vertical synchronous signal (Vsync) |
| Power supply voltage | LCD panel signal processing board: 3.3V or 5.0V |
| Backlight | Edge light type: 2 cold cathode fluorescent lamps <div style="display: flex; align-items: center; margin-top: 10px;"> <div style="font-size: 2em; margin-right: 5px;">{</div> <div style="margin-right: 5px;">Replaceable part</div> <div style="margin-right: 5px;">}</div> <ul style="list-style-type: none"> • Lamp holder set: Type No. 104LHS35 </div> <div style="display: flex; align-items: center; margin-top: 10px;"> <div style="font-size: 2em; margin-right: 5px;">{</div> <div style="margin-right: 5px;">Recommended inverter (Option)</div> <div style="margin-right: 5px;">}</div> <ul style="list-style-type: none"> • Inverter: Type No.: 104PW161, 104PW191 </div> |
| Power consumption | At IBL= 5.0mAmps / lamp and checkered flag pattern 5.8 W (typ.) |

3. BLOCK DIAGRAM

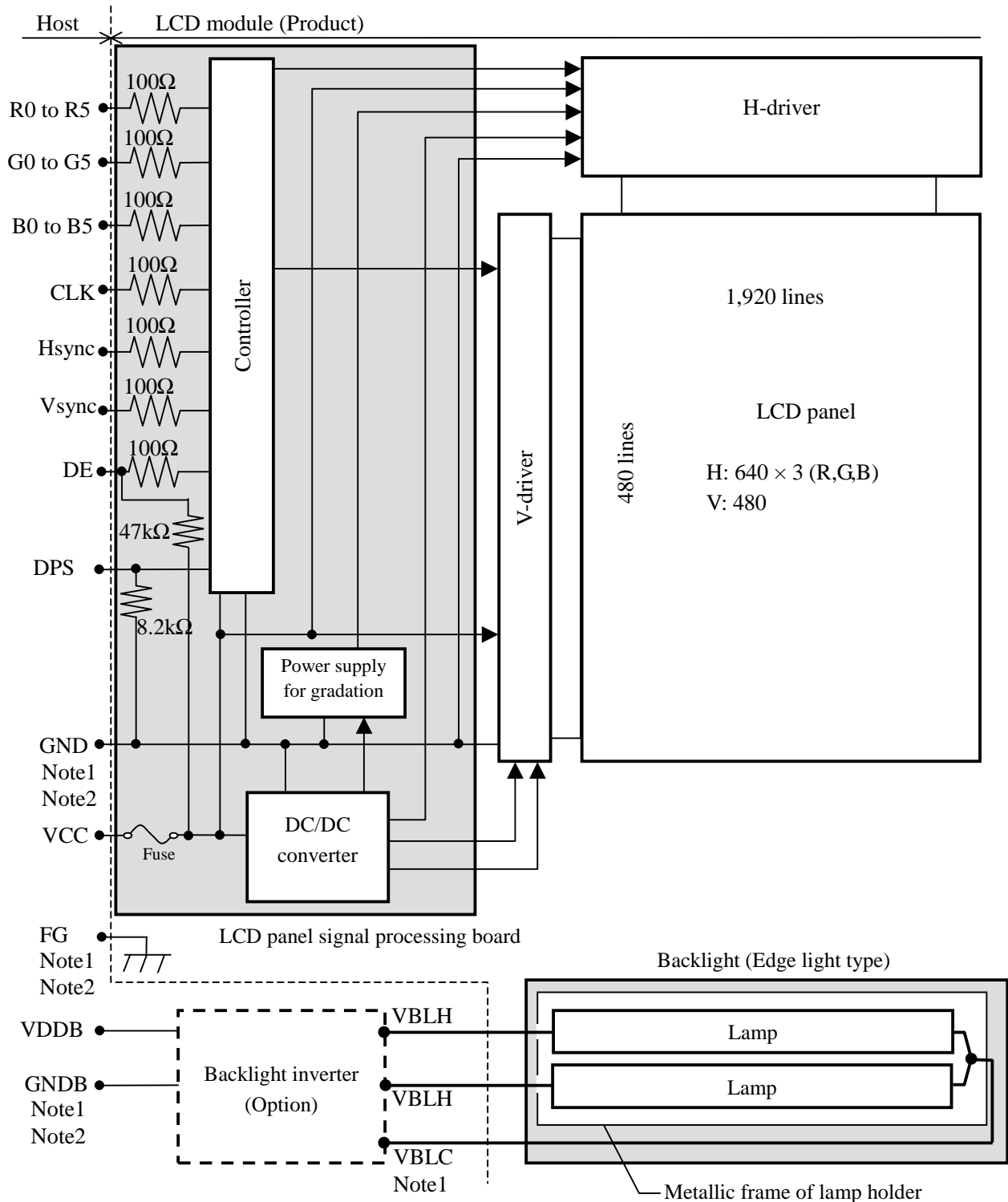

Note1: Connections between GND (Signal ground), FG (Frame ground) and VBLC (Lamp low voltage terminal) in the LCD module

| | |
|------------|---------------|
| GND - FG | Not connected |
| GND - VBLC | Not connected |
| FG - VBLC | Not connected |

Note2: These grounds should be connected together in customer equipment.

4. DETAILED SPECIFICATIONS

4.1 MECHANICAL SPECIFICATIONS

| Parameter | Specification | Unit |
|--------------|----------------------------------------------------------|------|
| Module size | 243.0 ± 0.5 (W) × 185.1 ± 0.5 (H) × 10.5 ± 0.5 (D) Note1 | mm |
| Display area | 211.2 (W) × 158.4 (H) Note1 | mm |
| Weight | 465 (typ.), 490 (max.) | g |

Note1: See "7. OUTLINE DRAWINGS".

4.2 ABSOLUTE MAXIMUM RATINGS

| Parameter | | Symbol | Rating | Unit | Remarks |
|---------------------------|-----------------------------------|--------|-----------------|------------------|----------------|
| Power supply voltage | LCD panel signal processing board | VCC | -0.3 to +6.5 | V | Ta = 25°C |
| | Lamp voltage | VBLH | 1,500 | Vrms | |
| Input voltage for signals | Display signals Note1 | VD | -0.3 to VCC+0.3 | V | |
| | Function signal Note2 | VF | -0.3 to VCC+0.3 | V | |
| Storage temperature | | Tst | -20 to +80 | °C | - |
| Operating temperature | Front surface | TopF | -10 to +70 | °C | Note3 |
| | Rear surface | TopR | -10 to +70 | °C | Note4 |
| Relative humidity Note5 | | RH | ≤ 95 | % | Ta ≤ 40°C |
| | | | ≤ 85 | % | 40 < Ta ≤ 50°C |
| Absolute humidity Note5 | | AH | ≤ 70 Note6 | g/m ³ | Ta > 50°C |

Note1: Display signals are CLK, Hsync, Vsync, DE, R0 to R5, G0 to G5 and B0 to B5.

Note2: Function signal is DPS.

Note3: Measured at center of LCD panel surface (including self-heat)

Note4: Measured at center of LCD module's rear shield surface (including self-heat)

Note5: No condensation

Note6: Ta = 50°C, RH = 85%

4.3 ELECTRICAL CHARACTERISTICS

4.3.1 Driving for LCD panel signal processing board

(Ta = 25°C)

| Parameter | Symbol | min. | typ. | max. | Unit | Remarks |
|-----------------------------------------|--------|------|--------------|--------------|--------|---------------|
| Power supply voltage | VCC | 3.0 | 3.3 | 3.6 | V | at VCC = 3.3V |
| | | 4.75 | 5.0 | 5.25 | V | at VCC = 5.0V |
| Power supply current | ICC | - | 180 Note1 | 300 Note2 | mA | at VCC = 3.3V |
| | | - | 120 Note1 | 200 Note2 | mA | at VCC = 5.0V |
| Logic input voltage for display signals | Low | VDL | 0 | - | 0.3VCC | CMOS level |
| | High | VDH | 0.7VCC | - | VCC | |
| Input voltage for DPS signal | Low | VFL | 0 | - | 0.3VCC | |
| | High | VFH | 0.7VCC | - | VCC | |

Note1: Checkered flag pattern [by EIAJ ED-2522]

Note2: Pattern for maximum current

4.3.2 Working for backlight lamp

(Ta=25°C, Note1)

| Parameter | Symbol | min. | typ. | max. | Unit | Remarks |
|-----------------------|--------|------|------|------|-------|----------------------------------------------------------|
| Lamp current | IBL | 2.0 | 5.0 | 5.5 | mArms | at IBL=5.0mArms: 220cd/m ² Note3, Note4 |
| Lamp voltage | VBLH | - | 520 | - | Vrms | Note2, Note3 |
| Lamp starting voltage | VS | 850 | - | - | Vrms | Ta = 25°C Note2, Note3 |
| | | 1100 | - | - | Vrms | Ta = -10°C Note2, Note3 |
| Oscillation frequency | FO | 50 | - | 70 | kHz | Note5 |

Note1: This product's backlight consists of 2 lamps, and these specifications are for each lamp.

Note2: The lamp voltage cycle between lamps should be kept on a same phase. "VS" and "VBLH" are the voltage value between low voltage side (Cold) and high voltage side (Hot).

Note3: The asymmetric ratio of working waveform for lamps (Lamp voltage peak ratio, Lamp current peak ratio and waveform space ratio) should be less than 5 % (See the following figure.). If the waveform is asymmetric, DC (Direct current) element apply into the lamp. In this case, a lamp lifetime may be shortened, because a distribution of a lamp enclosure substance inclines toward one side between low voltage terminal (Cold terminal) and high voltage terminal (Hot terminal).

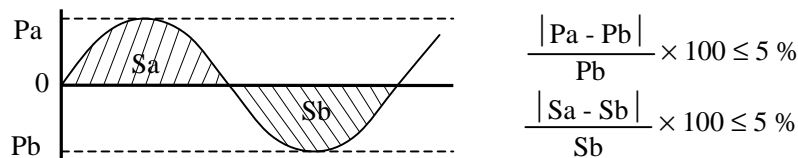

Pa: Supply voltage/current peak for positive, Pb: Supply voltage/current peak for negative
Sa: Waveform space for positive part, Sb: Waveform space for negative part

Note4: This product consists of 2 lamps. 2 lamps contain in the 1 lamp holder, and both lamps are connected to 1 low voltage cable. Lamp current must be 5.0mArms typical for each lamp, and sum of 2 lamps must be 10mArms typical. The lamp current should be measured by high-frequency current meter at the low voltage terminal.

Note5: In case "FO" is not the recommended value, beat noise may display on the screen, because of interference between "FO" and "1/th". Recommended value of "FO" is as following.

$$FO = \frac{1}{4} \times \frac{1}{th} \times (2n-1)$$

th: Horizontal synchronous cycle (See "4.9 INPUT SIGNAL TIMINGS FOR LCD PANEL SIGNAL PROCESSING BOARD".)

n: Natural number (1, 2, 3)

Note6: Method of lamp cable installation may invite fluctuation of lamp current and voltage or asymmetric of lamp working waveform. When designing method of lamp cable installation, evaluate the fluctuation of lamp current, voltage and working waveform sufficiently.

4.3.3 Power supply voltage ripple

This product works, even if the ripple voltage levels are beyond the permissible values as following the table, but there might be noise on the display image.

| Parameter | Power supply voltage | Ripple voltage (Measure at input terminal of power supply) | Note1 | Unit |
|-----------|----------------------|---------------------------------------------------------------|-------|-------|
| VCC | 3.3 V | ≤ 100 | | mVp-p |
| | 5.0 V | ≤ 100 | | mVp-p |

Note1: The permissible ripple voltage includes spike noise.

4.3.4 Fuse

| Parameter | Fuse | | Rating | Fusing current | Remarks |
|-----------|------------|------------------------------|--------|----------------|---------|
| | Type | Supplier | | | |
| VCC | FCC16162AB | KAMAYA ELECTRIC Co., Ltd. | 1.6A | 3.2A | Note1 |
| | | | 32V | | |

Note1: The power supply capacity should be more than the fusing current. If the power supply capacity is less than the fusing current, the fuse may not blow for a short time, and then nasty smell, smoking and so on may occur.

4.4 POWER SUPPLY VOLTAGE SEQUENCE

4.4.1 Sequence for LCD panel signal processing board

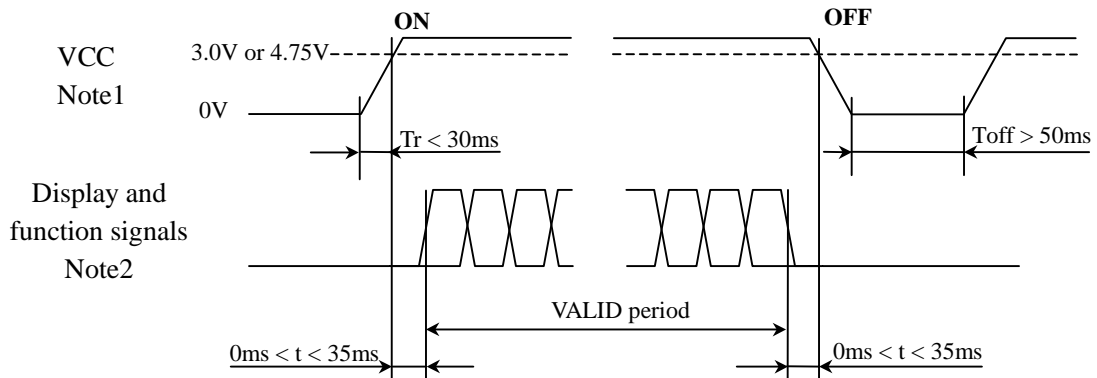

Note1: In terms of voltage variation (voltage drop) while VCC rising edge is below 3.0V in "VCC = 3.3V" or 4.75V in "VCC = 5.0V", a protection circuit may work, and then this product may not work.

Note2: Display (CLK, Hsync, Vsync, DE, R0 to R5, G0 to G5, B0 to B5) and function (DPS) signal must be Low or High-impedance, exclude the VALID period (See above sequence diagram), in order to avoid that internal circuits is damaged.

If some of display and function signals of this product are cut while this product is working, even if the signal input to it once again, it might not work normally. If customer stops the display and function signals, they should be cut VCC.

4.4.2 Sequence for backlight inverter (Option)

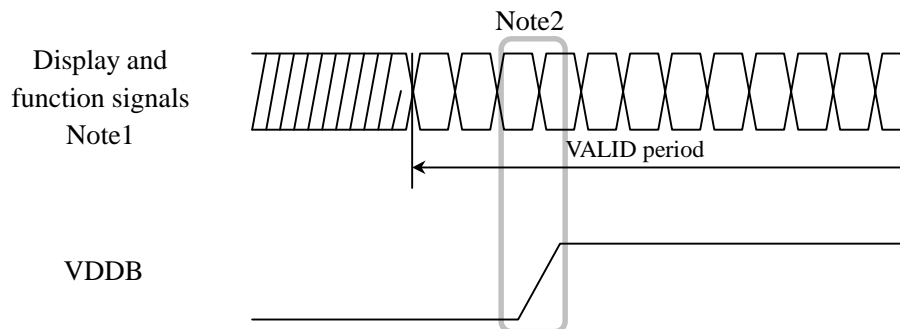

Note1: These are the display and function signals for LCD panel signal processing board.

Note2: The backlight inverter voltage (VDDB) should be inputted within the valid period of display and function signals, in order to avoid unstable data display.

4.5 CONNECTIONS AND FUNCTIONS FOR INTERFACE PINS

4.5.1 LCD panel signal processing board

CN1 socket (LCD module side): DF9C-31P-1V (Hirose Electric Co., Ltd.)

Adaptable plug: DF9-31S-1V (Hirose Electric Co., Ltd.)

| Pin No. | Symbol | Signal | Remarks |
|---------|--------|------------------------------|---------------------------------------------------------------|
| 1 | GND | Ground | |
| 2 | CLK | Dot clock | |
| 3 | Hsync | Horizontal synchronous | - |
| 4 | Vsync | Vertical synchronous | |
| 5 | GND | Ground | |
| 6 | R0 | Red data (LSB) | Least significant bit |
| 7 | R1 | Red data | |
| 8 | R2 | Red data | - |
| 9 | R3 | Red data | |
| 10 | R4 | Red data | |
| 11 | R5 | Red data (MSB) | Most significant bit |
| 12 | GND | Ground | - |
| 13 | G0 | Green data (LSB) | Least significant bit |
| 14 | G1 | Green data | |
| 15 | G2 | Green data | - |
| 16 | G3 | Green data | |
| 17 | G4 | Green data | |
| 18 | G5 | Green data (MSB) | Most significant bit |
| 19 | GND | Ground | - |
| 20 | B0 | Blue data (LSB) | Least significant bit |
| 21 | B1 | Blue data | |
| 22 | B2 | Blue data | - |
| 23 | B3 | Blue data | |
| 24 | B4 | Blue data | |
| 25 | B5 | Blue data (MSB) | Most significant bit |
| 26 | GND | Ground | - |
| 27 | DE | Selection of DE / Fixed mode | Data enable signal: DE mode High or Open: Fixed mode Note1 |
| 28 | VCC | Power supply | |
| 29 | VCC | Power supply | - |
| 30 | N.C. | - | Keep this terminal Open. ☆ |
| 31 | DPS | Selection of scan direction | High: Reverse scan Low or Open: Normal scan Note1 |

Note1: See "4.8 SCANNING DIRECTIONS".

4.5.2 Backlight lamp

Attention: VBLH and VBLC must be connected correctly. If customer connects wrongly, customer will be hurt and the module will be broken.

CN2 plug: BHR-03VS-1 (J.S.T Mfg. Co., Ltd.)

Adaptable socket: SM03 (4.0) B-BHS-TB (J.S.T Mfg. Co., Ltd.)

| Pin No. | Symbol | Signal | Remarks |
|---------|--------|--------------------|--------------------|
| 1 | VBLC | Low voltage (Cold) | Cable color: Gray |
| 2 | VBLH | High voltage (Hot) | Cable color: White |
| 3 | VBLH | High voltage (Hot) | Cable color: White |

4.5.3 Positions of plugs and a socket

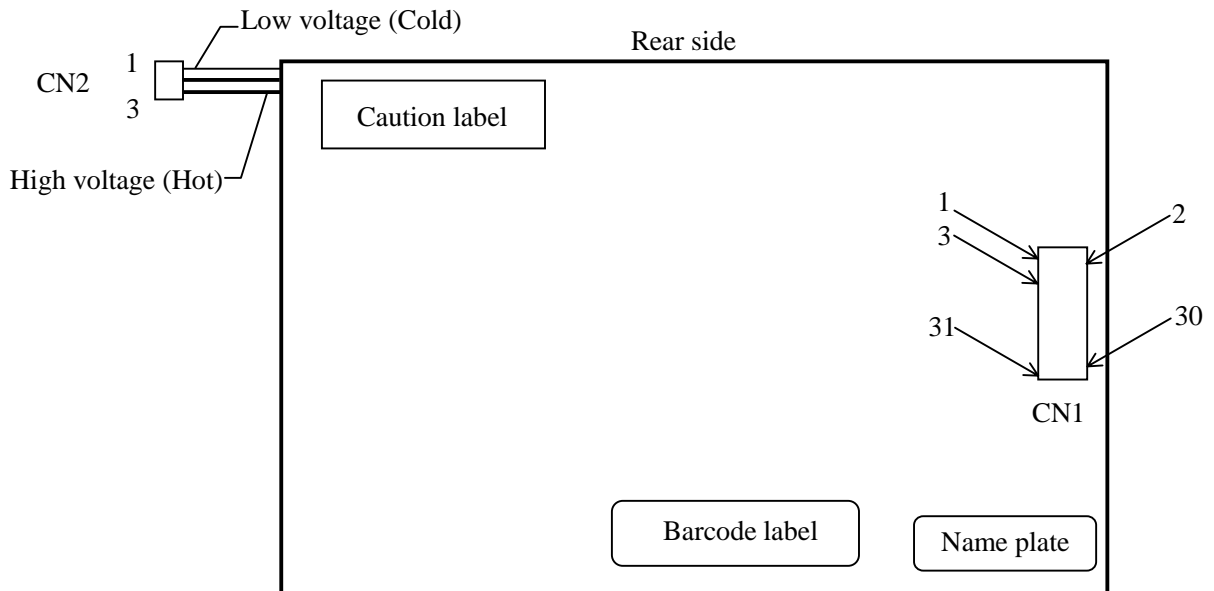

4.6 DISPLAY COLORS AND INPUT DATA SIGNALS

This product can display in equivalent to 262,144 colors in 64 scale. Also the relation between display colors and input data signals is as the following table.

| Display colors | | Data signal (0: Low level, 1: High level) | | | | | | | | | | | | | | | | | |
|----------------|---------|-------------------------------------------|-----|-----|-----|-----|-----|-----|-----|-----|-----|-----|-----|-----|-----|-----|-----|-----|-----|
| | | R 5 | R 4 | R 3 | R 2 | R 1 | R 0 | G 5 | G 4 | G 3 | G 2 | G 1 | G 0 | B 5 | B 4 | B 3 | B 2 | B 1 | B 0 |
| Basic colors | Black | 0 | 0 | 0 | 0 | 0 | 0 | 0 | 0 | 0 | 0 | 0 | 0 | 0 | 0 | 0 | 0 | 0 | 0 |
| | Blue | 0 | 0 | 0 | 0 | 0 | 0 | 0 | 0 | 0 | 0 | 0 | 0 | 1 | 1 | 1 | 1 | 1 | 1 |
| | Red | 1 | 1 | 1 | 1 | 1 | 1 | 0 | 0 | 0 | 0 | 0 | 0 | 0 | 0 | 0 | 0 | 0 | 0 |
| | Magenta | 1 | 1 | 1 | 1 | 1 | 1 | 0 | 0 | 0 | 0 | 0 | 0 | 1 | 1 | 1 | 1 | 1 | 1 |
| | Green | 0 | 0 | 0 | 0 | 0 | 0 | 1 | 1 | 1 | 1 | 1 | 1 | 0 | 0 | 0 | 0 | 0 | 0 |
| | Cyan | 0 | 0 | 0 | 0 | 0 | 0 | 1 | 1 | 1 | 1 | 1 | 1 | 1 | 1 | 1 | 1 | 1 | 1 |
| | Yellow | 1 | 1 | 1 | 1 | 1 | 1 | 1 | 1 | 1 | 1 | 1 | 1 | 0 | 0 | 0 | 0 | 0 | 0 |
| | White | 1 | 1 | 1 | 1 | 1 | 1 | 1 | 1 | 1 | 1 | 1 | 1 | 1 | 1 | 1 | 1 | 1 | 1 |
| Red scale | Black | 0 | 0 | 0 | 0 | 0 | 0 | 0 | 0 | 0 | 0 | 0 | 0 | 0 | 0 | 0 | 0 | 0 | 0 |
| | | 0 | 0 | 0 | 0 | 0 | 1 | 0 | 0 | 0 | 0 | 0 | 0 | 0 | 0 | 0 | 0 | 0 | 0 |
| | dark | 0 | 0 | 0 | 0 | 1 | 0 | 0 | 0 | 0 | 0 | 0 | 0 | 0 | 0 | 0 | 0 | 0 | 0 |
| | ↑ | | | | : | | | | | | | | | | | | : | | |
| | ↓ | | | | : | | | | | | | | | | | | : | | |
| | bright | 1 | 1 | 1 | 1 | 0 | 1 | 0 | 0 | 0 | 0 | 0 | 0 | 0 | 0 | 0 | 0 | 0 | 0 |
| | 1 | 1 | 1 | 1 | 1 | 0 | 0 | 0 | 0 | 0 | 0 | 0 | 0 | 0 | 0 | 0 | 0 | 0 | |
| | 1 | 1 | 1 | 1 | 1 | 1 | 0 | 0 | 0 | 0 | 0 | 0 | 0 | 0 | 0 | 0 | 0 | 0 | |
| Green scale | Black | 0 | 0 | 0 | 0 | 0 | 0 | 0 | 0 | 0 | 0 | 0 | 0 | 0 | 0 | 0 | 0 | 0 | 0 |
| | | 0 | 0 | 0 | 0 | 0 | 0 | 0 | 0 | 0 | 0 | 1 | 0 | 0 | 0 | 0 | 0 | 0 | 0 |
| | dark | 0 | 0 | 0 | 0 | 0 | 0 | 0 | 0 | 0 | 1 | 0 | 0 | 0 | 0 | 0 | 0 | 0 | 0 |
| | ↑ | | | | : | | | | | | | | | | | | : | | |
| | ↓ | | | | : | | | | | | | | | | | | : | | |
| | bright | 0 | 0 | 0 | 0 | 0 | 0 | 1 | 1 | 1 | 1 | 0 | 1 | 0 | 0 | 0 | 0 | 0 | 0 |
| | 0 | 0 | 0 | 0 | 0 | 0 | 1 | 1 | 1 | 1 | 1 | 0 | 0 | 0 | 0 | 0 | 0 | 0 | |
| | 0 | 0 | 0 | 0 | 0 | 0 | 1 | 1 | 1 | 1 | 1 | 1 | 0 | 0 | 0 | 0 | 0 | 0 | |
| Blue scale | Black | 0 | 0 | 0 | 0 | 0 | 0 | 0 | 0 | 0 | 0 | 0 | 0 | 0 | 0 | 0 | 0 | 0 | 0 |
| | | 0 | 0 | 0 | 0 | 0 | 0 | 0 | 0 | 0 | 0 | 0 | 0 | 0 | 0 | 0 | 0 | 0 | 1 |
| | dark | 0 | 0 | 0 | 0 | 0 | 0 | 0 | 0 | 0 | 0 | 0 | 0 | 0 | 0 | 0 | 0 | 1 | 0 |
| | ↑ | | | | : | | | | | | | | | | | | : | | |
| | ↓ | | | | : | | | | | | | | | | | | : | | |
| | bright | 0 | 0 | 0 | 0 | 0 | 0 | 0 | 0 | 0 | 0 | 0 | 0 | 1 | 1 | 1 | 1 | 0 | 1 |
| | 0 | 0 | 0 | 0 | 0 | 0 | 0 | 0 | 0 | 0 | 0 | 0 | 1 | 1 | 1 | 1 | 1 | 0 | |
| | 0 | 0 | 0 | 0 | 0 | 0 | 0 | 0 | 0 | 0 | 0 | 0 | 1 | 1 | 1 | 1 | 1 | 1 | |

4.7 DISPLAY POSITIONS

The following table is the coordinates per pixel (See "4.8 SCANNING DIRECTIONS".).

| | | | | | | | | | | | | | |
|---------------------------------------------------------------------------------------------------------------------------------------------------------------------------------------|-----------|-----|-----------|-----|------------|------------|---|---|---|--|--|--|--|
| C (0, 0) | | | | | | | | | | | | | |
| <table border="1" style="margin: auto;"> <tr> <td style="padding: 2px;">R</td> <td style="padding: 2px;">G</td> <td style="padding: 2px;">B</td> <td colspan="4"></td> </tr> </table> | | | | | | | R | G | B | | | | |
| R | G | B | | | | | | | | | | | |
| ↑ | | | | | | | | | | | | | |
| C(0, 0) | C(1, 0) | ... | C(X, 0) | ... | C(638, 0) | C(639, 0) | | | | | | | |
| C(0, 1) | C(1, 1) | ... | C(X, 1) | ... | C(638, 1) | C(639, 1) | | | | | | | |
| ⋮ | ⋮ | ⋮ | ⋮ | ⋮ | ⋮ | ⋮ | | | | | | | |
| C(0, Y) | C(1, Y) | ... | C(X, Y) | ... | C(638, Y) | C(639, Y) | | | | | | | |
| ⋮ | ⋮ | ⋮ | ⋮ | ⋮ | ⋮ | ⋮ | | | | | | | |
| C(0,478) | C(1,478) | ... | C(X,478) | ... | C(638,478) | C(639,478) | | | | | | | |
| C(0,479) | C(1,479) | ... | C(X,479) | ... | C(638,479) | C(639,479) | | | | | | | |

4.8 SCANNING DIRECTIONS

The following figures are seen from a front view. Also the arrow shows the direction of scan.

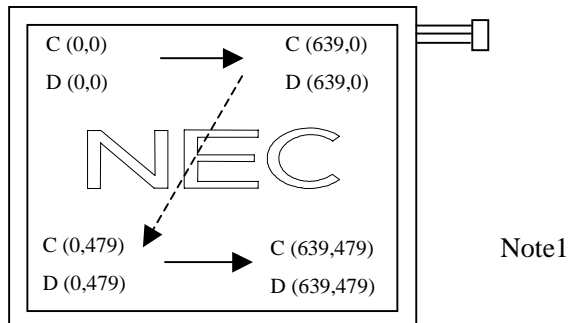

Figure 1. Normal scan (DPS: Low or Open)

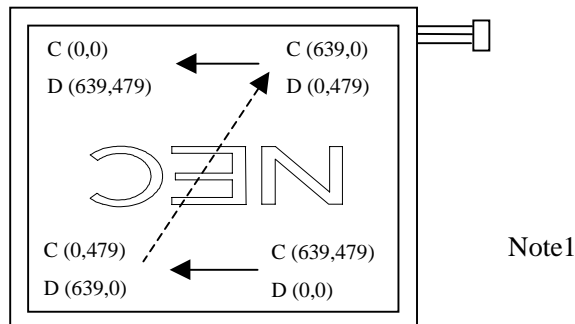

Figure 2. Reverse scan (DPS: High)

Note1: Meaning of C (X, Y) and D (X, Y)

C (X, Y): The coordinates of the display position (See "4.7 DISPLAY POSITIONS".)

D (X, Y): The data number of input signal for LCD panel signal processing board

4.9 INPUT SIGNAL TIMINGS FOR LCD PANEL SIGNAL PROCESSING BOARD

4.9.1 Outline of input signal timings

• Horizontal signal

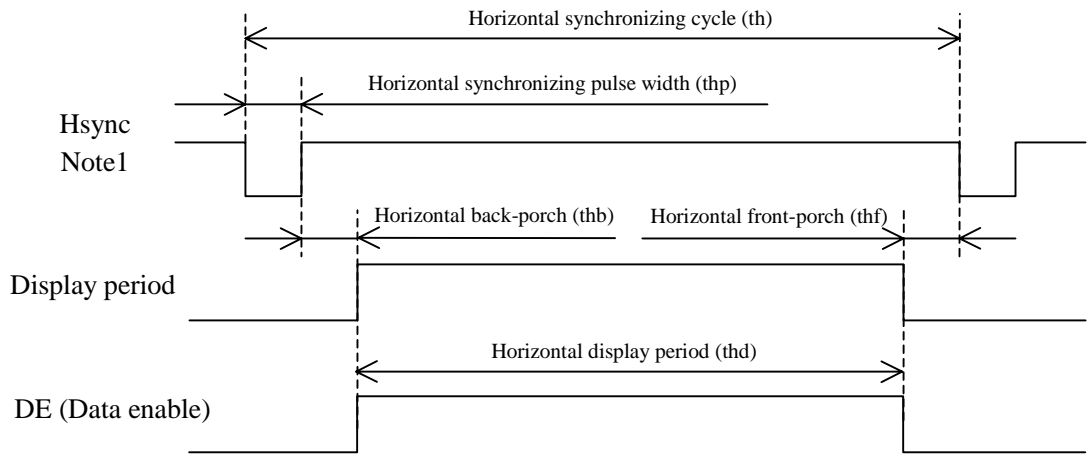

Note1: Fixed mode cannot be used while working of DE mode.
 Note2: This diagram indicates virtual signal for set up to timing.

• Vertical signal

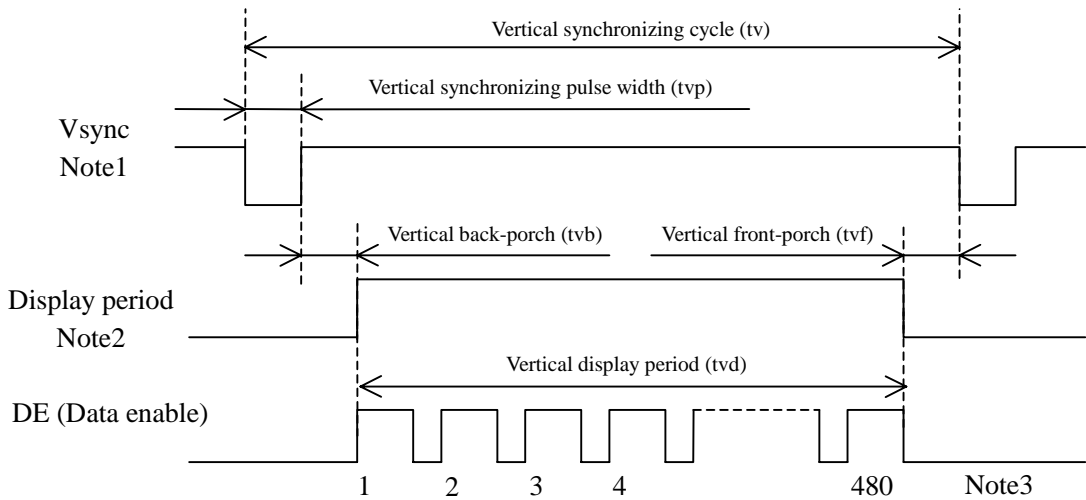

Note1: Fixed mode cannot be used while working of DE mode.
 Note2: This diagram indicates virtual signal for set up to timing.
 Note3: See "4.9.3 Input signal timing chart" for numeration of pulse.

4.9.2 Timing characteristics

(a) Fixed mode

(Note1)

| Parameter | | Symbol | min. | typ. | max. | Unit | Remarks |
|---------------------------------------|-------------------------------------|------------|------|--------|------|---------|-------------------|
| CLK | Frequency | 1/tc | 21.0 | 25.175 | 29.0 | MHz | 39.72 ns (typ.) |
| | Duty | tcd | 0.4 | 0.5 | 0.6 | - | - |
| | Rise time, Fall time | tcrf | - | - | 10 | ns | - |
| DATA (R0-R5) (G0-G5) (B0-B5) | CLK-DATA | Setup time | tds | 8 | - | - | ns |
| | | Hold time | tdh | 12 | - | - | ns |
| | Rise time, Fall time | tdrf | - | - | 10 | ns | - |
| Hsync | Cycle | th | 30.0 | 31.778 | 33.6 | μ s | 31.468 kHz (typ.) |
| | | | 800 | | | CLK | Note2 |
| | Display period | thd | 640 | | | CLK | |
| | Front-porch | thf | 16 | | | CLK | |
| | Pulse width | thp | 10 | 96 | - | CLK | |
| | Back-porch | thb | - | 48 | 134 | CLK | |
| | Total of pulse width and back-porch | thp + thb | 144 | | | CLK | |
| | CLK- Hsync | Setup time | ths | 8 | - | - | ns |
| | | Hold time | thh | 12 | - | - | ns |
| | Rise time, Fall time | thrf | - | - | 10 | ns | - |
| Vsync | Cycle | tv | 16.1 | 16.683 | 17.2 | ms | 59.94 Hz (typ.) |
| | | | 525 | | | H | Note2 |
| | Display period | tvd | 480 | | | H | |
| | Front-porch | tvf | 12 | | | H | |
| | Pulse width | tvp | 1 | 2 | - | H | |
| | Back-porch | tvb | - | 31 | 32 | H | |
| | Total of pulse width and back-porch | tvp + tvb | 33 | | | H | |
| | Hsync-Vsync timing | thv | 1 | - | - | CLK | |
| | Vsync-Hsync timing | tvh | 30 | - | - | ns | |
| | Rise time, Fall time | tvr | - | - | 10 | ns | - |

Note1: Definition of parameters is as follows.

$$tc = 1CLK, tcd = tch/tc, th = 1H$$

Note2: Keep tvp + tvb and thp + thb within the table. If it is out of specification, display position will be shifted to right/left side or up/down.

(b) DE mode

(Note1, Note2)

| Parameter | | Symbol | min. | typ. | max. | Unit | Remarks | |
|---------------------------------------|-------------------------|----------------|-------|--------|--------|------|-----------------|-------------------|
| CLK | Frequency | 1/tc | 21.0 | 25.175 | 29.0 | MHz | 39.72 ns (typ.) | |
| | Duty | tcd | 0.4 | 0.5 | 0.6 | - | - | |
| | Rise time, Fall time | tcrf | - | - | 10 | ns | - | |
| DATA (R0-R5) (G0-G5) (B0-B5) | CLK-DATA | Setup time | tds | 8 | - | - | ns | - |
| | | Hold time | tdh | 12 | - | - | ns | |
| | Rise time, Fall time | tdrf | - | - | 10 | ns | | |
| Vsync | Pulse width | | tvp | 1 | 2 | - | H | - |
| | Vsync-DE timing | Setup time | tvds | 1 | - | - | CLK | |
| | | Hold time | tvdh | 1 | - | - | CLK | |
| | Rise time, Fall time | | tvrfr | - | - | 10 | μs | |
| DE | Horizontal | Cycle | th | 30.0 | 31.778 | 33.6 | μs | 31.468 kHz (typ.) |
| | | | - | - | 800 | - | CLK | - |
| | | Display period | thd | 640 | | | CLK | - |
| | Vertical (One frame) | Cycle | tv | 16.1 | 16.683 | 17.2 | ms | 59.94 Hz (typ.) |
| | | | - | - | 525 | - | H | - |
| | | Display period | tvd | 480 | | | H | - |
| | CLK-DE | Setup time | tdes | 8 | - | - | ns | - |
| Hold time | | tdeh | 12 | - | - | ns | | |
| | Rise time, Fall time | | tderf | - | - | 10 | ns | |

Note1: Definition of parameters is as follows.

$$tc = 1\text{CLK}, tcd = tch/tc, th = 1H$$

Note2: Hsync signal (Pin No.3 of CN1) is not used inside the product at DE mode.

Do not keep pin open to avoid noise problem.

4.9.3 Input signal timing chart

(a) Fixed mode

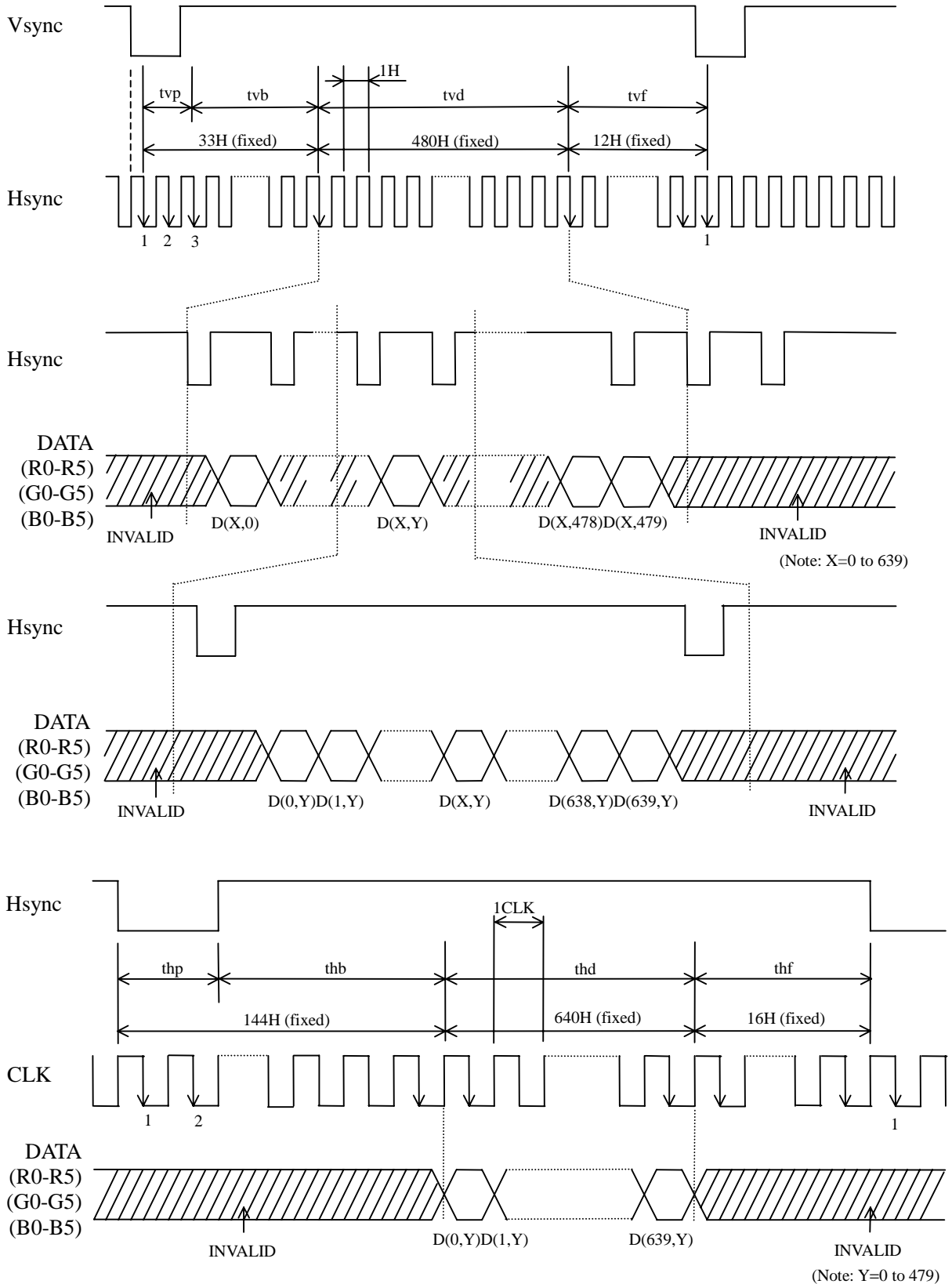

(b) DE mode

Horizontal timing

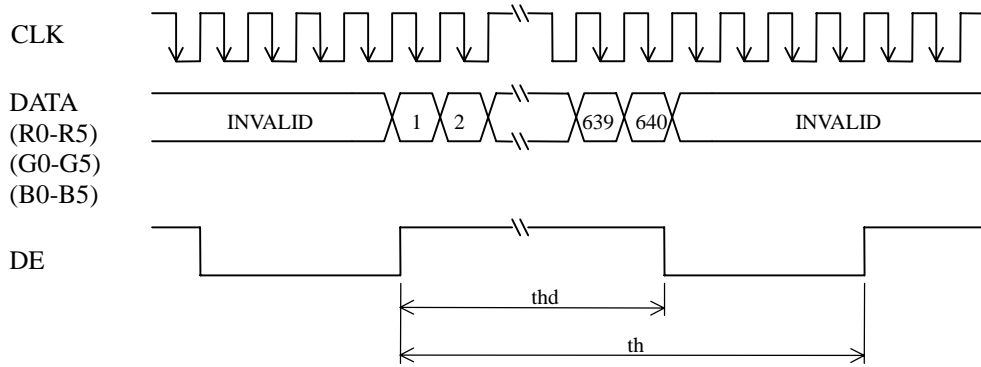

Vertical timing

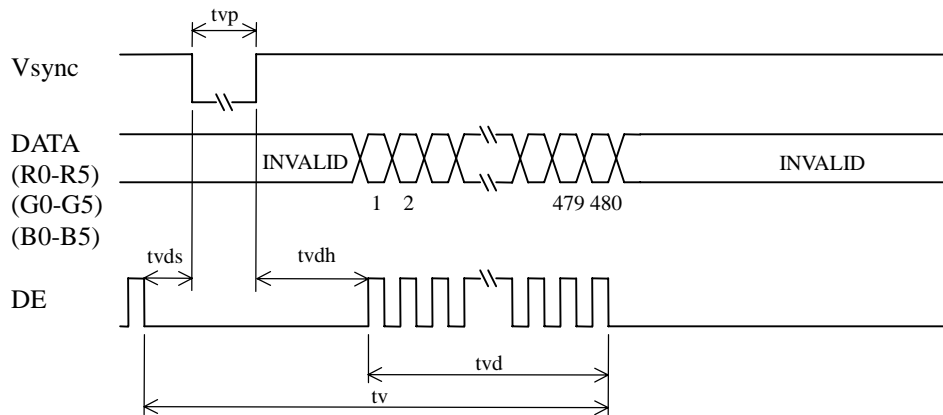

(c) Common

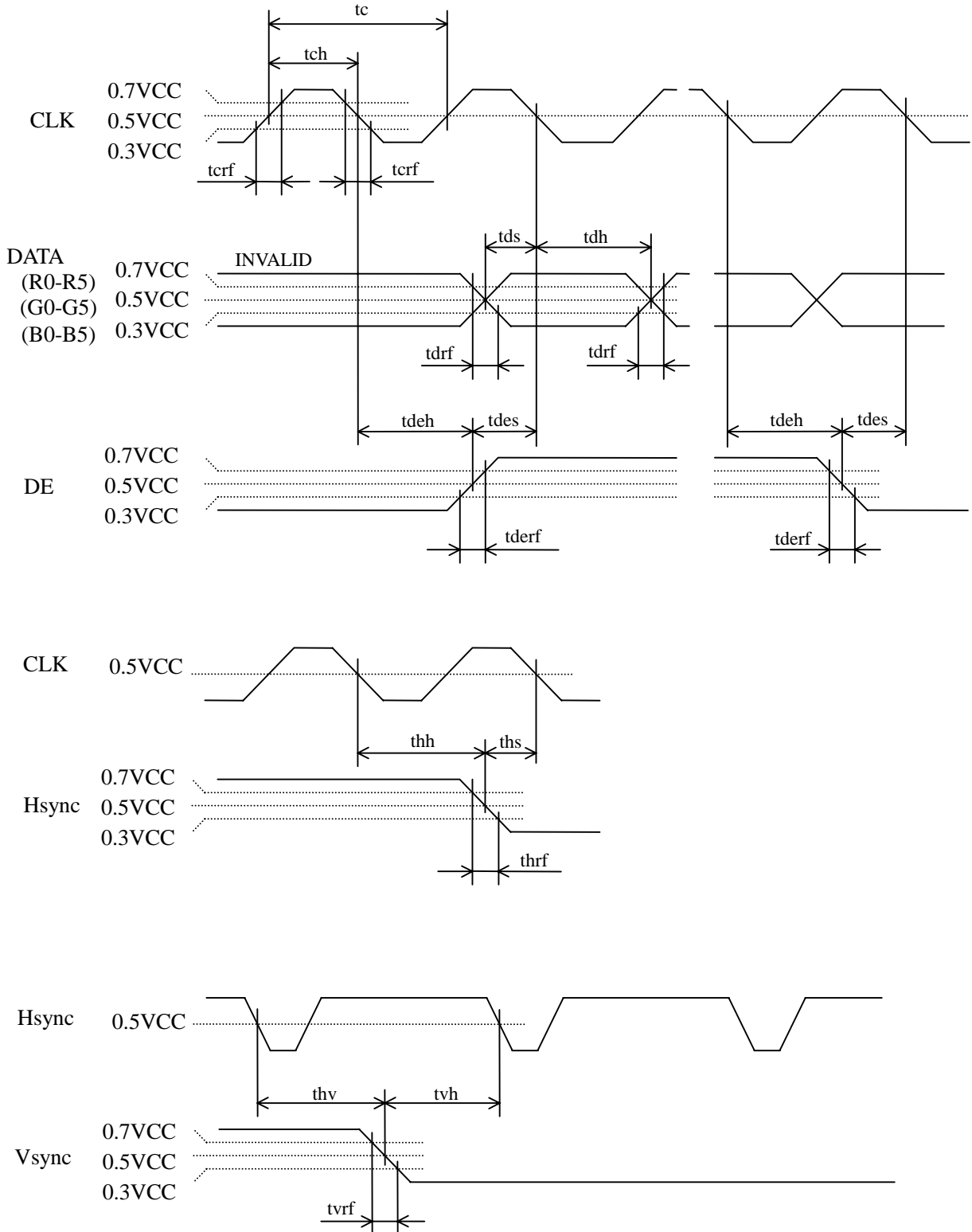

4.10 OPTICS

4.10.1 Optical characteristics

| Parameter | Note1 | Condition | Symbol | min. | typ. | max. | Unit | Remarks |
|----------------------|-------|-------------------------------------------------------------------------------------------------------------------------|------------|-------|-------|-------|-------------------|----------------|
| Luminance | | White at center $\theta R = 0^\circ, \theta L = 0^\circ, \theta U = 0^\circ, \theta D = 0^\circ$ | L | 150 | 220 | - | cd/m ² | - |
| Contrast ratio | | White/Black at center $\theta R = 0^\circ, \theta L = 0^\circ, \theta U = 0^\circ, \theta D = 0^\circ$ | CR | 150 | 350 | - | - | Note2 |
| Luminance uniformity | | - | LU | - | 1.25 | 1.40 | - | Note3 |
| Chromaticity | White | x coordinate | Wx | 0.256 | 0.286 | 0.316 | - | Note4 |
| | | y coordinate | Wy | 0.290 | 0.320 | 0.350 | - | |
| | Red | x coordinate | Rx | - | 0.580 | - | - | |
| | | y coordinate | Ry | - | 0.332 | - | - | |
| | Green | x coordinate | Gx | - | 0.293 | - | - | |
| | | y coordinate | Gy | - | 0.536 | - | - | |
| | Blue | x coordinate | Bx | - | 0.146 | - | - | |
| | | y coordinate | By | - | 0.119 | - | - | |
| Color gamut | | $\theta R = 0^\circ, \theta L = 0^\circ, \theta U = 0^\circ, \theta D = 0^\circ$ at center, against NTSC color space | C | 35 | 40 | - | % | |
| Response time | | White to Black | Ton | - | 15 | 40 | ms | Note5 Note6 |
| | | Black to White | Toff | - | 23 | 85 | ms | |
| Viewing angle | Right | $\theta U = 0^\circ, \theta D = 0^\circ, CR = 10$ | θR | 35 | 45 | - | ° | Note7 |
| | Left | $\theta U = 0^\circ, \theta D = 0^\circ, CR = 10$ | θL | 35 | 45 | - | ° | |
| | Up | $\theta R = 0^\circ, \theta L = 0^\circ, CR = 10$ | θU | 20 | 30 | - | ° | |
| | Down | $\theta R = 0^\circ, \theta L = 0^\circ, CR = 10$ | θD | 10 | 20 | - | ° | |

Note1: Measurement conditions are as follows.

Ta=25°C, VCC=3.3V, IBL= 5.0mA/lamp, Display mode: VGA, Horizontal cycle = 31.468kHz, Vertical cycle = 59.94Hz, DPS= Low or Open: Normal scan

Optical characteristics are measured at luminance saturation after 20minutes from working the product, in the dark room. Also measurement method for luminance is as follows.

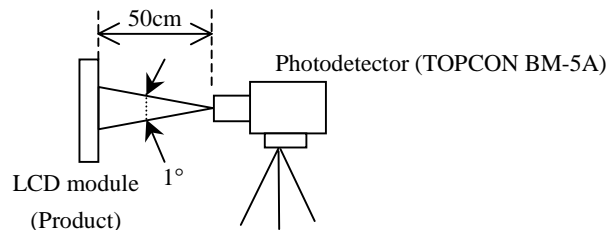

Note2: See "4.10.2 Definition of contrast ratio".

Note3: See "4.10.3 Definition of luminance uniformity".

Note4: These coordinates are found on CIE 1931 chromaticity diagram.

Note5: Product surface temperature: TopF = 31°C

Note6: See "4.10.4 Definition of response times".

Note7: See "4.10.5 Definition of viewing angles".

4.10.2 Definition of contrast ratio

The contrast ratio is calculated by using the following formula.

$$\text{Contrast ratio (CR)} = \frac{\text{Luminance of white screen}}{\text{Luminance of black screen}}$$

4.10.3 Definition of luminance uniformity

The luminance uniformity is calculated by using following formula.

$$\text{Luminance uniformity (LU)} = \frac{\text{Maximum luminance from ① to ⑤}}{\text{Minimum luminance from ① to ⑤}}$$

The luminance is measured at near the 5 points shown below.

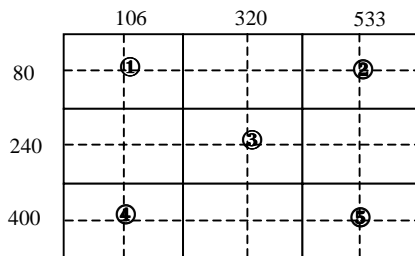

4.10.4 Definition of response times

Response time is measured, the luminance changes from "white" to "black", or "black" to "white" on the same screen point, by photo-detector. Ton is the time it takes the luminance change from 90% down to 10%. Also Toff is the time it takes the luminance change from 10% up to 90% (See the following diagram.).

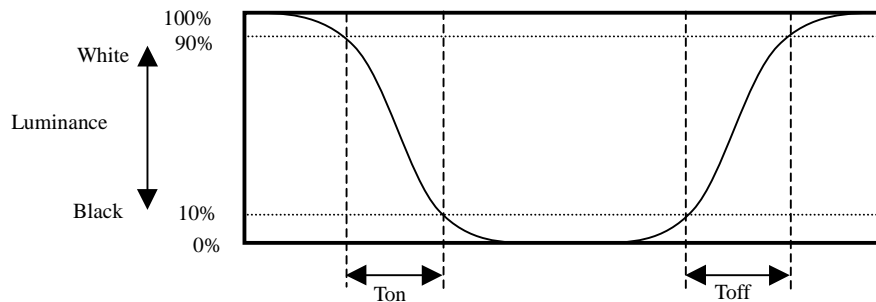

4.10.5 Definition of viewing angles

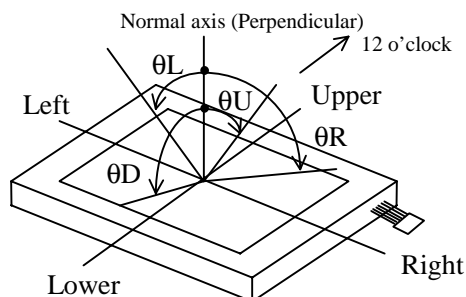

5. RELIABILITY TESTS

| Test item | Condition | Judgement |
|-------------------------------------------|-----------------------------------------------------------------------------------------------------------------------------------|---------------------------------------------------------|
| High temperature and humidity (Operation) | ① 60 ± 2°C, RH = 90%, 240hours ② Display data is black. | No display malfunctions Note1 |
| High temperature (Operation) | ① 70 ± 2°C, 240hours ② Display data is black. | |
| Heat cycle (Operation) | ① -10 ± 3°C...1hour 70 ± 3°C...1hour ② 50cycles, 4hours/cycle ③ Display data is black. | |
| Thermal shock (Non operation) | ① -20 ± 3°C...30minutes 80 ± 3°C...30minutes ② 100cycles, 1hour/cycle ③ Temperature transition time is within 5 minutes. | |
| ESD (Operation) | ① 150pF, 150Ω, ±10kV ② 9 places on a panel surface Note2 ③ 10 times each places at 1 sec interval | |
| Dust (Operation) | ① Sample dust: No. 15 (by JIS-Z8901) ② 15 seconds stir ③ 8 times repeat at 1 hour interval | |
| Vibration (Non operation) | ① 5 to 100Hz, 19.6m/s ² ② 1 minute/cycle ③ X, Y, Z direction ④ 120 times each directions | No display malfunctions No physical damages Note1 |
| Mechanical shock (Non operation) | ① 539m/ s ² , 11ms ② ±X, ±Y, ±Z direction ③ 5 times each directions | |

Note1: Display and appearance are checked under environmental conditions equivalent to the inspection conditions of defect criteria. ☆

Note2: See the following figure for discharge points.

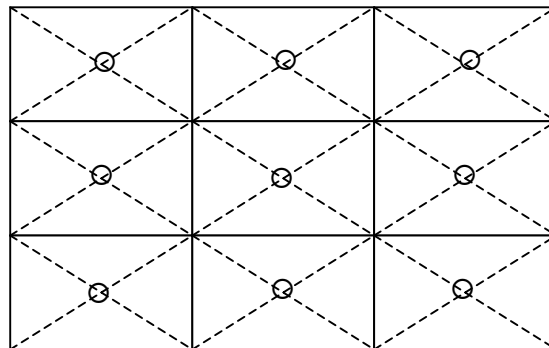



6. PRECAUTIONS

6.1 MEANING OF CAUTION SIGNS

The following caution signs have very important meaning. **Be sure to read "10.2 CAUTIONS" and "10.3 ATTENTIONS", after understanding this contents!**

| | |
|-----------------------------------------------------------------------------------|--------------------------------------------------------------------------------------------------------------------------------------------|
|  | This sign has the meaning that customer will be injured by himself or the product will sustain a damage, if customer has wrong operations. |
|-----------------------------------------------------------------------------------|--------------------------------------------------------------------------------------------------------------------------------------------|

| | |
|-----------------------------------------------------------------------------------|---------------------------------------------------------------------------------------------------------|
|  | This sign has the meaning that customer will get an electrical shock, if customer has wrong operations. |
|-----------------------------------------------------------------------------------|---------------------------------------------------------------------------------------------------------|

| | |
|-----------------------------------------------------------------------------------|-------------------------------------------------------------------------------------------------------|
|  | This sign has the meaning that customer will be injured by himself, if customer has wrong operations. |
|-----------------------------------------------------------------------------------|-------------------------------------------------------------------------------------------------------|

6.2 CAUTIONS

| | |
|-----------------------------------------------------------------------------------|-----------------------------------------------------------------------------------------------|
|  | * Do not touch the working backlight. Customer will be in danger of an electric shock. |
|-----------------------------------------------------------------------------------|-----------------------------------------------------------------------------------------------|

| | |
|-------------------------------------------------------------------------------------|----------------------------------------------------------------------------------------------------------------------------------------------------------------------------------------------------------------------------------------------------------------------------------------------------------------------------------------------------|
|  | <p>* Do not touch the working backlight. Customer will be in danger of burn injury.</p> <p>* Do not shock and press the LCD panel and the backlight! There is a danger of breaking, because they are made of glass. (Shock: To be not greater 539m/s² and to be not greater 11ms, Pressure: To be not greater 19.6 N)</p> |
|-------------------------------------------------------------------------------------|----------------------------------------------------------------------------------------------------------------------------------------------------------------------------------------------------------------------------------------------------------------------------------------------------------------------------------------------------|

6.3 ATTENTIONS



6.3.1 Handling of the product

- ① Take hold of both ends without touch the circuit board cover when customer pulls out products (LCD modules) from inner packing box. If customer touches it, products may be broken down or out of adjustment, because of stress to mounting parts.
- ② Do not hook cables nor pull connection cables such as lamp cable and so on, for fear of damage.
- ③ If customer puts down the product temporarily, the product puts on flat subsoil as a display side turns down.
- ④ Take the measures of electrostatic discharge such as earth band, ionic shower and so on, when customer deals with the product, because products may be damaged by electrostatic.
- ⑤ The torque for mounting screws must never exceed 0.294N·m. Higher torque values might result in distortion of the bezel.
- ⑥ The product must be installed using mounting holes without undue stress such as bends or twist (See outline drawings). And do not add undue stress to any portion (such as bezel flat area) except mounting hole portion.
Bends or twist described above and undue stress to any portion except mounting hole portion may cause display un-uniformity.

- ⑦ Do not press or rub on the sensitive display surface. If customer clean on the panel surface, NEC recommends using the cloth with ethanolic liquid such as screen cleaner for LCD.
- ⑧ Do not push-pull the interface connectors while the product is working, because wrong power sequence may break down the product.
- ⑨ Do not bend or unbend the lamp cable at the near part of the lamp holding rubber, to avoid the damage for high voltage side of the lamp. This damage may cause a lamp breaking and abnormal operation of high voltage circuit.

6.3.2 Environment

- ① Do not operate or store in high temperature, high humidity, dewdrop atmosphere or corrosive gases. Keep the product in antistatic pouch in room temperature, because of avoidance for dusts and sunlight, if customer stores the product.
- ② In order to prevent dew condensation occurring by temperature difference, the product packing box must be opened after leave under the environment of an unpacking room temperature enough. Because a situation of dew condensation occurring is changed by the environmental temperature and humidity, evaluate the leaving time sufficiently. (Recommendation leaving time: 6 hour or more with packing state)
- ③ Do not operate in high magnetic field. Circuit boards may be broken down by it.
- ④ This product is not designed as radiation hardened.
- ⑤ Use an original protection sheet on the product surface (polarizer). Adhesive type protection sheet should be avoided, because it may change color or properties of the polarizer.

6.3.3 Characteristics

The following items are neither defects nor failures.

- ① Response time, luminance and color may be changed by ambient temperature.
- ② The LCD may be seemed luminance non-uniformity, flicker, vertical seam or small spot by display patterns.
- ③ Optical characteristics (e.g. luminance, display uniformity, etc.) gradually is going to change depending on operating time, and especially low temperature, because the LCD has cold cathode fluorescent lamps.
- ④ Do not display the fixed pattern for a long time because it may cause image sticking. Use a screen saver, if the fixed pattern is displayed on the screen.
- ⑤ The display color may be changed by viewing angle because of the use of condenser sheet in the backlight.
- ⑥ Optical characteristics may be changed by input signal timings.
- ⑦ The interference noise of input signal frequency for this product's signal processing board and luminance control frequency of customer's backlight inverter may appear on a display. Set up luminance control frequency of backlight inverter so that the interference noise does not appear.

6.3.4 Other

- ① All GND, backlight inverter ground (GNDB), VCC and backlight inverter power supply voltage (VDDDB) terminals should be used without a non-connected line.
- ② Do not disassemble a product or adjust volume without permission of NEC.
- ③ See "REPLACEMENT MANUAL FOR LAMP HOLDER SET", if customer would like to replace backlight lamps.
- ④ Pay attention not to insert waste materials inside of products, if customer uses screw nails.
- ⑤ Pack the product with original shipping package, because of avoidance of some damages during transportation, when customer returns it to NEC for repair and so on.

7. OUTLINE DRAWINGS

7.1 FRONT VIEW

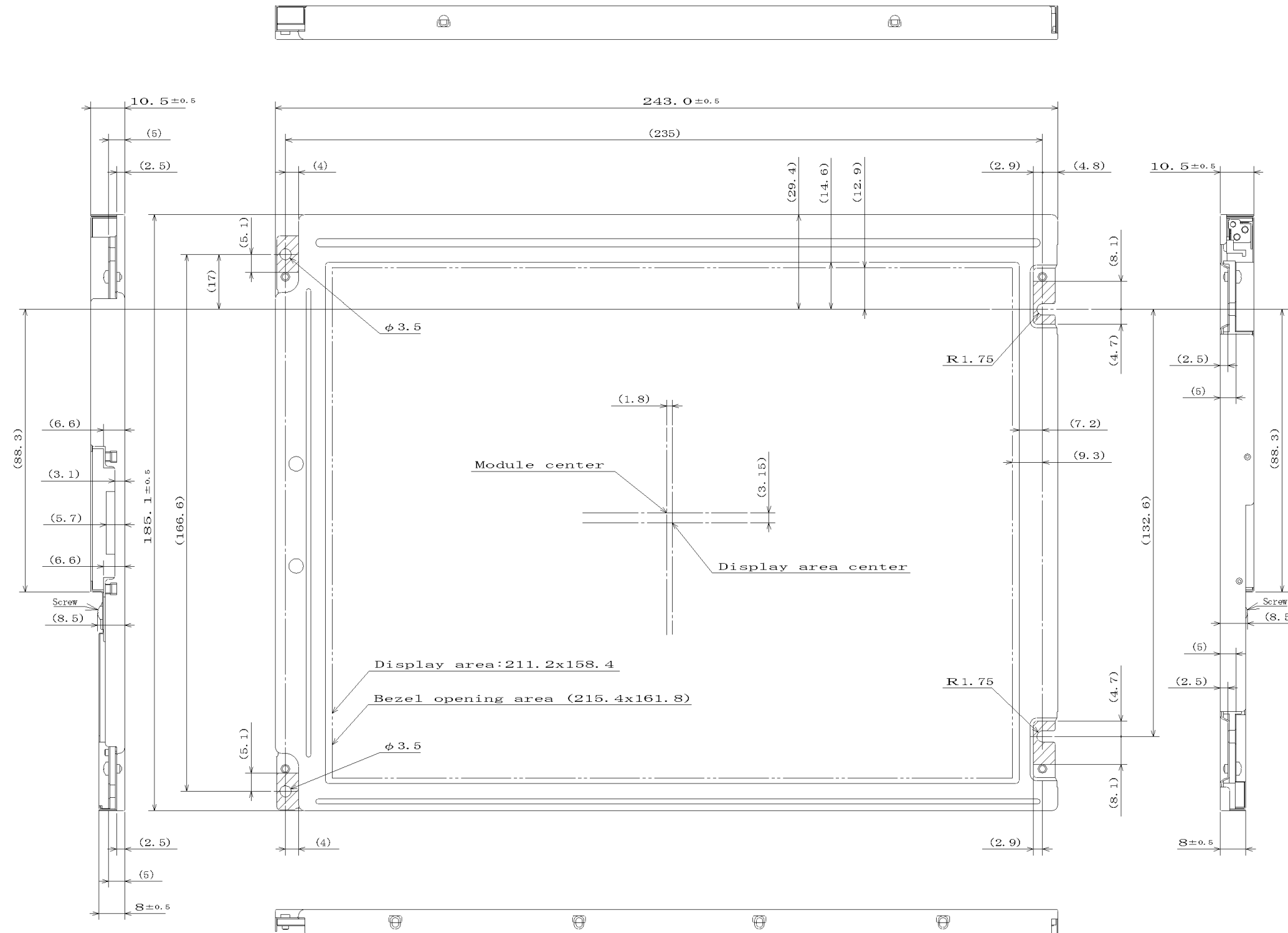

Note1: The values in parentheses are for reference.

Note2: The torque for mounting screws must never exceed 0.294N·m.

Note3:  Mounting hole portions (4 pieces)

Unit: mm

7.2 REAR VIEW

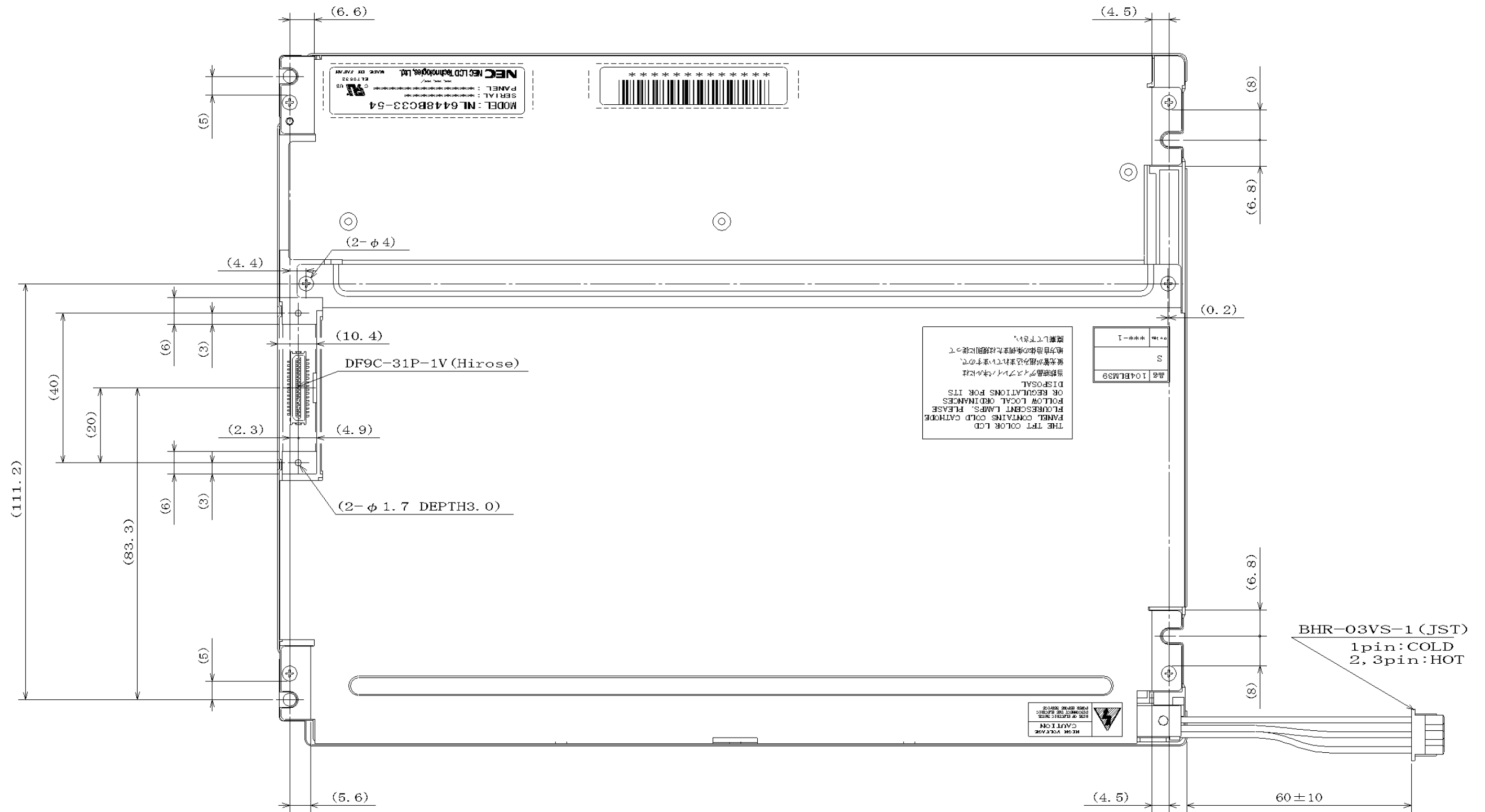

Note1: The values in parentheses are for reference.
 Note2: The torque for mounting screws must never exceed 0.294N·m.

Unit: mm