

## WIDEBAND POWER AMPLIFIER MODULE, 17 - 24 GHz



### Typical Applications

The HMC-C020 Wideband PA is ideal for:

- Microwave Radio & VSAT
- Military & Space
- Test & Lab Instrumentation

### Functional Diagram

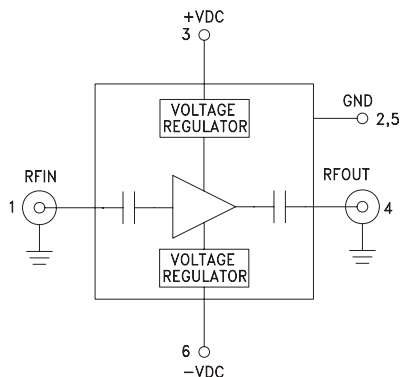

### Features

- Gain: 22 dB
- P1dB Output Power: +24 dBm
- Noise Figure: 3.5 dB
- Spurious-Free Operation
- Regulated Supply and Bias Sequencing
- Hermetically Sealed Module
- Field Replaceable 2.92mm connectors
- 55 to +85°C Operating Temperature

### General Description

The HMC-C020 is a GaAs MMIC PHEMT Power Amplifier in a miniature, hermetic module with replaceable 2.92mm connectors which operates between 17 and 24 GHz. The amplifier provides 22 dB of gain, 3.5 dB noise figure, +33 dBm output IP3 and up to +24 dBm of output power at 1 dB gain compression. The wideband amplifier I/Os are internally matched to 50 Ohms and are DC blocked making the HMC-C020 ideal for EW, ECM RADAR and test equipment applications. Integrated voltage regulators allow for flexible biasing of both the negative and positive supply pins, while internal bias sequencing circuitry assures robust operation.

### Electrical Specifications, $T_A = +25^\circ\text{C}$ , +VDC = +8V to +15V, -VDC = -4V to -10V\*

Parameter	Min.	Typ.	Max.	Min.	Typ.	Max.	Units
Frequency Range	17 - 20		20 - 24				GHz
Gain	19	22	24	19	22	24	dB
Gain Flatness		±1.0			±0.5		dB
Gain Variation Over Temperature		-0.03	-0.04		-0.03	-0.04	dB/°C
Noise Figure		3.5	5.5		4.5	6.5	dB
Input Return Loss		7			7		dB
Output Return Loss		10			10		dB
Output Power for 1 dB Compression (P1dB)	20	23		20	24		dBm
Saturated Output Power (Psat)		25			26		dBm
Output Third Order Intercept (IP3)		33			33		dBm
Positive Supply Current (+IDC)		250			250		mA
Negative Supply Current (-IDC)		5.2			5.2		mA

\* Data recorded at +Vdc = +12V and -Vdc = -5V

## WIDEBAND POWER AMPLIFIER MODULE, 17 - 24 GHz

**Gain & Return Loss**

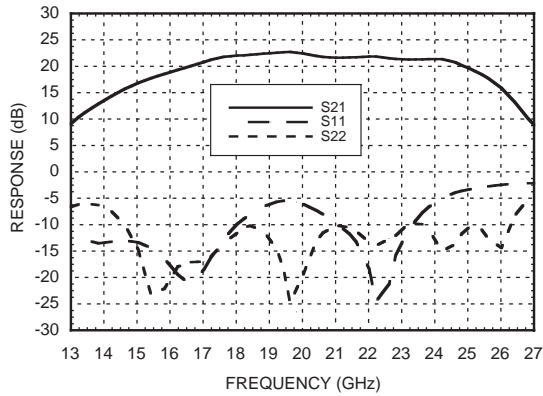

**Gain vs. Temperature**

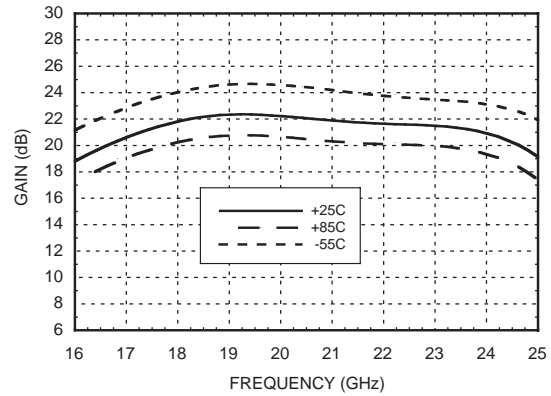

**Input Return Loss vs. Temperature**

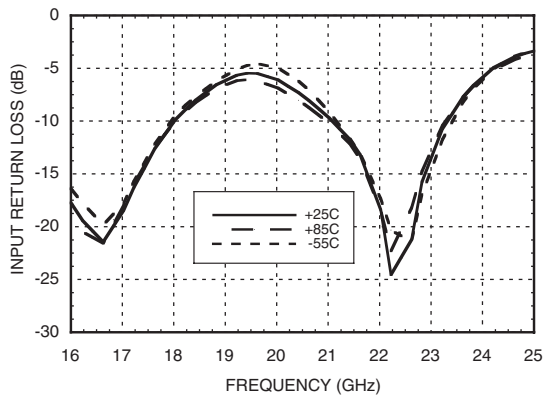

**Output Return Loss vs. Temperature**

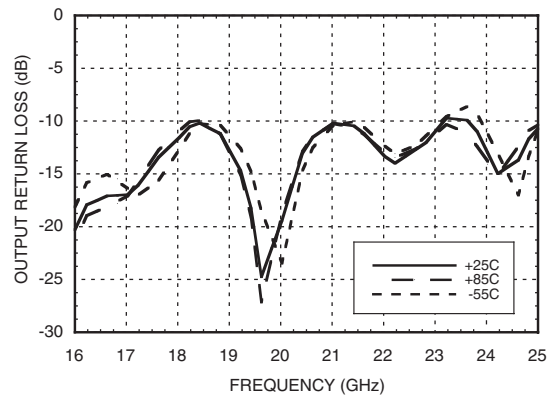

**Reverse Isolation vs. Temperature**

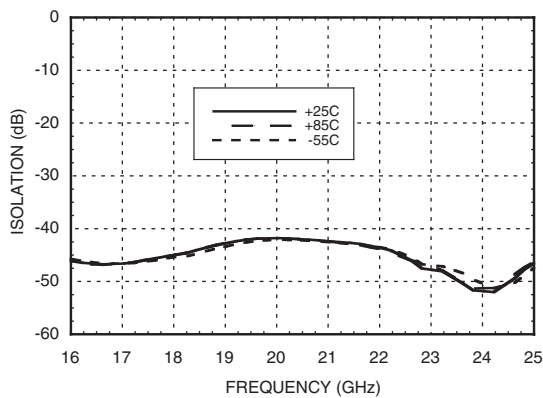

**Noise Figure vs. Temperature**

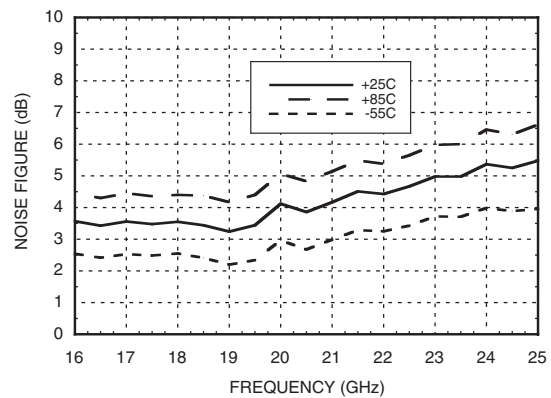

## WIDEBAND POWER AMPLIFIER MODULE, 17 - 24 GHz

**P1dB vs. Temperature**

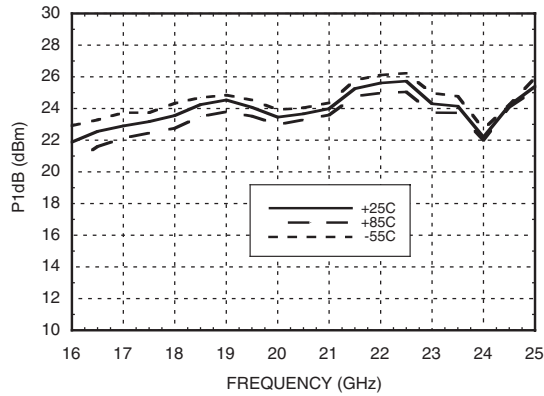

**Psat vs. Temperature**

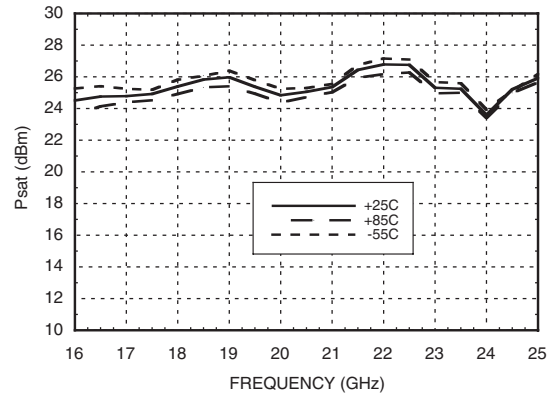

**Output IP3 vs. Temperature**

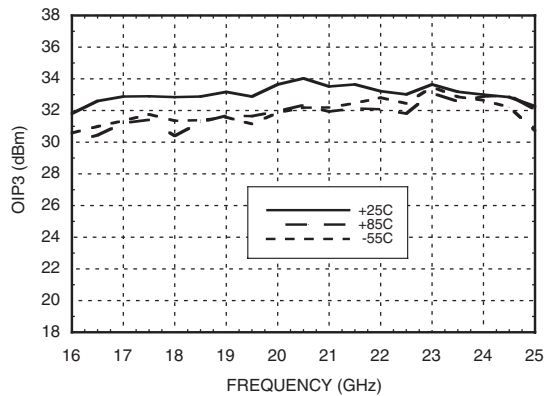

**Absolute Maximum Ratings**



Positive Bias Supply Voltage (+VDC)	+17V Max
Negative Bias Supply (-VDC)	-16V Min.
RF Input Power (RFIn)	+20 dBm
Storage Temperature	-65 to +150 °C
Operating Temperature	-55 to +85 °C



**ELECTROSTATIC SENSITIVE DEVICE  
OBSERVE HANDLING PRECAUTIONS**

**WIDEBAND POWER AMPLIFIER  
MODULE, 17 - 24 GHz**

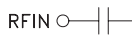
**Pin Descriptions**

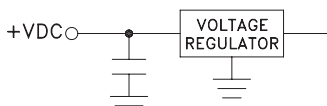
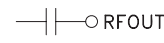
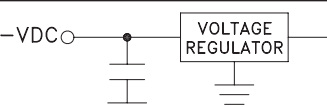
Pin Number	Function	Description	Interface Schematic
1	RFIN	RF input connector, 2.92mm female, field replaceable. This pin is AC coupled and matched to 50 Ohms from 17 - 24 GHz.	
2, 5	GND	Power supply ground.	
3	+VDC	Positive power supply voltage for the amplifier.	
4	RFOUT	RF output connector, 2.92mm female. This pin is AC coupled and matched to 50 Ohms from 17 - 24 GHz.	
6	-VDC	Negative power supply voltage for the amplifier	

**WIDEBAND POWER AMPLIFIER  
MODULE, 17 - 24 GHz**

**Outline Drawing**

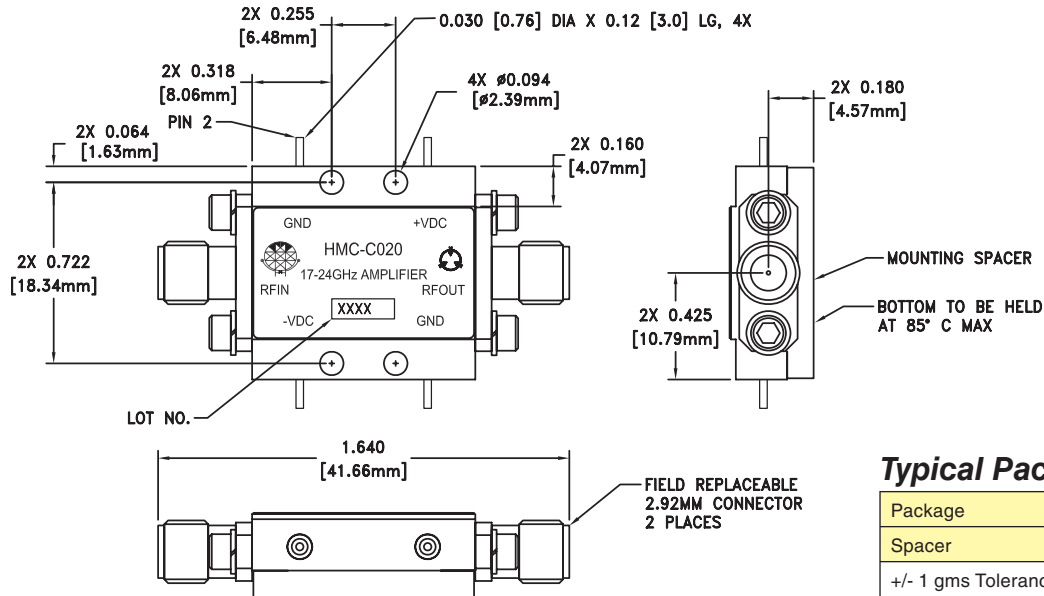

**Typical Package Weight**

Package	18.7 gms
Spacer	3.3 gms
+/- 1 gms Tolerance	

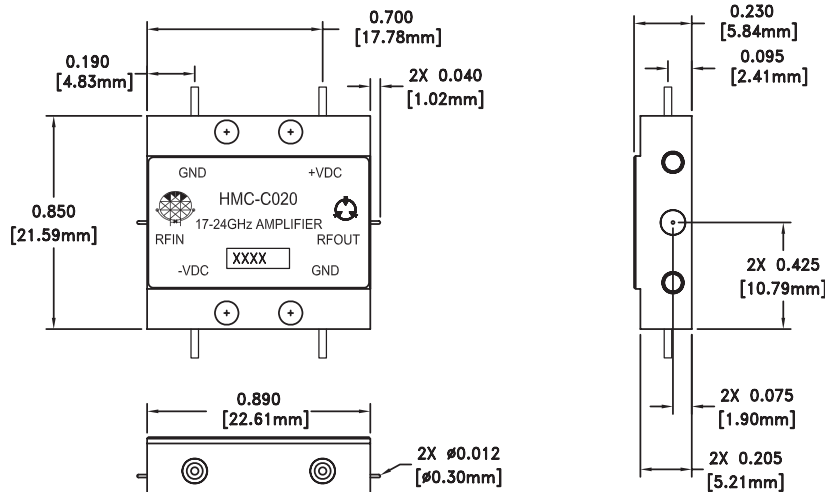

NOTES:

1. PACKAGE, LEADS, COVER MATERIAL: KOVAR™
2. PLATING: ELECTROLYTIC GOLD 50 MICROINCHES MIN., OVER ELECTROLYTIC NICKEL 75 MICROINCHES MIN.
3. SPACER MATERIAL: NICKEL PLATED ALUMINUM
4. ALL DIMENSIONS ARE IN INCHES [MILLIMETERS].
5. TOLERANCES  $\pm$ 0.010 [0.25] UNLESS OTHERWISE SPECIFIED.
6. FIELD REPLACEABLE 2.92MM CONNECTORS.

**WIDEBAND POWER AMPLIFIER  
MODULE, 17 - 24 GHz**

**Notes:**